



Serving The Industry For Over 55 Years

817-834-7300 • www.natdoor.com

CONTENTS

PAGE

Controls / Electrical

Receivers, Transmitters, Keyless Entry, Key Switches, Push Buttons, Wire, Wire Nuts

1-6

Fasteners

Nuts, Bolts, Washers, Lags, Tapping Screws, Anchors

7-12

Hardware

Cable, Low Headroom, Angle Iron, Latches, Locks, Handles, Hinges, Rollers

13-44

Lubricants

Door Lubricants, Private Label, Hand Wipes

45-50

Tools

Angle Shears & Punches, Hand Tools, Cable Tools, Sockets

51-62

Weatherseal

Stop Mold, Astragal, Vinyl & Brush Seals, Bottom Seals, Bottom Rails

63-82

Carriage Door

Magnetic Polymer Hardware, Stamped Steel Hardware

83-88

Window Frames

Residential, Commercial

89-118

Design Trim

Residential, Commercial

119-135

Gate Operators

Operators, Transmitters, Sensors

136-138

Appendix

A1-A8

Index

I1-I3

6310 Airport Freeway
Fort Worth, Texas 76117
1-800-628-3667
Visit us online at www.natdoor.com



CONTROLS & ELECTRICAL



CONTROLS / ELECTRICAL

EXTERIOR CONTROL STATION • FLUSH MOUNT
CONTROLS • EXPLOSION PROOF CONTROLS
EMERGENCY EGRESS • FLUSH MOUNT CONTROL
INTERIOR CONTROLS • EXTERIOR CONTROLS
CEILING PULLS • EMERGENCY DISCONNECT
FLUSH BUTTON SWITCHES • LOOP DETECTORS
CABLES • CORD REEL • CONDUCTOR WIRE

Exterior Control Station

- General purpose exterior control stations
- Non-Metallic enclosures
- Includes keyed lockout
- NEMA 4 rated



Stock	Description
150870	3 Button Exterior Control with Lockout

Flush Mount Controls

- Exterior grade controls
- NEMA 4 rated



Stock	Description
150881	3 Button Flush Mount Control
150882	3 Button Flush Mount Control with Lockout

Surface and Flush Mount Keys

- Available in surface and flush mount
- Optional stop button available
- Tamperproof covers
- NEMA 4 rated

Stock	Description
150840	Surface Mount Key Switch
150841	Surface Mount Key Switch with Stop Button
150850	Flush Mount Key Switch
150851	Flush Mount Key Switch with Stop Button
150920	Flush Mount Key Switch - Exterior
150921	Flush Mount Key Switch with Stop Button - Exterior



150840



150841



150850



150851



150920



150921

Emergency Egress

PRH100

Emergency Egress Control

- Handle flush with faceplate
- 15' cable with S-Hook included

Stock	Description
150910	Emergency Egress Control



Explosion Proof Controls

- Explosion proof NEMA 7 and 9 control station



Stock	Description
150820	2 Button Explosion Proof Control Station
150821	3 Button Explosion Proof Control Station

Direct Dial: (817) 834-7300

Flush Mount Controls

- General purpose interior control stations
- Open-Close and Open-Close-Stop models
- NEMA 1 rated



Stock	Description
I50810	Flush Mount 2 Button Control Station
I50811	Flush Mount 3 Button Control Station

Exterior Controls

- NEMA 4 rated



Stock	Description
I50860	1 Button Control Station
I50861	2 Button Control Station
I50862	3 Button Control Station

Post Mount Key

- Post Mount Key Switch
- Exterior post mount key switch
- Single throw center return
- Tamperproof cover
- NEMA 4 rated



Stock	Description
I50930	Post Mount Key Switch

Interior Controls

- NEMA 1 rated



Stock	Description
I50800	1 Button Control Station
I50801	2 Button Control Station
I50802	3 Button Control Station

Mushroom Head

- Mushroom Head Control Momentary Contact
- Non-metallic enclosure
- Momentary contact
- NEMA 4 rated



Stock	Description
I50890	Mushroom Head Momentary Contact Control

Ceiling Pulls

- **I50830** Exterior Ceiling Pull Switch
- SPST: Single Pull/ Single Throw
- H4", W3-3/4", D-2-3/4
- **I50831** Exterior Ceiling Pull Switch
- DPDT: Double Pull/ Double Throw
- H4", W3-3/4", D-2-3/4
- **I50832** Explosion Proof NEMA 7&9
- DPDT: Double Pull/ Double Throw
- H6-1/8", W3", D5"
- NEMA 4 rated

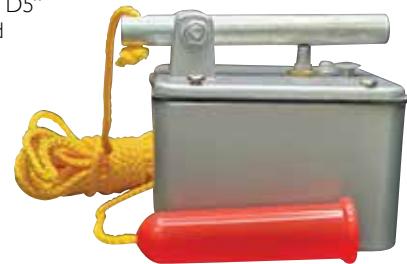

Stock	Description
I50830	Ceiling Pull Switch Exterior SPST
I50831	Ceiling Pull Switch Exterior DPDT
I50832	Ceiling Pull Switch Explosion Proof DPDT

Key Switch

- Comes with steel plate and chrome spiral nails
- Available in 80 different key numbers
- Keys and locks are numbered for easy identification
- Keyed alike or keyed differently
- Hardware included

Stock	Description
150100	National Door Key Switch with Plate



Emergency Disconnect

- 3' long galvanized steel cable
- Available in 80 different key numbers
- Keys and locks are numbered for easy identification
- Keyed alike or keyed differently
- Mounting plate dimensions: 2-1/2" x 1-3/32"

Stock	Description
150405	National Door Emergency Disconnect
150405-KA	National Door Emergency Disconnect - Keyed Alike



Push Button Switches

- Operator push button is flush mounted
- Stainless steel construction

Stock	Description
150500	Operator Push Button



Loop Detectors

- Loop Detectors 110 volt or 24 volt
- Self Tuning — the loop detector automatically tunes up at power on. No manual tuning or maintenance required
- Sensitivity — selectable to minimum, normal or maximum

Stock	Description
150960	110 Volt Loop Detector
150961	24 Volt Loop Detector



Direct Dial: (817) 834-7300

Coil Cords

- Coil cords are 18 gauge SVJEO
- Available in 2, 3, and 4 wire
- Coils extend either 12 or 20 feet

Stock	Description
I50940	2 Wire Coil Cord 2' - Extends 12'
I50941	2 Wire Coil Cord 4' - Extends 20'
I50942	3 Wire Coil Cord 4' - Extends 20'
I50943	4 Wire Coil Cord 4' - Extends 20'



Cord Reel

- Automatic retracting
- Grounded female receptacles
- Swivel mount
- Thermoplastic casing
- Three bare wires to add your own female receptacle or wire to your own device

Stock	Description
I57225	Retractable Cord Reel - 20' 18 AWG



Conductor Wire

- 22 gauge wire
- Suitable for hook-up of push buttons, key switches, key pads, etc.
- Available in 500' carton only

Stock	Description
I51100	Stranded 2 Conductor Wire - White
I51500	Solid 2 Conductor Wire - White
I51501	Solid 4 Conductor Wire - White

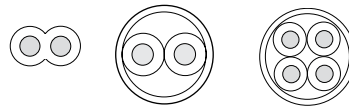

Electrical Plugs

Male/Female Plugs and Connectors

- Yellow impact resistant plastic
- Heavy duty dead front
- Grounded male plug
- Grounded female connector
- 15 amps 125 volts

Stock	Description
I52800	2 Pole Grounded Heavy Duty Male Plug
I52900	2 Pole Grounded Heavy Duty Female Plug



Wire Nuts

- Popular wire nuts are color coded for easy identification
- Blue for wire sizes from 22 to 16 gauge
- Yellow for wire sizes from 14 to 18 gauge
- Red for wire sizes from 14 to 12 gauge
- 100 pieces per box

Stock	Description
I51700	Blue Wire Nuts - 22-16 Gauge
I51800	Yellow Wire Nuts - 18-14 Gauge
I51900	Red Wire Nuts - 14-12 Gauge



Email: sales@natdoor.com



_____ Contact customer service about _____
 special order transmitters.



FASTENERS



FASTENERS

Hex Washer Head Lag Screws

5/16" Hex Washer Head Lag Screw

- Bright Zinc plated finish
- Available in 1 3/4", 2", 2 1/2", and 3" lengths
- Full thread
- Deep indented 7/16" heads

Stock	Description
122100	5/16" x 1 3/4" Hex Washer Lag Screw - Plated - 1250 pcs
122100-250	5/16" x 1 3/4" Hex Washer Lag Screw - Plated - 250 pcs
122103	5/16" x 2" Hex Washer Lag Screw - Plated - 900 pcs
122103-250	5/16" x 2" Hex Washer Lag Screw - Plated - 250 pcs
122106	5/16" x 2 1/2" Hex Washer Lag Screw - Plated - 900 pcs
122106-250	5/16" x 2 1/2" Hex Washer Lag Screw - Plated - 250 pcs
122110	5/16" x 3" Hex Washer Lag Screw - Plated - 700 pcs
122110-100	5/16" x 3" Hex Washer Lag Screw - Plated - 100 pcs



Hex Head Lag Screws

5/16" Hex Head Lag Screw

- Bright Zinc plated finish
- Available in 1 3/4", 2", 2 1/2", and 3" lengths
- 1/2" head
- Non-washer head

Stock	Description
121000	5/16" x 1 3/4" Hex Lag Screw - Plated - 1500 pcs
121000-250	5/16" x 1 3/4" Hex Lag Screw - Plated - 250 pcs
121100	5/16" x 2" Hex Lag Screw - Plated - 1000 pcs
121100-250	5/16" x 2" Hex Lag Screw - Plated - 250 pcs
121200	5/16" x 2 1/2" Hex Lag Screw - Plated - 1000 pcs
121200-250	5/16" x 2 1/2" Hex Lag Screw - Plated - 250 pcs
121300	5/16" x 3" Hex Lag Screw - Plated - 750 pcs
121300-100	5/16" x 3" Hex Lag Screw - Plated - 100 pcs



Hex Washer Lag

1/4" Hex Washer Lags

- 7/16" head
- Bright Zinc plated finish
- Used to fasten hardware to wood doors or in pre-punched steel doors
- Full thread



Stock	Description
121700	1/4" x 1" Wood Lag Screw - Plated - 2500 pcs
121700-250	1/4" x 1" Wood Lag Screw - Plated - 250 pcs

Ribbed Neck Track Bolts

Ribbed Neck Track Bolts

- Bright Zinc plated finish
- Full thread



Stock	Description
128100	1/4"-20 x 5/8" Ribbed Neck Track Bolts - 2500 pcs
128100-250	1/4"-20 x 5/8" Ribbed Neck Track Bolts - 250 pcs
128200	1/4"-20 x 1" Ribbed Neck Track Bolts - 3500 pcs
128200-250	1/4"-20 x 1" Ribbed Neck Track Bolts - 250 pcs

Wood Lag

1/4" Deep Indented Lag

- Non-washer head
- 7/16" head
- Bright Zinc plated finish
- Used to fasten hardware to wood or metal doors.
- Full thread



Stock	Description
122000	1/4" x 1 1/8" Hex Washer Lag Screw - Plated - 2500 pcs
122000-250	1/4" x 1 1/8" Hex Washer Lag Screw - Plated - 250 pcs

Hex Washer Tapping Screw

1/4" Hex Washer Tapping Screw

- 7/16" head
- Bright Zinc plated finish
- Used to fasten hardware to steel doors
- Full thread
- Type AB point.



Stock	Description
121800	1/4" x 5/8" Hex Washer Lag Type AB - Plated - 3000 pcs
121800-250	1/4" x 5/8" Hex Washer Lag Type AB - Plated - 250 pcs

Direct Dial: (817) 834-7300

Drill Point Hex Washer Head Lag

5/16" x 3" Drill Point Hex Washer Head Lag

- Screw drill point
- Bright Zinc plated finish
- Designed to drill through steel, reinforcing plate and wood
- 7/16" washer head
- Recommended for 14-16 gauge or lighter material



Stock	Description
122125	5/16" x 3" Hex Washer Head Lag Screw Drill - 250 pcs
122125-100	5/16" x 3" Hex Washer Head Lag Screw Drill - 100 pcs

Drill-Quick Screws

1/4"-20 Drill-Quick Self Drilling Screw

- 7/16" head
- Bright Zinc plated finish
- Used to fasten hardware to steel doors
- Self-drilling and fastening with a 1/4"- 20 thread



Stock	Description
126912	1/4"-20 x 5/8" Drill-Quick Screws - 3000 pcs
126912-250	1/4"-20 x 5/8" Drill-Quick Screws - 250 pcs
126915	1/4"-20 x 1" Drill-Quick Screws - 2500 pcs
126915-250	1/4"-20 x 1" Drill-Quick Screws - 250 pcs

Tek Screws

- 1/8" Tek screws have 1/4" head
- 5/32" Tek screws have 5/16" head
- 7/16" head is available with 1/4" diameter in both 3/4" and 1" lengths and 5/16" diameter in 1" length
- 1/4" Tek screw has a convex serrated cupped head for tighter grip



Stock	Size	Description
126100	1/8"-8 x 5/8"	Tek Screw - Plated - 1000 pcs
126100-250	1/8"-8 x 5/8"	Tek Screw - Plated - 250 pcs
126200	1/8"-8 x 3/4"	Tek Screw - Plated - 1000 pcs
126200-250	1/8"-8 x 3/4"	Tek Screw - Plated - 250 pcs
126400	5/32"-10 x 3/4"	Tek Screw - Plated - 1000 pcs
126400-250	5/32"-10 x 3/4"	Tek Screw - Plated - 250 pcs
126500	5/32"-10 x 1"	Tek Screw - Plated - 1000 pcs
126500-250	5/32"-10 x 1"	Tek Screw - Plated - 250 pcs
126800	1/4"-14 x 3/4"	Cuphead Serrated Washer - Tek Screw - Plated - 3000 pcs
126800-250	1/4"-14 x 3/4"	Cuphead Serrated Washer - Tek Screw - Plated - 250 pcs
126900	1/4"-14 x 1"	Tek Screw - Plated - 2500 pcs
126900-250	1/4"-14 x 1"	Tek Screw - Plated - 250 pcs
126905	5/16" x 1"	Tek Screw - Plated - 2500 pcs
126905-250	5/16" x 1"	Tek Screw - Plated - 250 pcs

Square Head Set Screws

Square Head Set Screws

- For cable drums and cones



Stock	Description
126970	3/8" x 1" Set Screw for Drums and Cones - 100 pcs
126980	3/8" x 1 1/2" Set Screw for Drums and Cones - 100 pcs
126990	3/8" x 2" Set Screw for Drums and Cones - 100 pcs

Hex Nuts

- Bright Zinc plated finish



Stock	Size	Description
124200	1/4"-20	Hex Nuts - Plated - 2000 pcs
124200-250	1/4"-20	Hex Nuts - Plated - 250 pcs
124300	5/16"-18	Hex Nuts - Plated - 2500 pcs
124300-250	5/16"-18	Hex Nuts - Plated - 250 pcs
124400	3/8"-16	Hex Nuts - Plated - 1500 pcs
124400-250	3/8"-16	Hex Nuts - Plated - 250 pcs

KEP Nuts

- Combination lock and washer nut
- Bright Zinc plated finish



Stock	Size	Description
124700	1/4"-20	KEP Nuts - Plated - 3500 pcs
124700-250	1/4"-20	KEP Nuts - Plated - 250 pcs
124800	5/16"-18	KEP Nuts - Plated - 2000 pcs
124800-250	5/16"-18	KEP Nuts - Plated - 250 pcs
124900	3/8"-16	KEP Nuts - Plated - 1500 pcs
124900-250	3/8"-16	KEP Nuts - Plated - 250 pcs

Flanged Lock Nuts

- Combines washer and nut in a single fastener
- Head is serrated to provide locking
- Bright Zinc plated finish



Stock	Size	Description
124920	1/4"-20	Flanged Lock Nuts - Plated - 3000 pcs
124920-250	1/4"-20	Flanged Lock Nuts - Plated - 250 pcs
124930	5/16"-18	Flanged Lock Nuts - Plated - 2000 pcs
124930-250	5/16"-18	Flanged Lock Nuts - Plated - 250 pcs
124940	3/8"-16	Flanged Lock Nuts - Plated - 1500 pcs
124940-250	3/8"-16	Flanged Lock Nuts - Plated - 250 pcs

Lock Washers

- Spring type split washers
- Bright Zinc plated finish



Stock	Size	Description
125100	1/4"	Lock Washer - Plated - 3000 pcs
125100-250	1/4"	Lock Washer - Plated - 250 pcs
125200	5/16"	Lock Washer - Plated - 2000 pcs
125200-250	5/16"	Lock Washer - Plated - 250 pcs
125300	3/8"	Lock Washer - Plated - 1500 pcs
125300-250	3/8"	Lock Washer - Plated - 250 pcs

Painted Weatherstrip Nails

Painted Weatherseal and Stop Mold Nails

- 1 3/4" length
- Painted white, brown, almond, sandstone, and black
- Double hot dipped zinc coated nails
- Extra holding power and dependable corrosion resistance
- Great for Jamb Up Vinyl Perimeter Stop Mold
- Available in a 10 or 1 pound box
- Made in USA



Stock	Description
135900	1 3/4" Painted Weatherstrip Nails - White - 10 lb box
135900-001	1 3/4" Painted Weatherstrip Nails - White - 1 lb box
135901	1 3/4" Painted Weatherstrip Nails - Brown - 10 lb box
135901-001	1 3/4" Painted Weatherstrip Nails - Brown - 1 lb box
135902	1 3/4" Painted Weatherstrip Nails - Almond - 10 lb box
135902-001	1 3/4" Painted Weatherstrip Nails - Almond - 1 lb box
135904	1 3/4" Painted Weatherstrip Nails - Sandstone - 10 lb box
135904-001	1 3/4" Painted Weatherstrip Nails - Sandstone - 1 lb box
135905-001	1 3/4" Painted Weatherstrip Nails - Black - 1 lb box

Flat Head Carriage Bolts

- Bright Zinc plated finish
- Flat head with square neck
- 1/4"-20 full length thread



Stock	Description
127100	1/4"-20 x 1 7/8" Flat Head Carriage Bolt - 2000 pcs
127100-250	1/4"-20 x 1 7/8" Flat Head Carriage Bolt - 250 pcs
127200	1/4"-20 x 2 1/4" Flat Head Carriage Bolt - 750 pcs
127200-250	1/4"-20 x 2 1/4" Flat Head Carriage Bolt - 250 pcs
127300	1/4"-20 x 2 1/2" Flat Head Carriage Bolt - 1000 pcs
127300-250	1/4"-20 x 2 1/2" Flat Head Carriage Bolt - 250 pcs

Flat Washers

- Bright Zinc plated finish

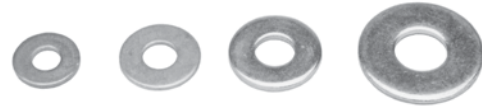

Stock	Description
125400	1/4" Flat Washer - Plated - 3000 pcs
125400-250	1/4" Flat Washer - Plated - 250 pcs
125500	5/16" Flat Washer - Plated - 2000 pcs
125500-250	5/16" Flat Washer - Plated - 250 pcs
125600	3/8" Flat Washer - Plated - 1500 pcs
125600-250	3/8" Flat Washer - Plated - 250 pcs
125603	1/2" Flat Washer - Plated - 1500 pcs
125603-250	1/2" Flat Washer - Plated - 250 pcs

Hex Head Bolts

- All sizes are full thread
- 1/4" bolt has 7/16" head
- 5/16" bolt has 1/2" head
- 3/8" bolt has 9/16" head
- Bright Zinc plated finish



1/4" Hex Bolts



5/16" Hex Bolts



3/8" Hex Bolts

Stock	Description
123000	1/4"-20 x 5/8" Hex Head Bolt - 3000 pcs
123000-250	1/4"-20 x 5/8" Hex Head Bolt - 250 pcs
123300	1/4"-20 x 3/4" Hex Head Bolt - 3750 pcs
123300-250	1/4"-20 x 3/4" Hex Head Bolt - 250 pcs
123500	1/4"-20 x 1" Hex Head Bolt - 3000 pcs
123500-250	1/4"-20 x 1" Hex Head Bolt - 250 pcs
123600	5/16"-18 x 3/4" Hex Head Bolt - 2000 pcs
123600-250	5/16"-18 x 3/4" Hex Head Bolt - 250 pcs
123700	5/16"-18 x 1" Hex Head Bolt - 1800 pcs
123700-250	5/16"-18 x 1" Hex Head Bolt - 250 pcs
123800	3/8"-16 x 3/4" Hex Head Bolt - 1800 pcs
123800-250	3/8"-16 x 3/4" Hex Head Bolt - 250 pcs
123900	3/8"-16 x 1" Hex Head Bolt - 1500 pcs
123900-250	3/8"-16 x 1" Hex Head Bolt - 250 pcs

Direct Dial: (817) 834-7300

Sleeve Anchors

SUP-R-SLEEVE Sleeve Anchor

- Sleeve Anchors are all steel, multi-purpose, bolt size/hole size anchor effective under dead and variable loads in a wide range of materials
- Its unusual versatility arises from the unique slipping sleeve design and it's available in many lengths and sizes
- All bolts S.A.E. Grade 5

Stock	Description
I30100	5/16" x 1 1/2" Sleeve Anchor - 100 pcs
I30200	5/16" x 2 1/2" Sleeve Anchor - 100 pcs
I30300	3/8" x 1 7/8" Sleeve Anchor - 50 pcs
I30400	3/8" x 3" Sleeve Anchor - 50 pcs
I30500	1/2" x 2 1/4" Sleeve Anchor - 25 pcs
I30600	1/2" x 2 3/4" Sleeve Anchor - 25 pcs
I30601	1/2" x 4" Sleeve Anchor - 25 pcs
I30602	1/2" x 6" Sleeve Anchor - 25 pcs
I30800	5/8" x 2 1/4" Sleeve Anchor - 25 pcs
I31000	5/8" x 4 1/4" Sleeve Anchor - 10 pcs
I31200	3/4" x 2 1/2" Sleeve Anchor - 10 pcs
I31300	3/4" x 4 1/4" Sleeve Anchor - 5 pcs
I31400	3/4" x 6" Sleeve Anchor - 5 pcs



Wedge Stud Anchors

SUP-R-STUD Sleeve Anchor

- Superiority in structural anchoring of all types of equipment
- All bolts S.A.E. Grade 5

Stock	Description
I32100	1/4" x 1 3/4" Wedge Anchor - 100 pcs
I32200	1/4" x 2 1/4" Wedge Anchor - 100 pcs
I32300	1/4" x 3 1/4" Wedge Anchor - 100 pcs
I32400	3/8" x 2 1/4" Wedge Anchor - 50 pcs
I32500	3/8" x 3" Wedge Anchor - 50 pcs
I32700	3/8" x 3 3/4" Wedge Anchor - 50 pcs
I32800	3/8" x 5" Wedge Anchor - 50 pcs
I32900	1/2" x 2 3/4" Wedge Anchor - 50 pcs
I33000	1/2" x 4" Wedge Anchor - 50 pcs
I33100	1/2" x 5 1/4" Wedge Anchor - 50 pcs
I33300	1/2" x 7" Wedge Anchor - 25 pcs
I33400	5/8" x 3 1/2" Wedge Anchor - 25 pcs
I33500	5/8" x 5" Wedge Anchor - 25 pcs
I33600	5/8" x 6" Wedge Anchor - 25 pcs
I33700	5/8" x 7" Wedge Anchor - 20 pcs
I33800	5/8" x 8 1/2" Wedge Anchor - 20 pcs
I33900	3/4" x 4 1/4" Wedge Anchor - 20 pcs
I34000	3/4" x 5 1/2" Wedge Anchor - 20 pcs
I34100	3/4" x 7" Wedge Anchor - 15 pcs
I34200	3/4" x 8 1/2" Wedge Anchor - 15 pcs
I34300	3/4" x 10" Wedge Anchor - 15 pcs



Email: sales@natdoor.com

Plastic Drive Anchors

Tap-It

- Functions as a one piece anchor, toggle blind fastener or rivet
- Nylon shell with a steel nail insert designed for light loads in solid masonry, wood or steel
- Great for attaching weatherstrip

Stock	Description
135298	3/16" x 3/4" Nylon Tap-It Drive Anchor - 100 pcs
135299	3/16" x 1" Nylon Tap-It Drive Anchor - 100 pcs
135300	1/4" x 3" Nylon Tap-It Drive Anchor - 100 pcs



Zinc Drive Anchors

Zap-It

- Functions as a one piece anchor, toggle blind fastener or rivet
- Die cast zinc shell with a steel nail insert designed for use in masonry and concrete
- Great for attaching weatherstrip or hardware

Stock	Description
134801	1/4" x 1 1/4" Zinc Zap-It Drive Anchor - 100 pcs
134802	1/4" x 1 1/2" Zinc Zap-It Drive Anchor - 100 pcs
134803	1/4" x 2" Zinc Zap-It Drive Anchor - 100 pcs



Pop Rivets

- Aluminum rivet with aluminum mandrel
- Grip ranges from 0" to 1/2"
- Diameters 3/32", 1/8", 5/32" and 3/16"
- Low rivet profile offers cosmetic advantages over screws
- Used to install weatherstrip, steel backskin and aluminum window frames

Stock	Size	Description
135400	3/32" Dia.	1/32" to 1/8" Grip Pop Rivet - 500 pcs
135401	3/32" Dia.	1/8" to 1/4" Grip Pop Rivet - 500 pcs
135402	1/8" Dia.	1/8" to 3/16" Grip Pop Rivet - 500 pcs
135403	1/8" Dia.	3/16" to 1/4" Grip Pop Rivet - 500 pcs
135404	1/8" Dia.	1/4" to 5/16" Grip Pop Rivet - 500 pcs
135405	1/8" Dia.	5/16" to 3/8" Grip Pop Rivet - 500 pcs
135406	5/32" Dia.	1/16" to 1/8" Grip Pop Rivet - 500 pcs
135407	5/32" Dia.	1/8" to 3/16" Grip Pop Rivet - 500 pcs
135408	5/32" Dia.	3/16" to 1/4" Grip Pop Rivet - 500 pcs
135409	5/32" Dia.	1/4" to 3/8" Grip Pop Rivet - 500 pcs
135410	3/16" Dia.	1/16" to 1/8" Grip Pop Rivet - 500 pcs
135411	3/16" Dia.	1/8" to 1/4" Grip Pop Rivet - 500 pcs
135412	3/16" Dia.	1/4" to 3/8" Grip Pop Rivet - 500 pcs
135413	3/16" Dia.	3/8" to 1/2" Grip Pop Rivet - 500 pcs



Plastic Screw Anchors

- Designed for light duty fastening in concrete or brick masonry

Stock	Description
134400	3/16" x 7/8" Plastic Screw Anchor - 100 pcs
134500	1/4" x 1" Plastic Screw Anchor - 100 pcs
134600	5/16" x 1 3/8" Plastic Screw Anchor - 100 pcs



HARDWARE



HARDWARE

BUTTON STOPS • CABLE CLAMPS • DUPLEX
SHEAVES • SLIDE LATCH • WIDE BODY HINGES
SHEAVES • REDUCED DRIVE CHAIN HOIST •
TENSION SPRINGS WITH CONES • CABLE SPOO
BULK CABLE • ADJUSTABLE REINFORCING
PACKETS • LOCK BARS • ADJUSTABLE SHAF
COUPLERS • STAINLESS STEEL SHAFTS

Button Stops

- Adds stop to cable to prevent pulling through a guide
- 100 pieces per bag
- Made in the USA



Stock	Description
168999	1/16" Aluminum Button Stop
169000	3/32" Aluminum Button Stop
169001	1/8" Aluminum Button Stop
169002	5/32" Aluminum Button Stop
169003	3/16" Aluminum Button Stop
169004	1/4" Aluminum Button Stop

Cable Clamps

- Note: Cable Clamps should NOT be used to repair broken springs
- 50 pieces per pack



Stock	Description
167300	1/8" Cable Clamps
167301	3/16" Cable Clamps
167302	1/4" Cable Clamps
167304	3/8" Cable Clamps

Cable Spools

- For drilled pin bottom fixtures.
- For residential application
- 100 pieces per pack



Stock	Description
167005	Aluminum Cable Spool

Cable Thimbles

- Enhance logevity of the cable by protecting loop ends
- Zinc plated carbon steel
- 100 pieces per bag
- Made in the USA



Stock	Description
168000	3/32" AN Thimble
168001	1/8" AN Thimble
168002	5/32" AN Thimble
168003	3/16" AN Thimble
168004	1/4" AN Thimble

Duplex Sleeves

- Prevent fraying of wire accessory
- Hourglass (duplex) shaped sleeve allow for the smoothest swage (crimp)
- Capable of supporting higher load than rated breaking strength of cable
- 100 pieces per bag
- Made in the USA



Stock	Description
168499	1/16" Aluminum Duplex Oval Sleeve
168500	3/32" Aluminum Duplex Oval Sleeve
168501	1/8" Aluminum Duplex Oval Sleeve
168502	5/32" Aluminum Duplex Oval Sleeve
168503	3/16" Aluminum Duplex Oval Sleeve
168504	1/4" Aluminum Duplex Oval Sleeve

Direct Dial: (817) 834-7300

Bulk Cable - Galvanized Aircraft Cable

GAC Cable Size	Break Strength (lbs.)	Weight per 1,000 foot (lbs.)
7x7	1/16"	920
	3/32"	920
	1/8"	1,700
7x19	1/8"	2,000
	5/32"	2,800
	3/16"	4,200
	1/4"	7,000



Stock	Description
500' Reels Bulk Cable	
I69498	1/16" 7 x 7 GAC Cable
I69500	3/32" 7 x 7 GAC Cable
I69502	1/8" 7 x 7 GAC Cable
I69504	1/8" 7 x 19 GAC Cable
I69506	5/32" 7 x 19 GAC Cable
I69508	3/16" 7 x 19 GAC Cable
I69510	1/4" 7 x 19 GAC Cable



7 Strands
7 Wires
per Strand

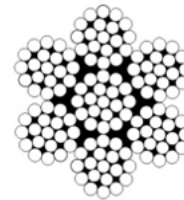

7 Strands
19 Wires
per Strand

7 x 19

Complete Cable Sets

- Sold in pairs

Stock	Description	Box Qty
Extension Spring Cable Sets		
I67910	3/32" - 7 x 7 - 12' 6" 7' Single Door - Blue	25
I67911	1/8" - 7 x 7 - 12' 6" 7' Double Door - Red	25
Torsion Spring Cable Sets		
I67912	1/8" - 7 x 7 - 8' 6" 7' High Door - Orange	25
I67913	1/8" - 7 x 19 - 9' 6" 8' High Door - Green	25
I67914	1/8" - 7 x 19 - 11' 6" 10' High Door - Black	25
I67915	5/32" - 7 x 19 - 13' 6" 12' High Door - Brown	25
I67916	5/32" - 7 x 19 - 15' 6" 14' High Door - Yellow	25



Sliding Bolt Latches

Sliding Bolt Latch

- Bolt is 3/8" diameter
- 2 1/4" of throw
- Security Lock out plate available

Stock	Description	Box Qty
215110	Slide Bolt Keeper	50
215200	Sliding Bolt Latch	50
215201	Lock Out Plate For Sliding Bolt Latch Only	50

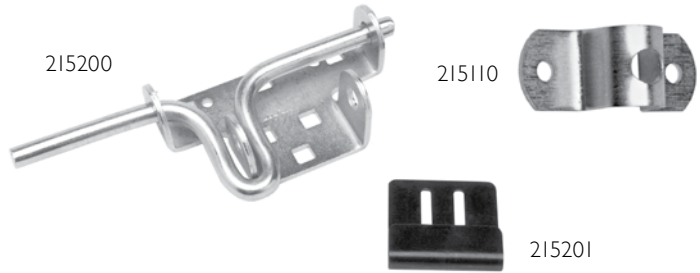

Security Sliding Bolt Latch

- Heavy-Duty Security Slide Bolt
- Ideal for mini-warehouses, prevents the shackle of your padlock from being cut
- Prevents lock tabs from being broken off
- Still allows addition of second padlock
- Front and back plates are 10 gauge steel zinc plated
- Bolt is 1/2" diameter

Stock	Description	Box Qty
215510	Security Slide Bolt Latch	10

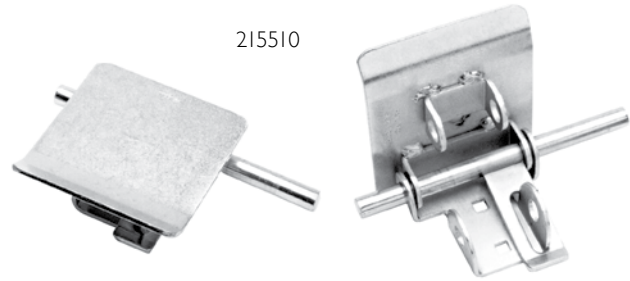

Slide Latch

- Spring activated lock bar
- Bright zinc plated finish
- 214000 - 2" or 3" track, 9 1/4" slide bar length, 2-3/4" travel
- 214010 - 2" track, 6 1/8" slide bar length, 2-1/4" travel

Stock	Description	Box Qty
214000	Side Lock - for 2" or 3" Track	50
214010	Side Lock - for 2" Track	50

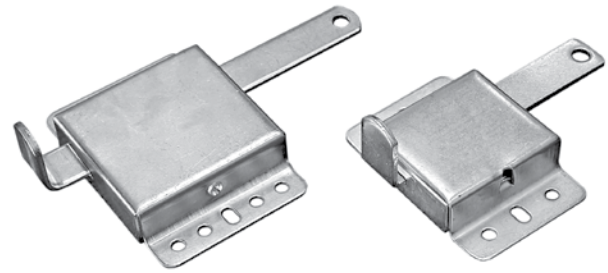

Side Lock Set

- Chrome plated zinc alloy die casting
- 5/16" square shaft - 3 1/2" length
- Includes end stile lock and outside "L" handle with 2 keys and push nuts
- Fasteners not included

Stock	Description	Box Qty
214200	National Complete Side Lock Set	25

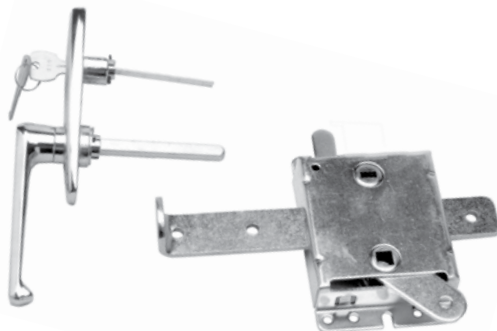

End Stile Lock

- Activated from the the outside when used with Outside Handle below or our Cylinder Lock Set
- Can also be used with either lock bars or cable
- Lock can be reversed for right or left installation
- For 2" or 3" track
- Bright zinc plated finish
- Slide bar length 7 1/2"

Stock	Description	Box Qty
214190	End Stile Locking Latch	25

Outside Handle Only

- Chrome plated zinc alloy die casting
- 5/16" square shaft - 3 1/2" length
- Includes 2 keys

Stock	Description	Box Qty
214190	Outside Handle with 2 keys	25
214192	Blank Keys for Outside Handle	

Direct Dial: (817) 834-7300

Nite Latch & Cylinder Locks

Die Cast Housing

- Keyed alike in lots of 10
- Zinc die cast deadbolt housing
- Includes dead bolt, cylinder assembly, 2 keys, and all fasteners



Stock	Description	Box Qty
214300	Nite Latch Lock, Cast Housing with cylinder & keys	10
214800	Cylinder Lock with 2 keys	10
214301	Blank Keys for Nite Latch and Cylinder Lock	

Cylinder Lock

- Keyed alike in lots of 10
- 2 keys, 2 fasteners (M5 x 89), backer plate and outer ring
- 5 tumbler pin with 2 brass keys
- Blank keys available



Spring Latch Sets

LP100

- Includes automatic spring latches, strike plates, 16' cable, and fasteners

LP200 / LP300

- Includes automatic spring latches, strike plates, 16' cable, inside release latch, outside "T" handle with 2 keys, and fasteners
- LP300 includes "T" handle with blind mount

Stock	Description	Box Qty
219000	LP100 Spring Latch Set - Latches and Cable	10
219005	LP200 Spring Latch Set with Handle/Keys	10
219006	LP300 Spring Latch Set with Blind Mount Handle/Keys	10

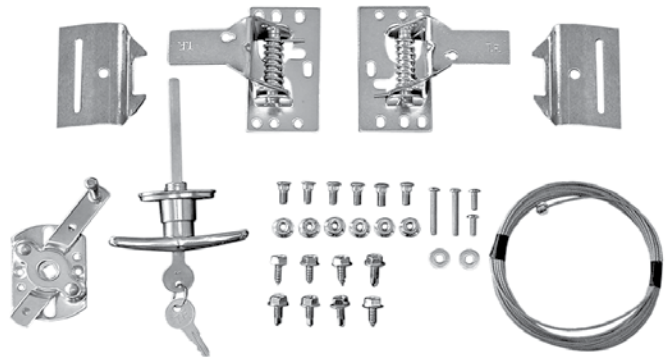

L-Type and T-Type Locking Handle

L-HANDLE

- Keyed randomly
- Outside mount
- Complete with cylinder and 2 keys
- Length of shaft - 4"
- 90° clock wise rotation
- Bright chrome finish
- Blind mount

T-HANDLE

- Keyed randomly
- Outside mount
- Complete with cylinder and 2 keys
- Length of shaft - 3"
- 90° clock wise rotation
- Bright chrome finish
- Conventional or blind mount

Keyed Alike-HANDLE

- Keyed alike by special order only
- Conventional or blind mount
- No specific keys #
- Keyed alike in lots of 20



Stock	Description	Box Qty
214600	T-Type Handle with 2 keys	25
214601	Blank Keys for Locking T & L Handles w/ BM only	
214602	T-Type Handle with 2 keys - Blind Mount	25
214402	L-Type Handle with 2 keys - Blind Mount	20
214600-KA	Keyed Alike T-Type handle with 2 keys	20
214600-KA	Keyed Alike T-Type handle with 2 keys - Blind Mount	20

* Blank Key will only work with T-Type Blind Mount handle

Dummy T-Handle Set

- Complete set
- Includes interior and exterior handle, washers, #10 x 7/8" self tapping screws, push nuts and knurled pin
- 3 1/2" shaft length
- Bright chrome finish

Stock	Description	Box Qty
214680	Dummy T-Handle Set - No Key	25



Automatic Spring Latch Parts

Automatic Spring Latch

- 13 gauge galvanized steel base
- 11 gauge galvanized steel arm

Spring Latch Striker Plate

- Mounts to track for use with spring latch 14 gauge galvanized steel

Push Nuts

- For use on 5/16" square, "T" and "L" handle shafts

Chain and Cable Retainer

- Use to support auto latch chain or cable

Stock	Description	Box Qty
219030	Automatic Spring Latch	25
219040	Spring Latch Strike Plate	50
219050	Push Nuts for Square Handle Shafts - 100 pcs	100
219060	Chain and Cable Retainer - 100 pcs	100

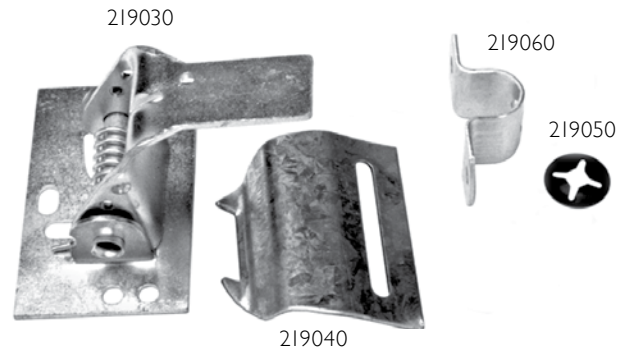

Junior Release Handle

- Steel construction
- Bright zinc plated
- Use with locking "T" or "L" handle to operate auto spring latches

Stock	Description	Box Qty
219021	Junior Inside Release Latch	50



Inside Release Handle

- 11 gauge steel
- Zinc plated
- For use with auto latches and cable

Stock	Description	Box Qty
219020	Inside Release Door Handle, w/Base Mount	50



Lock Bar Disc

- 12 gauge Galvanized Steel

Stock	Description	Box Qty
219100	Lock Bar Disc Plate with Square Hole	50

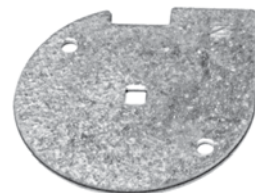

Direct Dial: (817) 834-7300

Lock Bars

- 11/16" wide by 7/32" thick



Stock	Description
219300	Lock Bar for 8' Door - 49 1/2" long
219400	Lock Bar for 9' Door - 55 1/2" long

Lock Bar Guide

- 14 gauge galvanized steel



Stock	Description	Box Qty
219600	Single Lock Bar Guide	50

Lock Bar Disc Spacer

- 14 gauge galvanized steel



Stock	Description	Box Qty
219210	Lock Bar Disc Disc Spacer	25

Lift Handles

Rolled Lift Handle

- Overall length 7"
- Bolt centers 5 1/2"



Drop Lift Handle

- 14 guage galvanized base
- 5/16" zinc plated handle



Stock	Description	Box Qty
219700	Rolled Lift Handle	100
219810	Drop Lift Handle	25

Push Down Bumpers

Push Down Spring Bumper

- 30" overall length
- 12" compression
- Zinc plated steel
- 1" rod diameter
- Sold in pairs

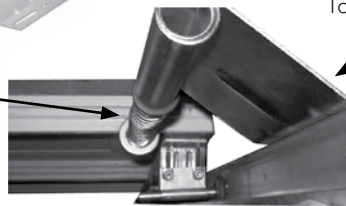
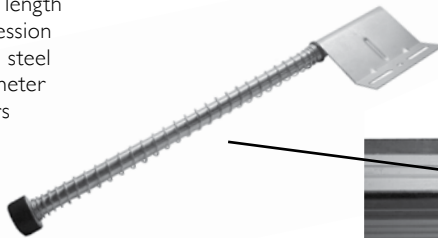

Top (flat) side of the track

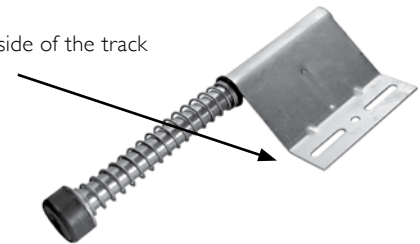

Junior

- 12" overall length
- 5" compression
- Zinc plated steel
- Sold in pairs

The spring must be installed so that nearly all of the compression is achieved with the door in the end of travel in the horizontal track (the door is completely opened). The flat area on the pusher spring bracket is attached to the top side of the track. Note that in this instance only the upper half of the pusher spring contacts the top of the door.

Stock	Description	Box Qty
223201	30" Push Down Spring Bumper	5
223202	12" Junior Push Down Spring Bumper	5

Spring Bumper

Stock	Description	Box Qty
223100	Bumper Spring Bracket Only	48
223190	Safety Bumper Spring with Bracket	8

- Mounts to track to help prevent the door from flying out of the header
- Mounting bracket also available separately
- Sold in pairs



Narrow Body Hinges

- Embossed for added strength

Standart Duty Residential Doors

Stock	Description	Box Qty
222000	#1 18 Gauge - Narrow Body Hinge	50
222100	#2 18 Gauge - Narrow Body Hinge	50
222200	#3 18 Gauge - Narrow Body Hinge	50
222300	#4 18 Gauge - Narrow Body Hinge	50
222400	18 Gauge - Narrow Rail Hinge	50

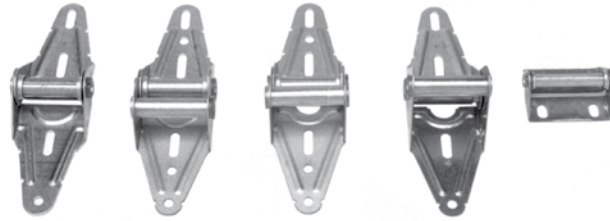

Wide Body Hinges

Commercial Doors

Stock	Description	Box Qty
221901	#1 11 Gauge - Wide Body Hinge	50
221902	#2 11 Gauge - Wide Body Hinge	50
221903	#3 11 Gauge - Wide Body Hinge	50
221904	#4 11 Gauge - Wide Body Hinge	50
221905	#5 11 Gauge - Wide Body Hinge	50
221906	#6 11 Gauge - Wide Body Hinge	25
221907	#7 11 Gauge - Wide Body Hinge	25
221908	#8 11 Gauge - Wide Body Hinge	25
221909	#9 11 Gauge - Wide Body Hinge	25

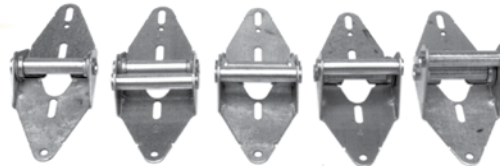

Heavy Residential Doors/ Light Commercial Doors

Stock	Description	Box Qty
221100	#1 14 Gauge - Wide Body Hinge	50
221200	#2 14 Gauge - Wide Body Hinge	50
221300	#3 14 Gauge - Wide Body Hinge	50
221400	#4 14 Gauge - Wide Body Hinge	50
221500	#5 14 Gauge - Wide Body Hinge	50
221600	#6 13 Gauge - Wide Body Hinge	25



Track Rollers

Special application rollers available by special order
All National Door rollers are SOLID shaft

Stock	Description	Box Qty
211900	2" Plastic Residential Track Short Stem Roller	100
212050	2" 10 Ball Nylon Short Stem Roller	100
212060	2" 10 Ball Nylon Long Stem Roller	100
212100	2" 7 Ball Short Stem Track Steel Roller	100
212200	2" 10 Ball Short Stem Track Steel Roller	100
212300	2" 10 Ball Long Stem Track Steel Roller	100
212301	2" 10 Ball Extra Long Stem Track Steel Roller	50
212400	3" 10 Ball Short Stem Track Steel Roller	50
212500	3" 10 Ball Long Stem Track Steel Roller	50
212510	3" 10 Ball Extra Long Stem Track Steel Roller	50

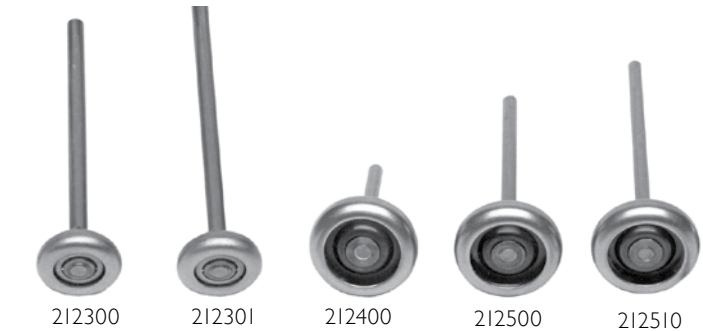

Car Wash Rollers

Stock	Description	Box Qty
212800	2" Short Stem Car Wash Roller - 4" Long Stem	50
212810	2" Long Stem Car Wash Roller - 7 1/4" Long Stem	50
212850	3" Long Stem Car Wash Roller - 7 1/4" Long Stem	25

- Sealed precision bearings
- Plated stems
- 100 lb load rating

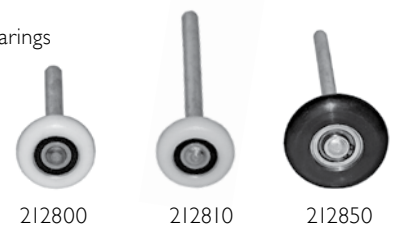

Direct Dial: (817) 834-7300

Cable Safe Device

- Eliminates dislodging lift cables
- Compatible with jackshaft and trolley operators
- Works with vertical lift, high lift, and normal headroom
- 32", 20", 15", 12", and 10" radius track
- Preloaded spring and ready for installation
- Sold in pairs

Cable Safe™



Commercial / Residential Cable Tensioning Device

The Cable Safe™ is a spring driven device that maintains tension on the lifting cables at all times regardless of door position - particularly critical in the fully open position and during object strikes where cable slack is most likely to occur.

Stock	Description	Box Qty
218351	Cable Safe Device	12

Cable Keeper

- Cable tensioning device
- Installs over the roller shaft on the bottom fixture
- Keeps cable properly aligned
- Keeps constant tension on the cable so that the cable doesn't jump off the drum
- A must for doors with chain hoists, operators or full vertical doors
- Sold in pairs

Stock	Description	Box Qty
218350	Cable Keeper - Cable Tensioning Device	10

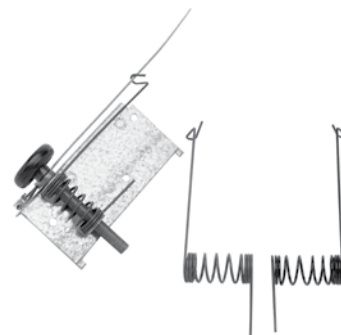

Residential Bottom Brackets

- 13 gauge galvanized steel
- 5 11/16" high x 2 11/16" wide
- 1 1/4" side flange
- Sold in pairs



Stock	Description	Box Qty
218010	2" Bracket with Milford Pin	25

Commercial Bottom Brackets

Stock	Description	Box Qty
218200	2" Commercial Bottom Bracket	5
218300	3" Commercial Bottom Bracket	5

2" and 3" Commercial

- 11 gauge galvanized steel
- 10 7/8" high x 4 5/8" wide
- 1 5/8" side and bottom flange
- Clevis pin included
- Sold by the pair



Stopping Bottom Brackets

- Replaces standard bottom brackets to restrict free fall when one or both cables break
- Sold in pairs

Stock	Description	Box Qty
218322	2" Stopping Bottom Bracket	5
218324	3" Stopping Bottom Bracket	5

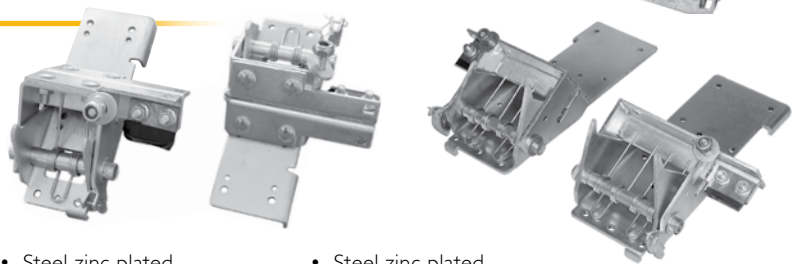

- Steel zinc plated
- 3/16 max cable diameter
- 1,300 lb. max door weight
- Steel zinc plated
- 1/4 max cable diameter
- 1,650 lb. max door weight

Email: sales@natdoor.com



Operator Reinforcing Bracket

- Solid one piece design
- Low cost alternative to 2 piece Adjustable Bracket
- For Residential and Commercial use
- 12 Gauge hot dipped galvanized steel
- Available in 3 sizes 18", 21" and 24"

Stock	Description	Box Qty
221020	18" Operator Reinforcing Bracket	12
221021	21" Operator Reinforcing Bracket	24
221022	24" Operator Reinforcing Bracket	12
221016	18"/21" Narrow Operator Reinforcing Bracket	25
221017	24" Narrow Operator Reinforcing Bracket	25

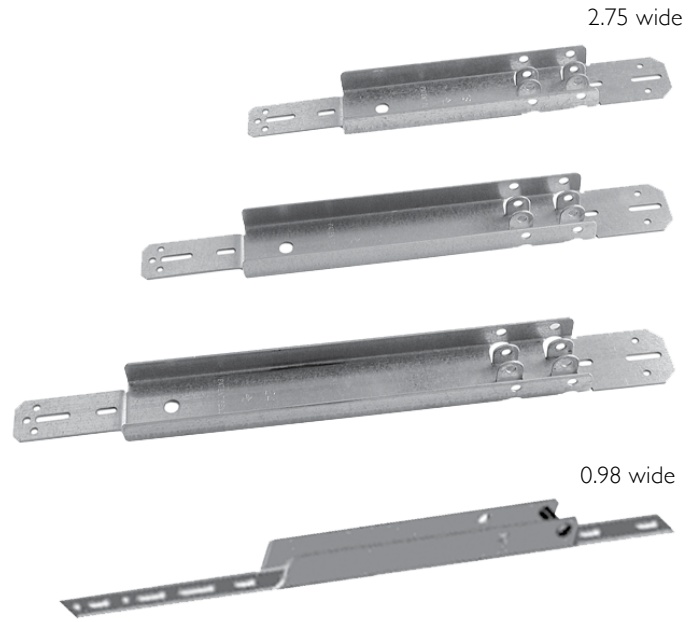

Adjustable Reinforcing Brackets

- Designed to span the top section of doors, for reinforced mounting of operators
- The ARB is adjustable to 18", 19", 21" and 24" section widths
- Top bracket is formed to allow for across the top strut application
- Complete kit includes the top and bottom bracket, fasteners, key, and pin

Stock	Description	Box Qty
221000	Full Hinge Adjustable Reinforcing Bracket	10
221010	Half Hinge Adjustable Reinforcing Bracket	10
221012	Narrow Non-Hinged Adjustable Reinforcing Bracket	12

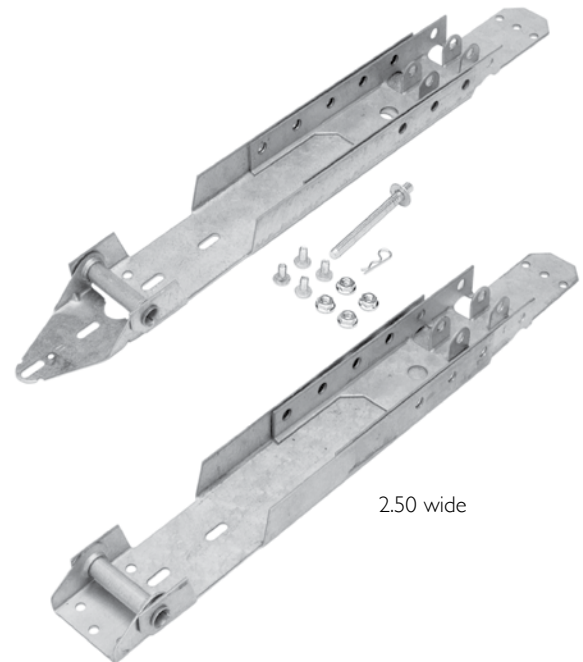

Direct Dial: (817) 834-7300

Low Headroom Kit

The Original O&E Bracket FOR COMMERCIAL OR RESIDENTIAL DOORS Torsion or Stretch Springs

- For torsion or extension spring doors up to 8' high
- Use for light commercial or residential
- Easily installed
- Use standard hardware and track
- Double track not required
- Secure closing of top of door against header
- When installed properly, top of door will not go above spring shaft
- Designed to operate an extension spring door with a minimum of 7" of headroom

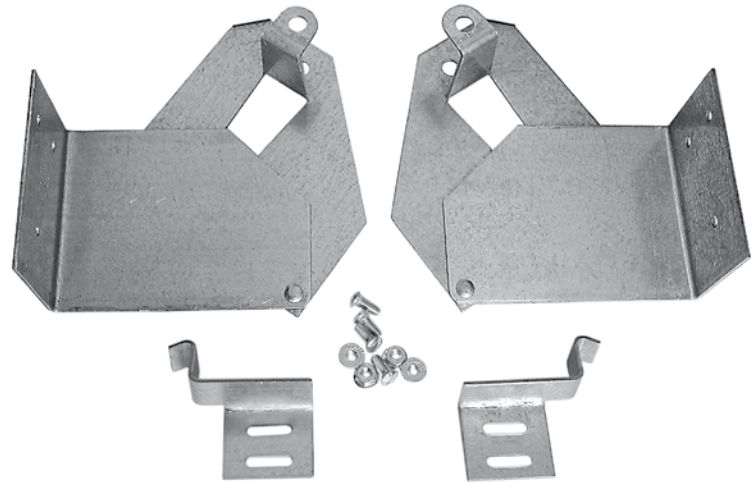
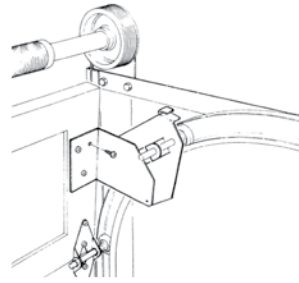

Stock	Description	Box Qty
216000	National Door Low Headroom Kit	10

Quick Closing Top Fixture

- Most common and cost effective solution for low-headroom when installing an automatic garage door opener
- Great for operator installation when you need to get that extra little-bit of headroom
- Rollers may be placed in various bracket hole combinations depending on your specific need
- Replaces the standard top fixture
- Sold as a pair
- Works on both wood or steel doors
- Increases 2" - 4" of space above the open garage door
- Allows for vertical tracks to be cut down to 1 1/2" for more room above the spring for operator installation
- 18 3/16" long x 2 7/8" wide



Stock	Description	Box Qty
216100	Quick Closing Top Fixture (sold by the pair)	12

Jamb Brackets

Stock	Height	Description	Box Qty
220000	2 1/4"	#0 11 Gauge - Jamb Bracket	50
220001	2 3/8"	#1 11 Gauge - Jamb Bracket	50
220002	2 1/2"	#2 11 Gauge - Jamb Bracket	50
220003	2 3/4"	#3 11 Gauge - Jamb Bracket	50
220004	3"	#4 11 Gauge - Jamb Bracket	50
220005	3 1/4"	#5 11 Gauge - Jamb Bracket	50
220006	3 1/2"	#6 11 Gauge - Jamb Bracket	50
220007	3 3/4"	#7 11 Gauge - Jamb Bracket	50
220008	4"	#8 11 Gauge - Jamb Bracket	50
220009	4 1/4"	#9 11 Gauge - Jamb Bracket	50

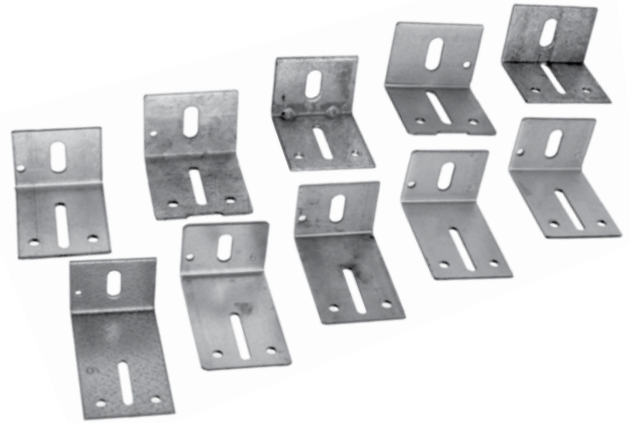

Track Splice Plates

Stock	Description	Box Qty
220011	12 Gauge - Track Splice Plate #1	50
220012	12 Gauge - Track Splice Plate #2	50
220013	12 Gauge - Track Splice Plate #3	50
220014	12 Gauge - Track Splice Plate #4	50
220015	12 Gauge - Track Splice Plate #5	50
220016	12 Gauge - Track Splice Plate #6	50
220017	12 Gauge - Track Splice Plate #7	25
220018	12 Gauge - Track Splice Plate #8	25
219940	12 Gauge - 8" Offset Splice Plate - 7' - 10' Door	25
219950	12 Gauge - 10" Offset Splice Plate - 9' - 12' Door	25
219960	12 Gauge - 12" Offset Splice Plate - 11' - 14' Door	25

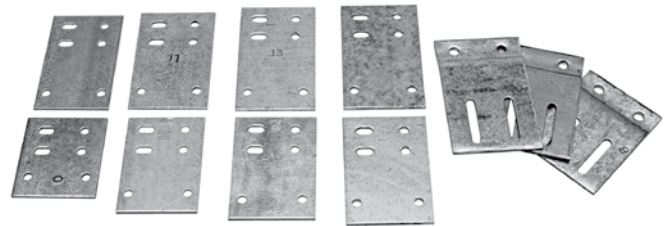

Outside Hookup Bottom Bracket

Reinforced Bottom Bracket with Outside Hookup

- 11 gauge galvanized steel
- 12 gauge galvanized steel reinforcing strap
- 6 7/16" high x 3 1/4" wide
- Clevis pin included
- Sold in pairs

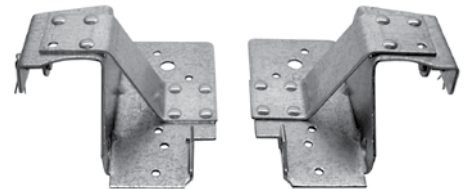

Stock	Description	Box Qty
218310	Bracket Reinforced with Outside Hookup	10

Commercial Top Bracket

- Steel
- Slide is 13 gauge galvanized steel
- Adjustable 7/16" to 1 13/16" and 1 7/8" to 3 7/8"
- For 2" or 3" track



Stock	Description	Box Qty
217800	Commercial Top Bracket	25

Residential Top Bracket

- 16 gauge galvanized bracket
- 14 gauge galvanized slide
- Adjustable 3/8" to 7/8" and 1 7/8" to 3 3/16"
- 2 fastener adjustments

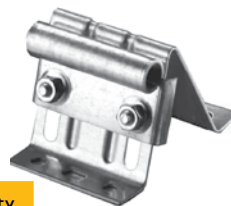

Stock	Description	Box Qty
217700	Residential Top Bracket	25

Steel Door Commercial Top Bracket

- Commercial top bracket for steel doors
- 12 gauge galvanized steel bracket
- 13 gauge galvanized steel slide
- Adjustable 9/16" to 4 1/2"
- For 2" or 3" track



Stock	Description	Box Qty
217900	Commercial Top Bracket for Steel Doors	25

Direct Dial: (817) 834-7300

Low Headroom Top Bracket

- Replacement top bracket for low headroom installations



Stock	Description	Qty
217710	Low Headroom Top Bracket	25

Pull Rope

Stock	Description
167700	3/8" x 500' Polyester Pull Rope
167701	#10 x 5/16" x 100' Cotton Sash Cord
167702	#12 x 3/8" x 100' Cotton Sash Cord

Load capacity in LBS		
3/8"	Polyester Pull Rope	270 lb
5/16"	Cotton Sash Cord	1000 lb
3/8"	Cotton Sash Cord	1290 lb

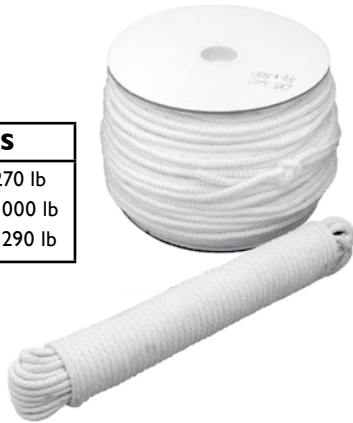

S - Hooks

Stock	Description
222500	1/8" x 1 1/8" S-Hooks for Latch Chain - 100 pcs
222510	1/4" x 2 1/4" S-Hooks - 100 pcs



Latch Chain

- #8 sash chain
- .035" thick
- 75 lbs working load limit
- 300 lbs break strength

Stock	Description
216901	#8 x 100' Latch Chain
216902	#8 x 250' Latch Chain

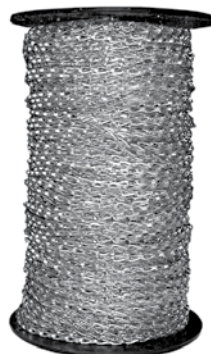

Spring Anchor Brackets

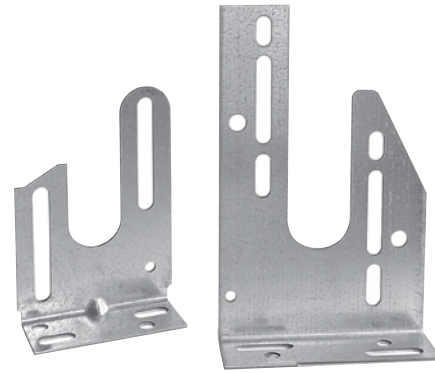

Stock	Description	Box Qty
232110	12 gauge Mini-Resi Spring Anchor Bracket	50
232000	8 gauge Universal Spring Anchor Bracket - Right	25
232100	11 gauge Universal Spring Anchor Bracket - Right	25
232001	8 gauge Universal Spring Anchor Bracket - Left	25
232101	11 gauge Universal Spring Anchor Bracket - Left	25

Eye Bolts

Stock	Description
222511	Eye Bolt 5/16" x 3 3/4" - 100 pcs



Cotter Keys

- Cotter key for the Clevis Pins above are 3/16" diameter and 1 1/8" overall length



Stock	Description
223001	Cotter Keys - 100 pcs

Clevis Pins

- Clevis Pins are 5/16" in diameter and 1 1/32" in overall length



Stock	Description	Box Qty
223000	Clevis Pin	100

Sheaves

Stock	Description	Box Qty
213000	3" Sheave Only	50
213100	4" Sheave Only	25
213300	3" Sheave with Stud	50
213400	4" Sheave with Stud	25
213500	5" Sheave with Stud	25
213600	3" Sheave with Clevis	50
213700	4" Sheave with Clevis	25
213800	5" Sheave with Clevis	15



Shaft Bearings

Stock	Description	Box Qty
222600	Shaft Bearing - 1" Inside Diameter	50
222605	Nylon Shaft Bearing - 1" Inside Diameter	50
222610	Shaft Bearing - 1 1/4" Inside Diameter	50
222700	Bearing Retainer Plate - 1" Only	50



Flat End Bearing Supports

- Shaft support bracket
- Fits 1" shaft

Stock	Description	Box Qty
220020	# 1 Flat End Bearing Support - 3 3/8" Center	25
220021	# 2 Flat End Bearing Support - 4 3/8" Center	25
220022	# 3 Flat End Bearing Support - 5" Center	25
220023	# 4 Flat End Bearing Support - 6" Center	25

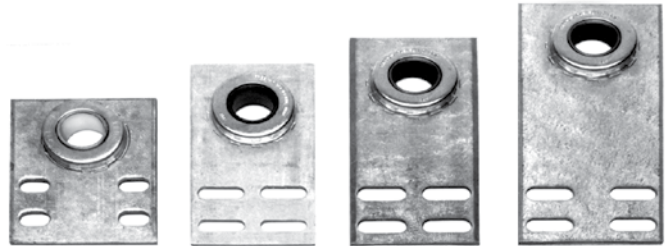

Flanged End Bearing Supports

- Shaft support bracket
- Sold in pairs
- Fits 1" shaft

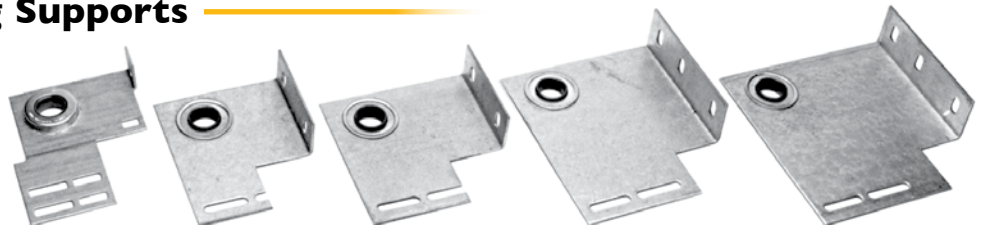

Stock	Description	Box Qty
220035	Residential Flanged End Bearing Support - 3 3/8" Center	6
220030	Flanged End Bearing Support - 3 3/8" Center	6
220031	Flanged End Bearing Support - 4 3/8" Center	6
220032	Flanged End Bearing Support - 5" Center	6
220033	Flanged End Bearing Support - 6" Center	6

Direct Dial: (817) 834-7300

Center Supports

- Shaft support bracket
- Also known as spring pads
- Fits 1" shaft

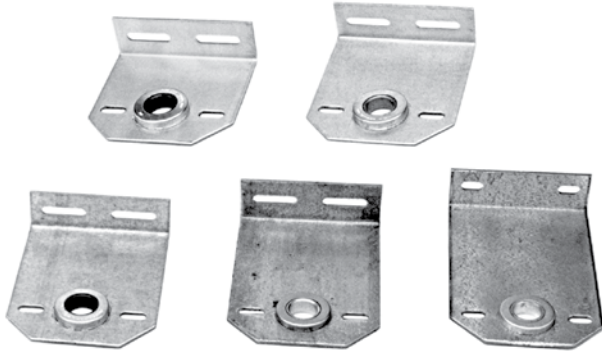

Stock	Description	Box Qty
220025	Center Support - 3 3/8" Center	25
220026	Center Support - 4 3/8" Center	25
220027	Center Support - 5" Center	25
220028	Center Support - 6" Center	25
220029	Center Support - 7" Center	25

Step Plates

- 12 gauge galvanized steel



Stock	Description	Box Qty
219900	Step Plate	25

Punched Angle Iron

Stock	Description	Box Qty
200000-08	1" x 1 1/2" x 8' 16 Gauge Punched Angle	50
200001-08	1" x 1 1/2" x 8' 14 Gauge Punched Angle	50
200002-08	1 1/4" x 1 1/4" x 8' 16 Gauge Punched Angle	50
200003-08	1 1/4" x 1 1/4" x 8' 14 Gauge Punched Angle	50
200004-08	1 1/2" x 1 1/2" x 8' 13 Gauge Punched Angle	25
200005-08	2" x 2" x 8' 12 Gauge Punched Angle	25
200050-08	1" x 1 1/2" x 8' 16 Gauge Punched Angle - mini bundle	10
200051-08	1" x 1 1/2" x 8' 14 Gauge Punched Angle - mini bundle	10
200052-08	1 1/4" x 1 1/4" x 8' 16 Gauge Punched Angle - mini bundle	10
200053-08	1 1/4" x 1 1/4" x 8' 14 Gauge Punched Angle - mini bundle	10
200054-08	1 1/2" x 1 1/2" x 8' 13 Gauge Punched Angle - mini bundle	5
200055-08	2" x 2" x 8' 12 Gauge Punched Angle - mini bundle	5

Track Sections

- Track sold in pairs

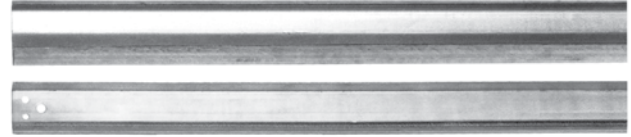

Stock	Description
218400	2" Straight Track - 10' long 14 gauge
218410	2" Straight Track - 14' long 14 gauge
218500	3" Straight Track - 14' long 12 gauge

Flag Bracket

- Slotted flag bracket for door thicknesses from 3/4" to 2 1/8", at 7" high
- Sold in pairs



Stock	Description	Box Qty
218360	Flag Bracket	10



- Quality galvanized steel
- 11/32" diameter holes on 1" centers
- 16, 14, 13, and 12 gauge material to suit your installation requirements
- Available in mini bundles
- Easy to recognize color coded gauges
 - Blue - 16 gauge
 - Green - 14 gauge
 - Red - 13 gauge
 - Yellow - 12 gauge

Reduced Drive Chain Hoist

- Wall mounted
- 4 to 1 Reduced Drive
- Includes sprocket, 3' roller chain, 26' hand chain, chain keeper, 1/4" key
- Individually boxed, shipping weight 24 lbs.
- Chromate zinc coated frame
- 36 tooth sprocket
- 41" chain
- 1" or 1 1/4" shaft

Stock	Description
217300	Reduced Drive Chain Hoist 4 to 1 ratio - 1" Shaft
217305	Reduced Drive Chain Hoist 4 to 1 ratio - 1 1/4" Shaft

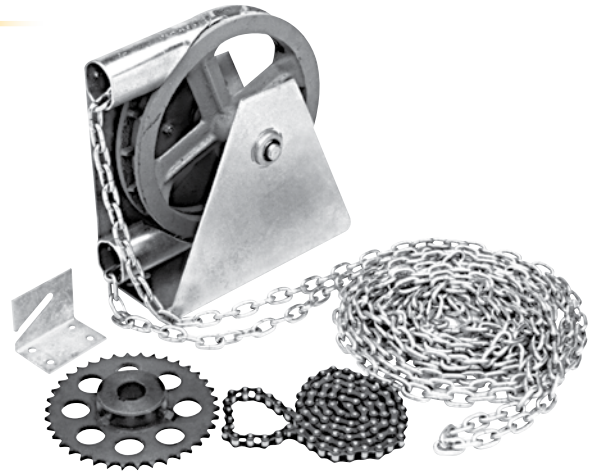

Direct Drive Chain Hoist

- Fits 5 3/8" minimum offset
- Direct drive for 1" shaft
- Mounts to torsion shaft
- Includes 26' hand chain, chain keeper, 2 shaft collars, 1/4" key
- Chromate zinc coated frame
- Individually boxed, shipping weight 15 lbs.

Stock	Description
217200	Direct Drive Chain Hoist 5 3/8" offset



Reduced Drive Chain Hoist JR

- Jack shaft mounting
- 4 to 1 reduced drive
- Includes sprocket, 22" roller chain, 26' hand chain, 2 shaft collars, chain keeper, wall bracket, 1/4" key
- Individually boxed, shipping weight 19 lbs.

Stock	Description
217320	Reduced Drive Chain Hoist 4 to 1 ratio - 1" Shaft

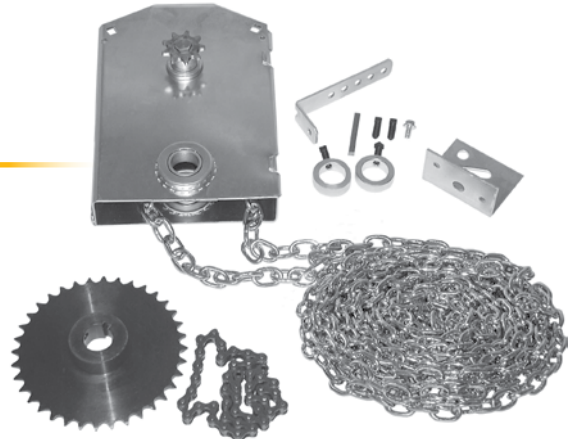

Reduced Drive Chain Hoist RD-200

- Wall mounting
- 3 to 1 reduced drive
- Includes sprocket, 3' roller chain, 26' hand chain, chain keeper, 1/4" key
- Individually boxed, shipping weight 22 lbs.

Stock	Description
217310	Reduced Drive Chain Hoist 3 to 1 ratio - 1" Shaft

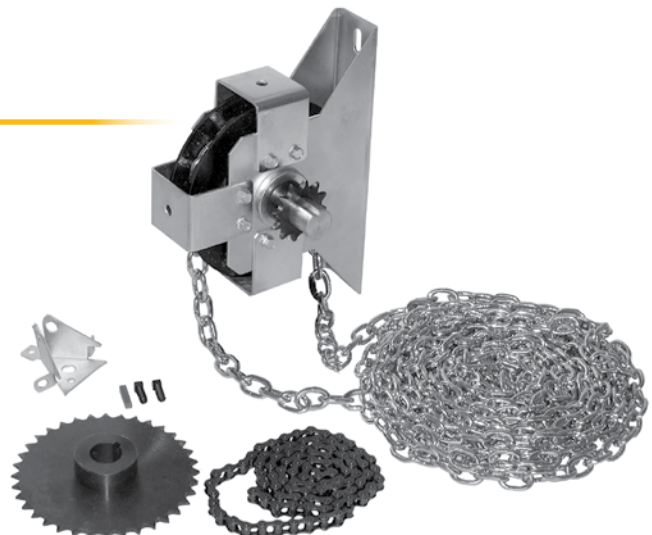

Direct Dial: (817) 834-7300

Rolling Door Reduced Drive Chain Hoist **SRD-2000R**

- Wall mounting for sheet rolling doors with dead axle
- 4 to 1 reduced drive
- Includes sprocket to bolt to curtain drum 4.5" bolt circle, 46" roller chain, 26' hand chain, chain keeper, 1/4" key
- Individually boxed, shipping weight 19 lbs.

Stock	Description
217325	Rolling Door Reduced Drive Chain Hoist - 4 to 1 ratio - 1" Shaft

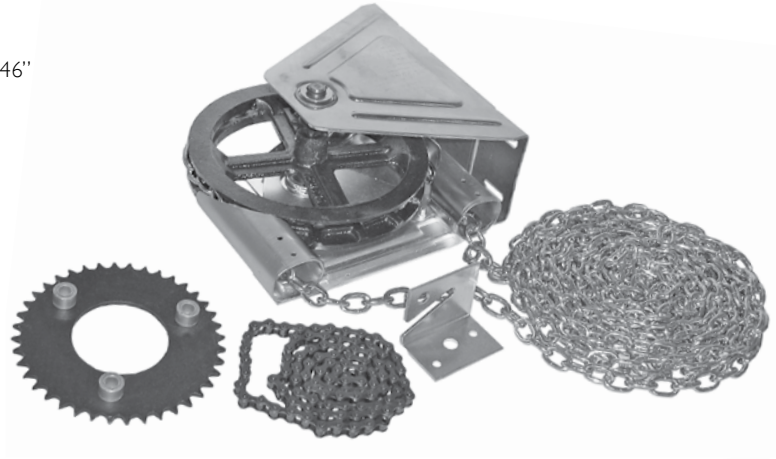

Direct Drive Chain Hoist **DD-200**

- Fits 3 3/8" minimum offset
- Direct drive for 1" shaft
- Includes 26' hand chain, chain keeper, 2 shaft collars, 1/4" key
- Individually boxed, shipping weight 15 lbs.

Stock	Description
217210	Direct Drive Chain Hoist



Chain Hoist Sprockets

- Replacement sprocket for reduced drive hoists
- 1" or 1 1/4" 36 tooth sprocket #41 chain
- 1" or 1 1/4" 60 tooth sprocket #41 chain
- 1/4" keyway

Stock	Description
217330	Hand Chain for Chain Hoist - 26'
217331	1" - 36 Tooth Sprocket #41 Chain
217335	1 1/4" - 36 Tooth Sprocket #41 Chain
217332	1" - 60 Tooth Sprocket #41 Chain
217336	1 1/4" - 60 Tooth Sprocket #41 Chain

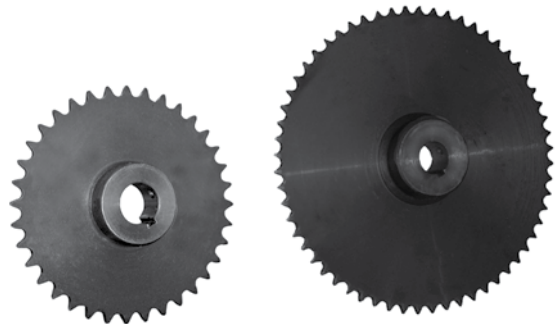

Chain Hoist Tensioner

- Keeps chain aligned with chain hoist
- Easy to install
- Protective cover for more security
- Fits most types of hand chain or hoist
- Sold by each

Stock	Description
217339	Chain Hoist Tensioner

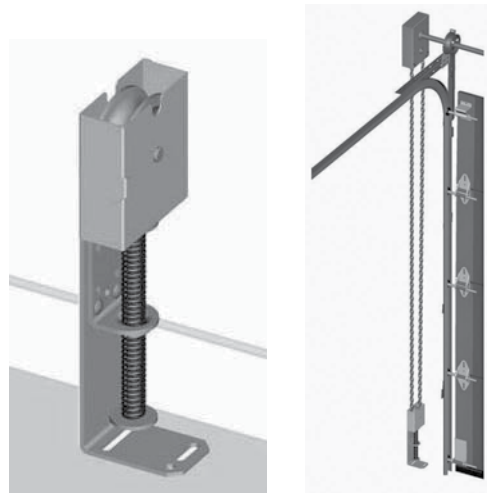

Chain Keepers

Stock	Description	Box Qty
217337	Chain Keeper - Stamped	50
217338	Chain Keeper - Cast	25

Stamped

- 2 bolt holes
- Zinc plated
- Padlock hole

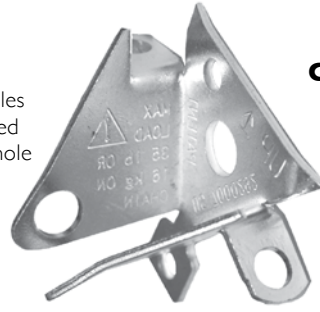

Cast

- 2 bolt holes
- Painted grey

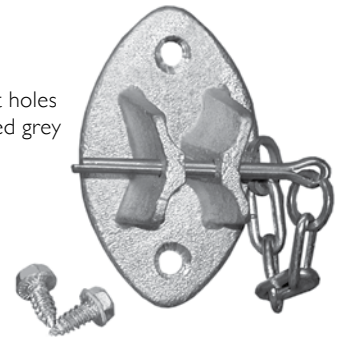

Spreader Bar Set

- Zinc plated steel
- 2 spreader bars
- Fastener Bag includes bolts, nuts, washers, lock washers and shaft collars

Stock	Description	Box Qty
217100	Commercial Spreader Bar Set	15

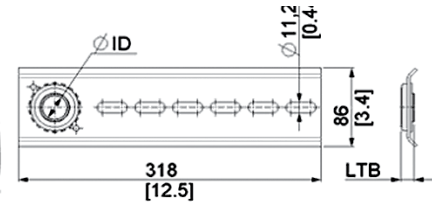
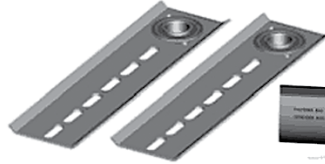

Roller Chain

- Five ANSI sizes available
- For use with standard sprockets
- Factory pre-lubricated, positive pitch control for exceptionally long service life
- Meets all American National Standards Institute (ANSI) requirements

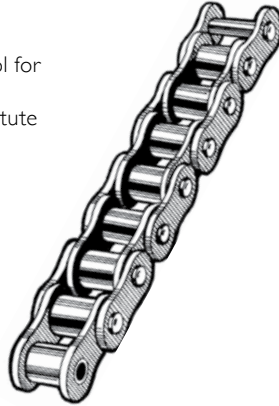

Stock	Description
217340	#35 Roller Chain - 10' length
217341	#40 Roller Chain - 10' length
217342	#41 Roller Chain - 10' length
217343	#50 Roller Chain - 10' length
217344	#60 Roller Chain - 10' length

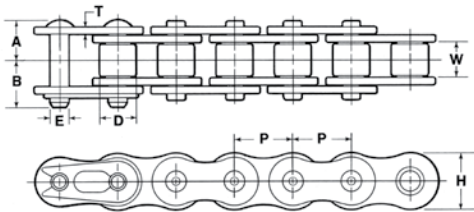

Specifications

National Door Roller Chain is designed and carefully made to meet all ANSI standards for transmitting power on motor drives. Special lubricating methods and programmed preloading insures minimum break-in wear, and extends useful service life. Copper-plated end pins make chain easy to take apart for repairs. Fully inter-changeable with other ANSI roller chain.

ANSI Size	DIMENSIONS IN INCHES							Ultimate Str.	Avg.Wt. per ft.
	Pitch	Roller Width	Roller Dia.	Rivet End to End to	Conn. End to End to	Pin Dia.	(lbs.)		
35	3/8	3/16	.200	.228	.276	.141	2400	.22	
40	1/2	5/16	.312	.319	.358	.156	4000	.41	
41	1/2	1/4	.306	.260	.307	.141	2700	.27	
50	5/8	3/8	.400	.394	.453	.200	6600	.68	
60	3/4	1/2	.469	.492	.547	.234	9200	.95	

Offset Links (1/2 Links)

- Used to assemble chain strands with an odd number of pitches
- 10 pieces per package



Stock	Description
217360	Offset Half Link for #35 Chain
217361	Offset Half Link for #40 Chain
217362	Offset Half Link for #41 Chain
217363	Offset Half Link for #50 Chain
217364	Offset Half Link for #60 Chain

Master Links

- Used to assemble chain strands with an even number of pitches
- 10 pieces per package

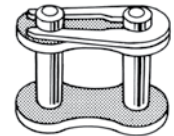

Stock	Description
217350	Connecting (Master) Link for #35 Chain
217351	Connecting (Master) Link for #40 Chain
217352	Connecting (Master) Link for #41 Chain
217353	Connecting (Master) Link for #50 Chain
217354	Connecting (Master) Link for #60 Chain

Roller Links

- Used for replacement of damaged rollers or to lengthen chain
- 10 pieces per package

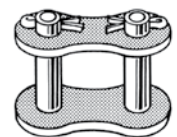

Stock	Description
217370	Roller Link for #35 Chain
217371	Roller Link for #40 Chain
217372	Roller Link for #41 Chain
217373	Roller Link for #50 Chain
217374	Roller Link for #60 Chain

Direct Dial: (817) 834-7300

WHITING Truck Door Parts

Bottom Roller Cover



Stock	Description	Box Qty
233101	WHITING Bottom Roller Cover	25

Center Hinge

- 2" wide
- 6 1/4" long



Stock	Description	Box Qty
233102	WHITING Center Hinge	25

Adjustable Top Fixture

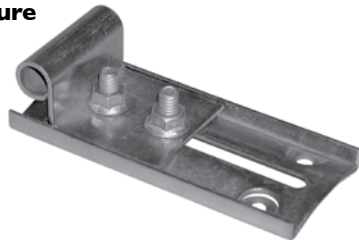

Stock	Description	Box Qty
233104	WHITING Adjustable Top Fixture Complete	25

Security Lock

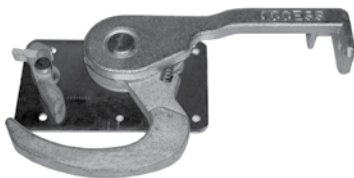

Stock	Description
233000	TODCO Maximum Security Lock

Bottom Stud Plate

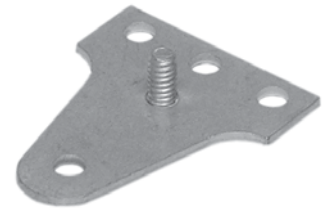

Stock	Description	Box Qty
233100	WHITING Bottom Stud Plate	25

End Hinge



Stock	Description	Box Qty
233103	WHITING End Hinge	25

1" Truck Door Rollers

- Zinc galvanized finish stem and steel tire
- 1" overhead truck and trailer door tracks



Stock	Description
212679	1" Economy Truck Door Rollers

Step Bolts

- Step bolts may be used in place of rive for fastening truck door hardware
- 10 per package



Stock	Description
233010	TODCO Step Bolt - 1/4" x 1 1/4"

Additional WHITING Truck Door parts available. Contact Customer Service.

Email: sales@natdoor.com



TODCO Truck Door Parts

Bottom Fixture



Stock	Description	Box Qty
233001	TODCO Bottom Fixture	25

Top Fixture



Stock	Description	Box Qty
233004	TODCO Adjustable Top Fixture Assembly	25

Hinges

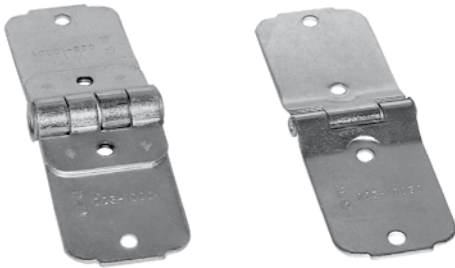

Stock	Description	Box Qty
233002	TODCO End Hinge	25
233003	TODCO Center Hinge	25

Cable Brackets



Stock	Description	Box Qty
233009	TODCO Cable Anchor Bracket	25

Bearing Assembly



Stock	Description	Box Qty
233005	TODCO Bearing Assembly	25

Cable Drums - Truck Doors



Stock	Description
233006	TODCO Cable Drum - Left hand
233007	TODCO Cable Drum - Right Hand

Head Seal Assembly

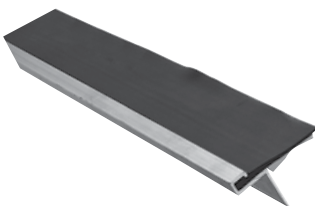

Stock	Description
233015	TODCO 96" Head Seal Assembly

Side Seal



Stock	Description
233008	TODCO Side Seals - Pair

Direct Dial: (817) 834-7300

TODCO Style Door Panels

Full Truck Door with springs and hardware assembly available by special order.
Please contact sales department for pricing availability.

Intermediate Panels/Bottom Panels

- T-Style
- These panels are cut to an extra wide width to fit wider vehicle applications
- Interlocking tongue and groove design for weather-tight joint and proper panel alignment
- 3/4" thick, 7 ply, exterior grade,
- Wood panels - grey in color
- Paintable
- Factory Direct: LTL only

Stock	Description
233022	TODCO Style Intermediate Panel - 15" x 98"
233024	TODCO Style Intermediate Panel - 11" x 98"
233021	TODCO Style Bottom Panel - 15" x 98"
233023	TODCO Style Bottom Panel - 11" x 98"

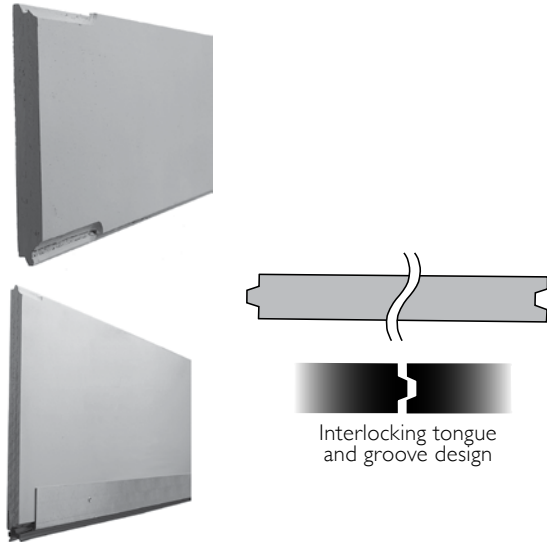

Factory direct shipments only

Spring Cone Sets

Sold in pairs only

Stock	Description	Box Qty
231000	1 3/4" Spring Cone Set	25
231100	2" Spring Cone Set	25
231200	2 5/8" Spring Cone Set	20

1-3/4"

2"

2 5/8"



Stock	Description
Universal thread sold in pairs	
231301	3 3/4" Spring Cone Set
231401	5 1/4" Spring Cone Set
231501	6" Spring Cone Set



Sold in sets only

Stock	Description
Non universal thread sold in sets only - 4 pieces	
231300	3 3/4" Spring Cone Set - 2 pair

3 3/4"

5 1/4"

6"



Extension Springs

- 5" x 42" springs for 7' high doors
- Other lengths by special order
- 25" in length, relaxed
- 42" of stretch
- 67" overall length when stretched
- Double loop ends
- From 50 lbs to 180 lbs of pull
- Heavier gauge springs for heavier weight doors



Double Loop Ends



Description		DASMA Color Code	Stock	Description
50#	Extension Spring	Red	232920	50# 25" x 42" Extension Spring
60#	Extension Spring	Brown	232921	60# 25" x 42" Extension Spring
70#	Extension Spring	Orange	232922	70# 25" x 42" Extension Spring
80#	Extension Spring	Gold	232923	80# 25" x 42" Extension Spring
90#	Extension Spring	Lt. Blue	232924	90# 25" x 42" Extension Spring
100#	Extension Spring	Tan	232925	100# 25" x 42" Extension Spring
110#	Extension Spring	White	232926	110# 25" x 42" Extension Spring
120#	Extension Spring	Green	232927	120# 25" x 42" Extension Spring
130#	Extension Spring	Yellow	232928	130# 25" x 42" Extension Spring
140#	Extension Spring	Blue	232929	140# 25" x 42" Extension Spring
150#	Extension Spring	Red	232930	150# 25" x 42" Extension Spring
160#	Extension Spring	Brown	232931	160# 25" x 42" Extension Spring
170#	Extension Spring	Orange	232932	170# 25" x 42" Extension Spring
180#	Extension Spring	Gold	232933	180# 25" x 42" Extension Spring

One-Piece Door Springs

Jamb Type Springs

P328

- 28" overall length, 2" O.D.
- #3 Wire Gauge (.244)
- 18 1/2" maximum stretch
- 165-185 lbs. initial tension



P528

- 28" overall length, 1 5/8" O.D.
- #5 Wire Gauge (.207)
- 22" maximum stretch
- 135-145 lbs. initial tension



P728

- 28" overall length, 1 5/16" O.D.
- #7 Wire Gauge (.177)
- 18 1/2" maximum stretch
- 110-120 lbs. initial tension

P928

- 28" overall length, 1 1/4" O.D.
- #9 Wire Gauge (.148)
- 18 1/2" maximum stretch
- 45-55 lbs. initial tension

Weight Chart for E900 Hardware Sets

Door Weight (lbs.)	# of Springs	Spring Type
Up to 75	2	P928C
90 to 150	2	P728C
105 to 175	2	P528C
125 to 250	2	P328C
150 to 300	4	P728C
200 to 350	4	P528C

One piece door springs include containments

Stock	Description
225516	P328 Extension Spring for 1 Piece Jamb Type Door
225517	P528 Extension Spring for 1 Piece Jamb Type Door
225518	P728 Extension Spring for 1 Piece Jamb Type Door
225519	P928 Extension Spring for 1 Piece Jamb Type Door

Direct Dial: (817) 834-7300

Torsion Springs with Cones

- National carries the most commonly used torsion spring sizes to handle most customer needs
- All springs are treated with heat applied paint, stensiled with wire size, length size, color coded and coned
- Use 600 Molilube to give new life to rusty springs
- Install left wound springs on the right hand for standard lift — Inside Looking Out
- Install right wound springs on the left hand for standard lift — Inside Looking Out
- Special sizes and lengths available by special order

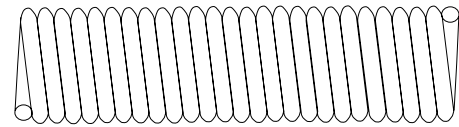

RW

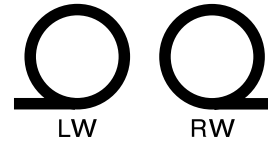

LW

RW

Stock	Size	Color	Wound / Coned
2420A0	207 x 2 x 20	Yellow	Left Wound
2420A1	207 x 2 x 20	Yellow	Right Wound
2420C0	207 x 2 x 22	Yellow	Left Wound
2420C1	207 x 2 x 22	Yellow	Right Wound
2420D0	207 x 2 x 23.5	Yellow	Left Wound
2420D1	207 x 2 x 23.5	Yellow	Right Wound
2420F0	207 x 2 x 25.5	Yellow	Left Wound
2420F1	207 x 2 x 25.5	Yellow	Right Wound
2421D0	218 x 2 x 23.5	White	Left Wound
2421D1	218 x 2 x 23.5	White	Right Wound
2421G0	218 x 2 x 26	White	Left Wound
2421G1	218 x 2 x 26	White	Right Wound
2421K0	218 x 2 x 30	White	Left Wound
2421K1	218 x 2 x 30	White	Right Wound
2422E0	225 x 2 x 24	Red	Left Wound
2422E1	225 x 2 x 24	Red	Right Wound
2422H0	225 x 2 x 27	Red	Left Wound
2422H1	225 x 2 x 27	Red	Right Wound
2423G0	234 x 2 x 26	Brown	Left Wound
2423G1	234 x 2 x 26	Brown	Right Wound
2423J0	234 x 2 x 29	Brown	Left Wound
2423J1	234 x 2 x 29	Brown	Right Wound
2424J0	243 x 2 x 29	Green	Left Wound
2424J1	243 x 2 x 29	Green	Right Wound
2424L0	243 x 2 x 31	Green	Left Wound
2424L1	243 x 2 x 31	Green	Right Wound
2424N0	243 x 2 x 33	Green	Left Wound
2424N1	243 x 2 x 33	Green	Right Wound
2425J0	250 x 2 x 29	Gold	Left Wound
2425J1	250 x 2 x 29	Gold	Right Wound
2425P0	250 x 2 x 34	Gold	Left Wound
2425P1	250 x 2 x 34	Gold	Right Wound
2426K0	262 x 2 x 30	Blue	Left Wound
2426K1	262 x 2 x 30	Blue	Right Wound
2426Q0	262 x 2 x 35	Blue	Left Wound
2426Q1	262 x 2 x 35	Blue	Right Wound
2426U0	262 x 2 x 39	Blue	Left Wound
2426U1	262 x 2 x 39	Blue	Right Wound



Cable Drums

400-8

Standard Lift - Residential

- Residential drum, for use on 1" tubular shaft only, maximum wall 13 ga. (.093")
- Maximum door height 8' 1"
- 1/8" maximum cable diameter
- 530 lbs. maximum door weight (265 lbs. per drum)
- Set screws
- Sold in pairs



Stock	Description	Box Qty
231600	Standard Lift Residential Drums	12

400-12

Standard Lift

- Light Duty Commercial
- Commercial drum, for use on either tubular shaft or 1" solid keyed shaft
- Maximum door height 12' 1"
- 5/32" maximum cable diameter
- 550 lbs. maximum door weight (375 lbs. per drum)
- Set screws
- Sold in pairs

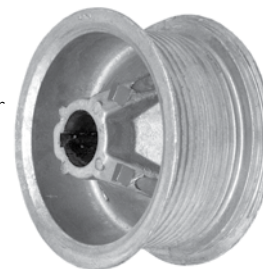

Stock	Description	Box Qty
231610	400-12 Standard Lift Commercial Drums	6

5250-18

Standard Lift

- Medium Duty Commercial
- Commercial drum, for use on 1" solid keyed shaft, or tubular shaft if desired
- Maximum door height 18' 1"
- 3/16" maximum cable diameter
- 1,500 lbs. maximum door weight (750 lbs. per drum)
- Set screws
- Sold in pairs

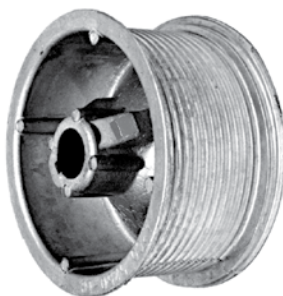

Stock	Description	Box Qty
231630	5250-18 Standard Lift Commercial Drums	3

800-32

Standard Lift

- Heavy Duty Commercial
- Commercial drum, for use on 1" solid keyed shaft
- Maximum door height 32' 1"
- 1/4" maximum cable diameter
- 2,000 lbs. maximum door weight (1,000 lbs. per drum)
- Set screws
- Also available for 1 1/4" shaft
- Sold in pairs



Stock	Description	Box Qty
231640	800-32 Heavy Duty Standard Lift Commercial Drums	1

400-54

Hi-Lift

- Light Duty Commercial
- Light Duty Hi-Lift Commercial drum, 1" solid keyed shaft, or 13 ga. tubular shaft
- Maximum door height equals 120" plus hi-lift
- 1/8" maximum cable diameter
- 550 lbs. maximum door weight (275 lbs. per drum)
- Set screws
- Sold in pairs



Stock	Description	Box Qty
231650	400-54 Light Duty Hi-Lift Commercial Drums	6

5250-54

Hi-Lift

- Medium Duty Commercial
- Medium Duty Hi-Lift Commercial drum, 1" solid keyed shaft, or 13 ga. tubular shaft
- Maximum door height 180" plus hi-lift
- 3/16" maximum cable diameter
- 1,000 lbs. maximum door weight (500 lbs. per drum)
- Set screws
- Also available for 1 1/4" shaft
- Sold in pairs



Stock	Description	Box Qty
231660	5250-54 Hi-Lift Commercial Drums	2

Note: 1-1/4" shaft and cable drums available by special order.
Contact Customer Service
(817) 834-7300

Direct Dial: (817) 834-7300

5750-120

Hi-Lift

- Medium duty commercial
- Medium duty hi-lift commercial drum, 1" solid keyed shaft, or 13 ga. tubular shaft
- 3/16" maximum cable diameter
- Maximum door height equals 144" plus hi-lift
- 1,000 lbs. maximum door weight (500 lbs. per drum)
- Set screws
- Also available for 1 1/4" shaft
- Sold in pairs



6375-164

Hi-Lift

- Heavy duty commercial
- Light duty hi-lift commercial drum, for use on 1" solid keyed shaft
- Maximum door height equals 229" plus hi-lift
- 1/4" maximum cable diameter
- 1,600 lbs. maximum door weight (1,000 lbs. per drum)
- Set screws
- Also available for 1 1/4" shaft
- Sold in pairs



Stock	Description	Box Qty
231670	5750-120 Hi-Lift Commercial Drums	2

Stock	Description	Box Qty
231680	6375-164 Heavy Duty Hi-Lift Commercial Drums	1

850-11

Vertical-Lift

- Light duty commercial
- Light duty vertical-lift commercial drum, 1" solid keyed shaft, or tubular shaft
- Maximum door height equals 11' 1"
- 3/16" maximum cable diameter
- 850 lbs. maximum door weight (425 lbs. per drum)
- Set screws
- Also available for 1 1/4" shaft
- Sold in pairs



1100-18

Vertical-Lift

- Medium duty commercial
- Medium duty vertical-lift commercial drum, 1" solid keyed shaft, or tubular shaft
- Maximum door height equals 18' 1"
- 3/16" maximum cable diameter
- 1320 lbs. maximum door weight (660 lbs. per drum)
- Set screws
- Also available for 1 1/4" shaft
- Sold in pairs



Stock	Description	Box Qty
231690	850-11 Vertical-Lift Commercial Drums	2

Stock	Description	Box Qty
231700	1100-18 Vertical-Lift Commercial Drums	2

Drum Conversion Chart

Cross Reference Chart
DNS / APCO / Canimex / OMI

STANDARD LIFT DRUMS			
DNS	APCO	Canimex	OMI
4X-8	400-8	D400-96	2000
4-12M	400-12	D400-156	2100
402-32	800-32	-	2300
5	-	-	-
5-18	5250-18	D525-216	2200
6	-	-	-

Cross Reference Chart
DNS / APCO / Canimex / OMI

HIGH LIFT DRUMS			
DNS	APCO	Canimex	OMI
54	5250-54	D525-54	2500
54LC	400-54	D400-54	2400
120	5750-120	D575-120	2700
410-164	6375-164	-	2800

Cross Reference Chart
DNS / APCO / Canimex / OMI

VERTICAL LIFT DRUMS			
DNS	APCO	Canimex	OMI
143-11	850-11	D850-132	2900
263-18	1100-18	D1100-216	2902

**Note: 1-1/4" shaft and cable drums available by special order.
Contact Customer Service
(817) 834-7300**

Tube Coupling

- Recommended for residential doors only
- Non adjustable
- Low carbon steel
- Black coating finish
- Complete with 4 set screws
- No keyway
- 2 1/2" long



Stock	Description	Box Qty
230120	Tube Coupling - 1"	10

Solid Couplings

- Non adjustable
- Low carbon steel
- Zinc plated
- Complete with 3 set screws for 1" coupling, 4 set screws for 1 1/4" coupling
- 1/4" keyway
- 4 3/4" long



Stock	Description	Box Qty
230110	Solid Coupling - 1"	20
230210	Solid Coupling - 1 1/4"	20

Square Keys & Stock

- Zinc plated
- Made in USA



Stock	Description
231880	1/4" Key Stock - 12" length - 6/pkg
231885	1/4" Bent Shaft Key - 3" length - 12 /pkg

Adjustable Shaft Couplers

- Cast iron couplers
- Two sizes, 1" and 1 1/4"
- Comes with 1/4" keyway, serrated washer, hex bolt, and nylon flanged nut

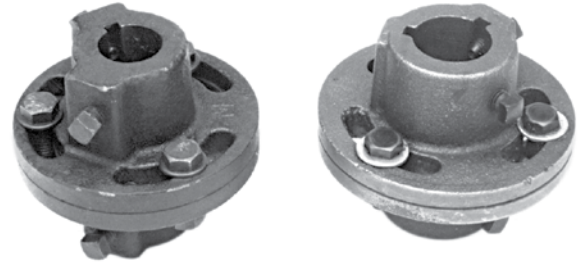

Stock	Description	Box Qty
230100	1" Adjustable Shaft Coupling -Cast Iron	10
230200	1-1/4" Adjustable Shaft Coupling -Cast Iron	10

Torsion Tubes & Shafts

Torsion Tubes

- Torsion tubes are heavy duty 14 gauge tubing
- Available in 16' 8" and 18' 8"

Solid Torsion Shafts

- Solid shaft 1" diameter
- Keyed full length
- Available in 11' 1" and 17' 1"
- 1 1/4" solid torsion shaft by special order
- Other lengths available by special order



Stock	Description
231850	1" OD x 16' 8" 14 gauge Torsion Tube
231860	1" OD x 18' 8" 14 gauge Torsion Tube
231810	1" OD x 11' 1" Solid Keyed Torsion Shaft
231816	1" OD x 17' 1" Solid Keyed Torsion Shaft

Shaft Collars

Steel Shaft Collars

- Used to prevent the torsion shaft from walking on single spring steel doors
- Inside diameter - 1.010"
- Outside diameter - 1.50"
- 5/16" diameter, hardened cup point set screw included
- Zinc plated finish
- 1 1/4" shaft collar by special order



Stock	Description	Box Qty
231870	Steel Shaft Collar - 1" ID	50

Direct Dial: (817) 834-7300

Hangers & Trolleys

107-L

- Adjustable, pivot and swing free action
- Doors 1 1/2" to 2 3/8" thickness
- 2 1/8" diameter roller
- Includes four 5/16" carriage bolts per pair
- Ball bearings
- Supports door up to 400 lbs.
- Sold in pairs



Stock	Description
233275	Sliding Door Adjustable Pivot Trolleys

302-T Trolley

- Popular bolt thru design speeds installation
- Long 1/2" x 10" bolt can be used with a variety of door materials
- Exclusive girt clip feature
- Cam-action lateral adjustment and generous vertical adjustment
- 2 1/8" diameter roller
- Supports 400 lbs per trolley
- Sold in pairs



Stock	Description
233271	Sliding Door Bolt thru Trolley

100-HD

Sliding Door Strap Hanger Trolley

- Economical, yet built for durability
- One-piece apron door strap hanger is laterally and vertically adjustable
- Comes with bolts for attaching door
- 2 1/8" diameter roller
- Supports door up to 400 lbs.
- Sold in pairs



Stock	Description
233272	Sliding Door Strap Hanger Trolley

102-SI-T

Sliding Door Bolt Thru Trolleys

- Vertically adjustable with a rigid bolt
- Bolt is 1/2" x 4 1/2" with 2" thread and two hex nuts
- 201/8" diameter roller
- Supports door up to 400 lbs.
- Sold in pairs



Stock	Description
233273	Sliding Door Bolt Thru Trolley

Additional sliding door hardware available by special order.
Contact Customer Service.
(817) 834-7300

Email: sales@natdoor.com



Double Track Brackets

Sliding Door Track Bracket - Double

- Heavy Galvanized steel
- Mounting hole accommodates 3/8" lag screws or bolts
- Single track runs - space every 30"
- Double track runs - space every 24"



Stock	Description
233240	Sliding Door Track Bracket - Double

Single Track Brackets

Sliding Door Track Bracket

- Single piece heavy galvanized steel
- Mounting hole accommodates 3/8" lag screws or bolts
- Use to join multiple sections of track
- Single or double track models



Stock	Description
233220	Sliding Door Track Bracket - Single

Blind End

Sliding Door Track End Blind

- Snaps into track bracket to keep track free from birds, weather and other obstructions

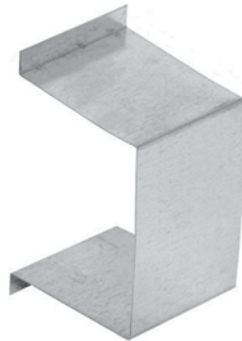

Stock	Description
233260	Sliding Door Track End Blind

Door Binder/Stop

Sliding Door Binder/Stop

- Offset is 2" x 3 1/4"
- Overall length is 7 3/8"
- Hot galvanized with holes to accept 3/8" lag screws or bolt



Stock	Description
233290	Sliding Door Binder/Stop

Sliding Door Track

Sliding Door Track

- Versatile and popular
- Use with any Box Track Brackets
- For single track runs, space brackets 24" on center
- Double-track runs require brackets every 18" on center
- 16 gauge galvanized steel

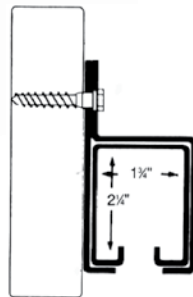
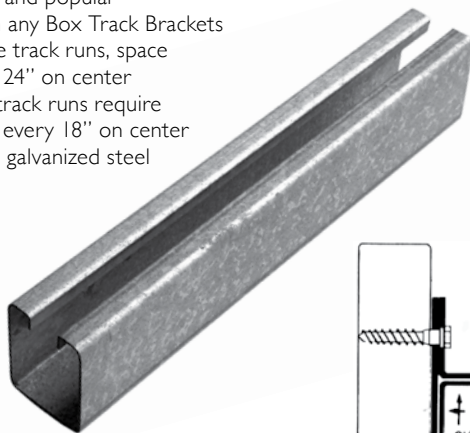

Stock	Description
233206	Sliding Door Track - 8' length
233208	Sliding Door Track - 10' length
233210	Sliding Door Track - 12' length

Other lengths available by special order

Offset Stay Roller

Sliding Door Heavy-Duty Offset Stay Roller

- Adjusts from 1" to 3 3/4" for a wide range of door widths
- Offset slots allow for full contact with door
- Non-marking rubber wheel mounted on 1/2" bolt

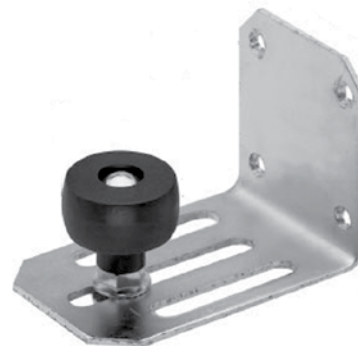

Stock	Description
233280	Sliding Door Heavy-Duty Offset Stay Roller

Additional sliding door hardware available by special order. Contact Customer Service. (817) 834-7300

Direct Dial: (817) 834-7300

Stainless Steel Hardware - Factory Direct Only

Stainless Steel Top Bracket

- Universal design
- Adjustable from 2" to 3-1/2"
- Fits most sectional doors

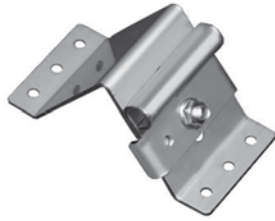

Stainless Steel Top Bracket - Extra Tall

- Adjustable from 3" to 4-3/4"
- Fits most sectional doors



Stainless Steel Low Headroom Top Bracket

- Universal design
- Fits most sectional doors
- For low headroom track



Stainless Steel Bottom Bracket

- For 1-5/8" to 2" doors
- Fits 2" or 3" track
- Includes pins and cotters



Stainless Steel Bottom Bracket

- For 2" doors
- Fits 2" or 3" track
- Double end stile
- Includes pins and cotters



Stainless Steel Bottom Bracket

- For 3" doors
- Fits 2" or 3" track
- Single end stile
- Includes pins and cotters



Stainless Steel Bottom Bracket

- For 3" doors
- Fits 2" or 3" track
- Double end stile
- Includes pins and cotters



Stainless Steel Bottom Bracket Low Headroom

- For low headroom track
- For 3" doors
- Fits 2" or 3" track
- Single end stile
- Includes pins and cotters



Stock	Description
222425	Stainless Steel Garage Door Top Bracket - 12 gauge
222426	Stainless Steel Garage Door Top Bracket - Extra Tall
222427	Stainless Steel Low Headroom Garage Door Top Bracket
222428	Stainless Steel Bottom Bracket - 1 5/8" to 2" Door
222429	Stainless Steel Bottom Bracket - 2" Door - Double End Stile
222430	Stainless Steel Bottom Bracket - 3" Door - Single End Stile
222431	Stainless Steel Bottom Bracket - 3" Door - Double End Stile
222432	Stainless Steel Bottom Bracket - Low Headroom

Email: sales@natdoor.com



Stainless Steel Hardware - Factory Direct Only

Stainless Steel Hinges

12 Gauge Stainless Steel Hinge

- Manufactured with heavy duty 12 gauge rust-proof 304 stainless steel
- Universal design
- Fits most sectional doors



Stock	Description
222410-01	Stainless Steel #1 Hinge - 12 Gauge
222410-02	Stainless Steel #2 Hinge - 12 Gauge
222410-03	Stainless Steel #3 Hinge - 12 Gauge
222410-04	Stainless Steel #4 Hinge - 12 Gauge
222410-05	Stainless Steel #5 Hinge - 12 Gauge
222410-06	Stainless Steel #6 Hinge - 12 Gauge
222410-07	Stainless Steel #7 Hinge - 12 Gauge
222410-08	Stainless Steel #8 Hinge - 12 Gauge
222410-09	Stainless Steel #9 Hinge - 12 Gauge
222410-10	Stainless Steel #10 Hinge - 12 Gauge
222410-11	Stainless Steel #11 Hinge - 12 Gauge
222410-12	Stainless Steel #12 Hinge - 12 Gauge

Stainless Steel Combination Hinge

- Direct replacement for Clopay style hinges
- Heavy duty 12 gauge rust-proof stainless steel



Stainless Steel Full Vision Hinge

- Direct replacement for Clopay style hinges
- Heavy duty 12 gauge rust-proof stainless steel



Stainless Steel Cut-Down Hinge

- Direct replacement for Overhead Door style hinges
- Heavy duty 12 gauge rust-proof stainless steel



Stock	Description
222420	Stainless Steel Combination Hinge
222421	Stainless Steel Full Vision Hinge
222422	Stainless Steel Cut-Down Hinge

Stainless Steel Shafts

Stainless Steel 1" Keyed Torsion Shaft

- Solid Shaft
- Rust Proof 304 Stainless Steel
- 1" Diameter



Stock	Description
222440	1" Stainless Steel Keyed Torsion Shaft - 6' Long
222441	1" Stainless Steel Keyed Torsion Shaft - 12' Long

Keystock- Stainless Steel

- 1/4" solid stock
- 3" length
- Rust proof 304 stainless steel
- Fits drums, spring winding cones, couplers and torsion shafts



Stainless Steel Greaseable Bearing with Aluminum Flange, 1"

- 1" I.D - 304 stainless steel insert
- Anodized aluminum housing
- 3/8" diameter mounting holes
- 3" hole to hole dimension



Stainless Steel Pusher Springs 15"

- Heavy duty 12 ga. 304 stainless steel barrel and mounting bracket
- Stainless steel spring
- High quality rubber door stop



Stock	Description
222442	Stainless Steel Keystock
222444	1" Stainless Steel Greaseable Bearing with Aluminum Flange
222443	Stainless Steel Pusher Springs 15" length

Stainless Steel Plates

Stainless Steel Hi-Lift Head Plate

- Heavy duty 12 gauge 304 stainless steel bracket
- Stainless greaseable bearings
- Use for 2" track

Stainless Steel Hi-Lift Head Plate

- Heavy duty 12 gauge 304 stainless steel bracket
- Stainless greaseable bearings
- Use for 3" track

Stainless Steel Hi-Lift with Vertical Headplates

- Heavy duty 12 gauge 304 stainless steel bracket
- No bearings

Stock	Description
222450-2	Stainless Steel Hi-Lift Head Plate with Greaseable Bearing - 2" Track
222450-3	Stainless Steel Hi-Lift Head Plate with Greaseable Bearing - 3" Track
222451	Stainless Steel Hi-Lift with Vertical Headplates - No Bearings



Direct Dial: (817) 834-7300

Stainless Steel Hardware - Factory Direct Only

Stainless Steel Plates

Center Bearing Plate

- Heavy duty 12 gauge 304 stainless steel brackets
- Center of bearing to wall - 3 3/8" to 6"
- Includes stainless steel fasteners

Extra wide for 6" I.D. springs

Extra wide for 6" I.D. springs



Universal Adjustable Bearing Plate with Greaseable Bearing

- Heavy duty 12 gauge 304 stainless steel bracket
- Adjustable from 3-3/8" to 6"
- Includes stainless steel fasteners
- Please indicate right or left hand flange if required

End Bearing Plate Greaseable Bearing

- Heavy duty 12 gauge 304 stainless steel brackets
- 3 position bearing placement 3 3/8", 4 3/8", 5" from wall
- Includes stainless steel fasteners

2 Position End Bearing Plates with Greaseable Bearing

- Heavy duty 12 gauge 304 stainless steel brackets
- 2 position bearing placement 5" and 6" from wall
- Includes stainless steel fasteners

222466



222468



222467



Stock	Description
222460	3 3/8" Stainless Steel Center Bearing Plate with Greaseable Bearing
222461	4 3/8" Stainless Steel Center Bearing Plate with Greaseable Bearing
222462	4 3/8" Stainless Steel Center Bearing Plate with Greaseable Bearing - Extra Wide
222463	5" Stainless Steel Center Bearing Plate with Greaseable Bearing
222464	6" Stainless Steel Center Bearing Plate with Greaseable Bearing
222465	6" Stainless Steel Center Bearing Plate with Greaseable Bearing - Extra Wide
222466	Universal Adjustable Stainless Steel Bearing Plate with Greaseable Bearing
222467	2 Position Stainless Steel End Bearing Plates with Greaseable Bearing
222468	3 Position Stainless Steel End Bearing Plates with Greaseable Bearing

Email: sales@natdoor.com



Stainless Steel Hardware - Factory Direct Only

Stainless Steel Rollers

2" Stainless Steel Rollers

- Fits 2" track
- Short stem - 4 1/2"
- Long stem - 7 1/2"

3" Stainless Steel Rollers

- Fits 3" track
- Short stem - 4 1/2"
- Long stem - 7 1/2"

3" Bearingless Carwash Stainless Steel Rollers

- Fits 3" track
- Short stem - 4 1/2"
- Long stem - 7 1/2"



Stock	Description
222470	2" Stainless Steel Magnum Garage Door Roller - Short Stem
222471	2" Stainless Steel Magnum Garage Door Roller - Long Stem
222475	3" Stainless Stem Magnum Garage Door Roller - Short Stem
222476	3" Stainless Steel Magnum Garage Door Roller - Long Stem
222477	3" Stainless Steel Magnum Supreme (SP) Garage Door Roller - Long Stem
222480	3" Stainless Steel Bearingless Carwash Door Roller - Short Stem
222481	3" Stainless Steel Bearingless Carwash Door Roller - Long Stem

Stainless Steel Cable

- 7 x 19 stainless steel 100' roll
- Stainless steel cable assembly available via special order

Stock	Description
222445-125	1/8" Stainless Steel Cable
222445-156	5/32" Stainless Steel Cable
222445-187	3/16" Stainless Steel Cable
222445-250	1/4" Stainless Steel Cable
222446-125	1/8" Non-Rotating Stainless Steel Cable



Special Order Hardware?

Need a hardware item that we don't show?

Call or email our friendly and knowledgeable customer service representatives and ask if we can special order it for you

**(817)-834-7300
sales@natdoor.com**

LUBRICANTS



LUBRICANTS

PRIVATE LABEL LUBRICANT PROGRAM • AEROSOL
 SAMPLER • GLASS CLEANER • 200 CITRUS
 GREASER • 400 LUBE • 600 MOLI-LUBE • 800
 FOOD GRADE LUBE • 900 LUBE • GDL-1000 LUBE
 MULTI-PURPOSE GREASE • DOOR
 LOCK-EASE • HAND CLEANING WIPES • LOCK EASE
 PRIVATE LABEL LUBRICANT PROGRAM • GLASS

Private Label Lubricant Program

Private Labeling of our Spray Lubricants or Hand Wipes can be a natural addition to your advertising program and a great way to improve your service call value. Keep your good name in the customer's eye with custom labeled lubricants from National Door.

NO ART WORK CHARGES!!
Use your own Company Logo and Colors!

Great To Use For Your:

- Service Calls
- New Installations
- Over the Counter Sales
- Invites Repeat Business

Order must be:

54 case quantity for Private Label

24 case quantity for Private Label Hand Wipes

Contact customer service about our Private Label Program



Stock	Description	Case
101005	400 Heavy Duty Lubricant 15 oz (12 cans/case)	54
101006	400 Heavy Duty Lubricant 6.5 oz (12 cans/case)	54
101009	900 Heavy Duty Lubricant 15oz (12 cans/case)	54
101019	GDL-1000 Medium Viscosity Silicone Lubricant 13 oz (12 cans/case)	54



Recommended File Format For Highest Quality Results . . .

Vector based artwork provides the best quality of image for your logo.

A vector image or graphic is a type of image defined on a plane, connected by lines and curves. They form shapes based on mathematical equations. And because of this, if you zoom in or out, the lines, curves, or points always remain smooth. Common file formats are CDR, AI, EPS, SVG and some PDF's.

Raster images are made up of a bunch of tiny pixels. Common files formats are PNG, JPG, BMP etc. The source of these primarily come from scans or pictures of original artwork. Scanning your business card will not provide a very good image. We can do our best at converting for you, but suggest you use one of the online services to vectorize your image. Many are less than \$20 to convert. If you want us to give it a whirl, scan it at the largest format you can and as close to full page size as possible.

Once we get your logo we will place it onto our can design and email it to you for a proof. Sign off on the proof and we'll get the ball rolling.

Direct Dial: (817) 834-7300

National Door Glass Cleaner

- Excellent for use on any non-porous surface unaffected by water, such as:
 - Windows
 - Plexiglass
 - Mirrors
 - Appliances
 - Light fixtures
 - Windshields
- 12 cans per case

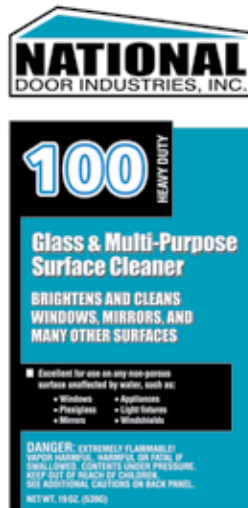

Stock	Description
102000	100 National Door Glass Cleaner - 19 oz

National Door Citrus Degreaser

- All purpose cleaner, degreaser, spot remover and odor counteractant
- 12 cans per case
- Designed to remove grease, oils, fingerprints, and other contaminations

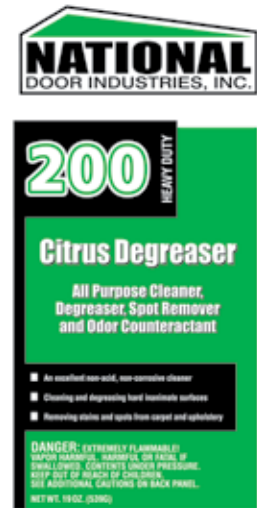

Stock	Description
102010	200 National Door Citrus Degreaser - 19 oz

National Door 400 Lube

- For all normal and heavy-duty use applications
- Safe around electrical components and areas to be painted
- Special adjustable 3-way nozzle
- Penetrates, loosens frozen parts, stops rust and corrosion, dissolves grease and grime
- Eliminates call backs
- Available in 6.5 oz or 15 oz
- Contains no methylene chloride
- Best if used within 18 months of purchase
- See previous page for Private Label details
- 12 cans per case
- VOC compliant

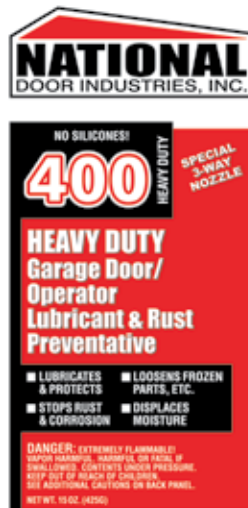

Contains NO SILICONE

Stock	Description
100005	400 National Door Lube - 15 oz Aerosol
100006	400 National Door Lube - 6.5 oz Aerosol

National Door 400-XD Lube

- For all normal, heavy-duty, and extreme use applications
- Safe around electrical components and areas to be painted
- Citrus scent
- Special adjustable 3-way nozzle
- Penetrates, loosens frozen parts, stops rust and corrosion, dissolves grease and grime
- Eliminates call backs
- Contains no methylene chloride
- Best if used within 18 months of purchase
- 12 cans per case
- VOC compliant



Contains NO SILICONE

Stock	Description
100005XD	400-XD National Door Lube - 15 oz Aerosol

National Door 600 Moli-Lube

- Great for rusted springs
- Turns rust black
- Doesn't rub off
- High pressure lubricant
- Effective to 1000° F
- Reduces friction and wear
- Best if used within 18 months of purchase
- Available in 13 oz professional size
- 12 cans per case



Stock	Description
100015	600 National Moli-Lube - 13 oz Aerosol

National Door 800 Food Grade Lube

- All purpose food grade lubricant
- Environmentally friendly
- Vegetable oil based
- Rust inhibitor
- Spray valve works in any position
- Extension tube included for pinpoint applications
- Approved for use in FDA meat and poultry plants and other food related industries
- Available in 12 oz
- 12 cans per case
- VOC compliant



Stock	Description
100050	800 National Food Grade Lubricant - 12 oz

National Door 900 Lube

- Heavy-duty, low temperature Lubri-Spray
- White lithium based grease lubricant
- Recommended for all screw and chain drive operators
- Prevents wear
- Stops rust and corrosion
- Eliminates call backs
- Available in 15 oz
- Best if used within 18 months of purchase
- Cold temperature rated
- 12 cans per case

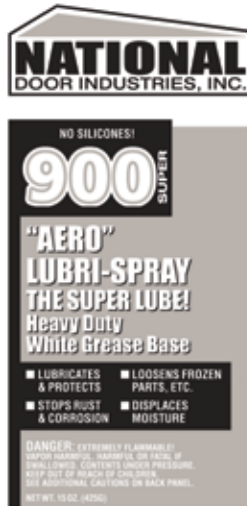

Contains NO SILICONE

Stock	Description
100009	900 National Door Lube - 15 oz Aerosol

National Door GDL-1000 Lube

- Medium viscosity silicone lubricant
- No gumming
- Reduces friction
- Prevents locks from freezing
- Not for electrical contacts
- Do not use on paintable surfaces
- Approved for use in FDA meat and poultry plants
- Available in 13 oz
- Do not use on electrical switches or other components
- Best if used within 18 months of purchase
- Contains silicone
- 12 cans per case

Note: Be careful using any product that contains silicone, as it can cause paint failure when it is applied on a painted surface.



Stock	Description
100019	GDL-1000 National Silicone Lubricant - 13 oz

Direct Dial: (817) 834-7300

Hand Cleaning Wipes

- Waterless hand cleaning towels
- Industrial strength
- Towel has abrasive side to loosen soil and a smooth side to wipe surface clean
- Non-scratching
- Leaves no residue
- Citrus scented and gentle, won't crack or dry hands
- Wipes dirt, oil and grease smudges from doors
- Private label wipes available in 24 cases (144 tubs)



Stock	Description	Case
100020	National HD Hand Cleaning Wipes 90 count 10" x 12"	
100030	Heavy Duty Hand Wipes 90 count 10" x 12" (6 tubs/case)	24

National Door Aerosol Sampler

- Not sure which lube is right for you?
- Try National Door's Sampler case to find which one you like best



2 Cans

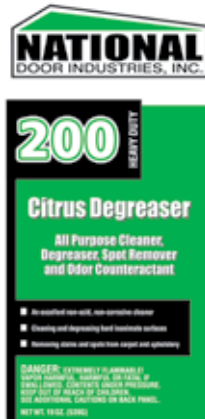

2 Cans



2 Cans



1 Can



1 Can



2 Cans



2 Cans

Stock	Description
100011	National Door Lubricant Sampler

Email: sales@natdoor.com



Lubriplate Multi-Purpose Grease

- Heavy-Duty, low temperature lubriplate white lithium based grease
- Meets manufacturers specifications for screw drive operators
- Quiets noisy doors and operators
- Recommended for all screw drive and chain drive operators
- 10 oz tube or 1 3/4 oz tube
- Try our convenient LubriSpray 900 Lube

Stock	Description
100012	1 3/4 oz tube - Aero Lubriplate
100013	10 oz tube - Low-Temp Lubriplate



Door Ease

- Stick Lubricant
- Prevents binding and sticking of door and jamb
- Stops squeaks
- Provides a dry, long lasting, non-oily and non-staining weatherproof lubricating film
- Clean and easy to apply - use like a crayon
- Recommended for all friction surfaces

Stock	Description
100025	4" x 1" Door Ease Stick Lubricant



Lock Ease

- Lock Fluid
- Contains colloidal graphite that penetrates to every part of locks
- Application leaves a long wearing film which protects against rust and wear
- Provides a rust retardant and water repellent lubricating film which withstands weather extremes
- There is no substitute for this product

Stock	Description
100026	Lock Ease - 3.4 oz Graphited Lock Fluid



TOOLS

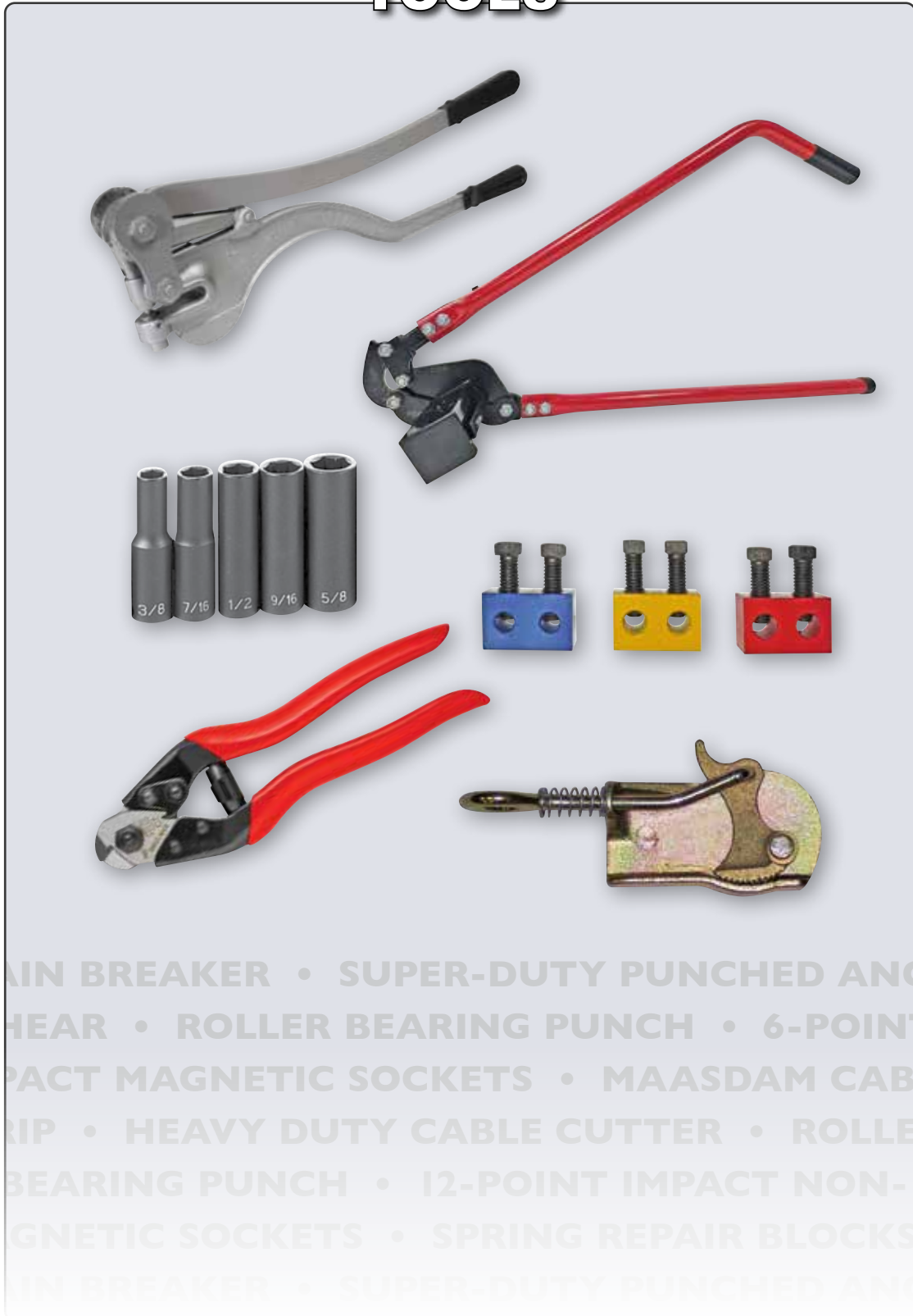

TOOLS

Super-Duty Punched Angle Shear

- Powder coated for durability
- Cutting blades manufactured from heat treated steel
- Zinc plated fasteners
- One year warranty on blades
- Serialized for trackability
- Designed to cut both residential and commercial grade steel up to 2" x 2" 12 gauge angle iron or lighter



Stock	Description
162100	Super-Duty Punched Angle Shear

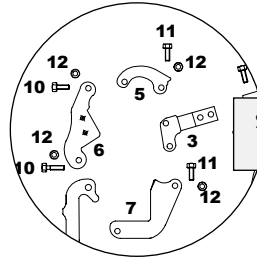

Super-Duty Replacement parts and exploded view can be found in the appendix

Big Red Door Hanger Shear

- Designed especially for the garage door industry
- Easily cuts 1/8" thick 2" x 2" angle with minimum effort
- Depth of cut is 3"
- Weighs only 35 lbs
- Designed for long trouble free service
- Cuts one side at a time
- Replacement blades available
- Made in the USA



Stock	Description
162290	Big Red Door Hanger Shear
162292	Model B Replacement Blades - (1 small and 1 large)

Open Throat Shear

Number 38 Roper Whitney Shear

- 5" blade
- Will cut up to 3/16" mild steel



Stock	Description
162295	Whitney Open Throat Shear
162296	Lower Replacement Blade for 38 Shear
162297	Upper Replacement Blade for 38 Shear

Direct Dial: (817) 834-7300

Whitney Angle Shear

Number 4 - Whitney Shear

- Cuts up to 2" x 2" x 1/4" angle iron
- 1/4" or lighter steel
- Includes 72" handle for proper leverage
- Heavy duty cast iron frame

See Appendix for all Replacement Parts

Stock	Description
162400	Whitney Angle Shear
162500	Replacement Shear Blade
162600	Replacement Base Blade - 2 piece set
162601	Replacement Handle 72" length



Roller Bearing Punch

Number 7 Roper Whitney

- 2 1/2 ton punching power, for 16 gauge or lighter material
- Leverage design provides easy operation
- 1 5/8" throat depth
- Comes with 1/4" punch and die

See Appendix for all Replacement Parts

Stock	Description
162700	Whitney Roller Punch
162800	Replacement Punch & Die for #7 Punch
162802	Replacement Punch & Die for #7 Punch



Number 8 Roper Whitney

- 5 ton punching power, 1/4" hole in 1/4" mild steel
- Leverage design provides easy operation
- 2 1/8" throat depth
- Comes with a 9/32" punch and die

See Appendix for all Replacement Parts

Stock	Description
162900	Whitney Roller Punch
163220	Replacement Punch & Die for #8 Punch
163221	Replacement Punch & Die for #8 Punch
163222	Replacement Punch & Die for #8 Punch
163223	Replacement Punch & Die for #8 Punch
163224	Replacement Punch & Die for #8 Punch



Aviation Snips

- Withstands strain of cutting heavy stock and tight curves
- Sprint-action for fast, effortless feed
- Handy hang-up hole
- Non-slip textured grips and safety latch for superior control

Stock	Description
186901	Aviation Snips - Straight or Tight Left
186902	Aviation Snips - Straight or Tight Right
186903	Aviation Snips - Straight & Wide Curves



Email: sales@natdoor.com

Come A-Long

- Easy to use
- Highly durable
- Precision fit, steel alloy pawls and 1 piece aluminum alloy ratchet wheel
- Notch-at-a-time letdown for positive control
- OSHA recommended safety latches
- Non-slip plastic grip provides permanent comfortable use and reduces hand fatigue
- 1 ton capacity has 12 foot maximum lift
- 2 ton capacity has 6 foot maximum lift
- Made in the USA

Stock	Description
166700	MAASDAM Power Pull - 2000 lb
166800	MAASDAM Power Pull - 4000 lb



**Saves untold hours in repairs
Eliminates unwinding of springs**



Maasdam Cable Grip

- Handles smooth or barbed wire as small as 5/32 inch
- Cam action insures tighter lock
- Shields and protects hands from barbed wire
- 1,000 lb. capacity
- Cast malleable iron, plated to prevent rusting
- Use with Maasdam Power Pull

Stock	Description
166311	Maasdam Cable Grip Economy Tool



Klein Cable Grip

- Ideal for bare ACSR, aluminum, and stranded copper cables
- Smooth jaws grip with maximum contact and are less likely to damage conductors
- 4,500 lb. capacity
- Made in the USA

Stock	Description
166300	Klein Cable Grip - Heavy Duty Tool



Direct Dial: (817) 834-7300

Vise Grip® Locking Pliers and Tools

- Micro adjustment for quick pre-adjustment and repeat clamping
- Locks work with a hand squeeze
- Classic trigger release provides maximum locking force

Stock	Description
186100	Vise Grip Curved Jaw Locking Plier - 10"
186200	Vise Grip Curved Jaw Locking Plier - 7"
186300	Vise Grip Curved Jaw Locking Plier - 5"



Stock	Description
186500	Locking C-Clamp - 11"
186510	Locking C-Clamp with Swivel Pads - 11"



Stock	Description
186700	Locking Welding Clamp - 9"



HSC-600 Cable Swaging Tool

- Swags 1/16" thru 3/16" cable
- Cuts up top 3/16" wire

Stock	Description
167000	Cable Swaging Tool w/cutter
167004	Replacement Head for HSC-600



Bench Swaging Tool

- Swags 1/16" thru 3/16" cable

Stock	Description
167003	Bench Swaging Tool w/cutter



HS-750 Cable Swaging Tool

- Swags 1/4" cable fittings
- Made in USA

Stock	Description
167001	Cable Swaging Tool for 1/4" Cable



Email: sales@natdoor.com

Felco Cable Cutter

- Swiss made cutter
- Cuts up to 3/16" cable

Stock	Description
167102	Felco Swiss Made Cable Cutter



Cable Cutter

- Cuts up to 3/16" cable

Stock	Description
167100	Cable Cutter



RC-450 Heavy-Duty Cable Cutter

- Cuts up to 1/2" cable
- Cuts steel and stainless steel cable only

Stock	Description
167200	Heavy Duty Cable Cutter



Chain Breaker

- Use for chain sizes #25 through #60 chain
- Removes pins to shorten or repair chain
- Sold with 1 replacement pin

Stock	Description
165800	Chain Breaker

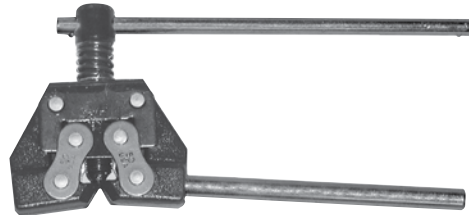

Chain Holder

- Holds #35 - #80 chain
- Light and easy to use
- Allows chain to be pulled or released without dropping or readjusting sprockets
- Made in the USA

Stock	Description
165702	Chain Holder



Chain Puller

- #35 - For 35 through 60 chain
- #50 - For 40 through 80 chain
- Made in the USA

Stock	Description
165700	Mainheim #35 - #60 Chain Puller
165701	Mainheim #40 - #80 Chain Puller

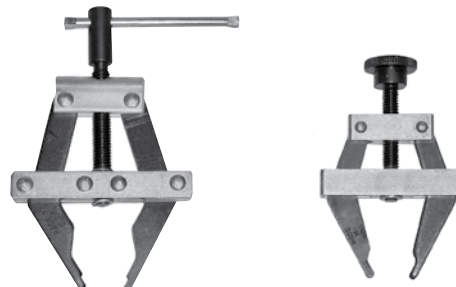

Direct Dial: (817) 834-7300

Spring Repair Blocks

For **TEMPORARILY** repairing a broken torsion spring. **NOTE!** this is only a short term solution to replacement of the springs. The spring repair blocks **MUST** be used in pairs, **DO NOT** put just a single repair block on the spring. **Use extreme caution when using this product!**

Stock	Description
217400	Blue Spring Repair Block - 1 pair
217500	Yellow Spring Repair Block - 1 pair
217600	Red Spring Repair Block - 1 pair



Three different sizes for different ranges of wire sizes

- Blue - wire sizes ranging from .2187" to .3065"
- Yellow - wire sizes ranging from .3175" to .3625"
- Red - wire sizes ranging from .3750" to .4305"

Spring Wire Gauge

- The Residential Gauge measures wire size .187 to .312
- The Commercial Gauge measures wire size .319 to .562
- Gauges are stainless steel and have the wire size stamped on each gauge for easy identification

Stock	Description
231985	Residential Spring Gauge .187 - .312
231986	Commercial Spring Gauge .319 - .562



National Door Spring Wire Gauge

Stock	Description
231990	National Door's Spring Wire Gauge



Track Straightening Tool

- Use National Door's Track Straightening Tool as an anvil to straighten bent track
- 8" length
- Used for 2" track

Stock	Description
225001	8" Track Straightening Tool for 2" Track



Counter Balance Arm

STOP Guessing Door Weight!

- National Door's Counter Balance Arm (CBA) is used to find the weight of a door
- To measure the door weight, place the CBA on the scale and then let the door down onto the small tube welded on top of the CBA
- Release the tension on the springs of the door and read the scale
- Take that weight on the scale and multiply starting at 4.6 and go as high as 5.5 to get the weight of the door

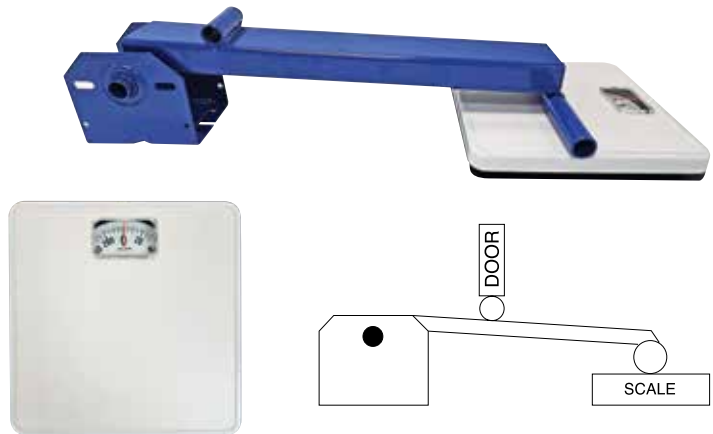

Stock	Description
225005	Counter Balance Arm
225006	Analog Scale for Weighing Doors

Hand Staple Guns

Model T-25M

- 1/4" crown staples in the Model T-25 fits wires up to 1/4"
- Loads (85 ea.) T-25 staples

Model T-59

- 5/16" insulated staples in the Model T-59 fits wire up to 5/16"
- Insulated plastic coated staples

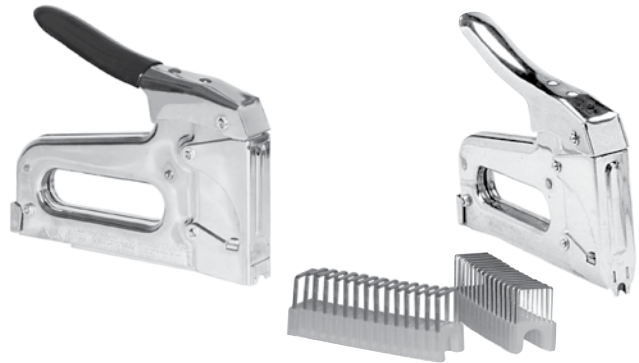

Stock	Description
165900	T-25M Staple Wire Tacker for 1/4" Wire
165901	9/16" Staples for T-25 Stapler - 5000/box
165920	T-59 Staple Wire Tacker for 1/4" - 5/16" Wire
165921	1/4" Insulated Staples for T-59 Stapler - 300/box

Saw Horse

- Made in the USA
- Sold in single units
- Folds for easy storage
- Galvanized finish

Stock	Description
187701	30" Saw Horse

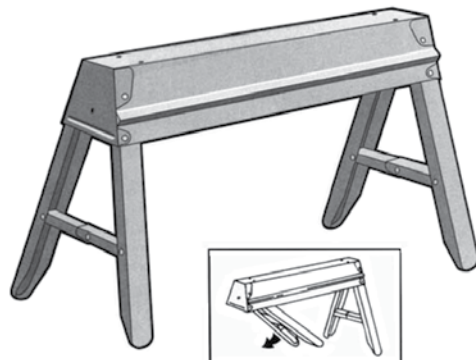

Direct Dial: (817) 834-7300

Hand Rivet Tools

- The perfect medium duty tool
- Sets 1/8" and 5/32" diameter steel rivets
- Sets up to 3/16" aluminum rivets

Stock	Description
160200	KRI Medium Duty Hand Rivet Tool



Good Option

- The HP-2 is supplied with four nose pieces needed to set 3/32", 1/8", 5/32" and 3/16" diameter aluminum or steel rivets

Stock	Description
160300	HP-2 Hand Rivet Tool - Heavy Duty



Better Option

- The BIG-DADDY is an extremely rugged tool engineered to set 1/8" to 1/4" rivets in all alloys

Stock	Description
160400	Extra Heavy Duty Rivet Tool

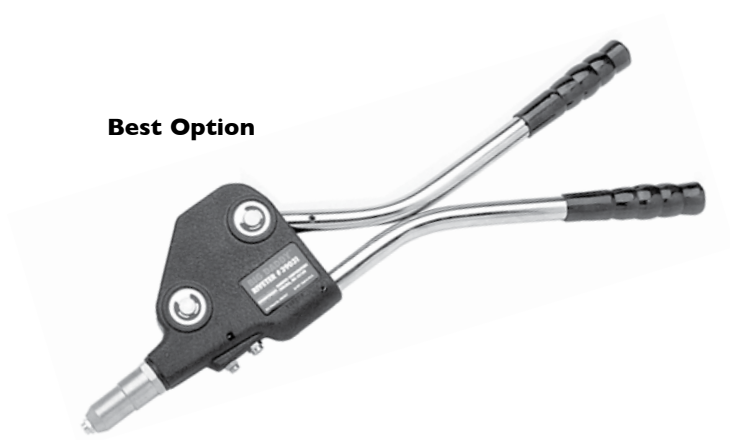

Best Option

Round and Hex Winding Bars

- Sold in pairs

Round

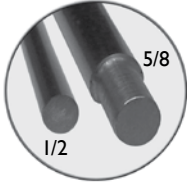

Hex

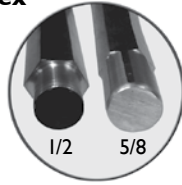

Stock	Description
164000	Round Winding Bar - 1/2" x 18"
164100	Round Winding Bar - 5/8" - 1/2" x 24"
164200	Round Winding Bar - 5/8" - 1/2" x 30"
164600	Red Handled Round Winding Bar - 1/2" x 18"
164300	Hex Winding Bar - 1/2" x 18"
164400	Hex Winding Bar - 5/8" - 1/2" x 24"
164500	Hex Winding Bar - 5/8" - 1/2" x 30"
164550	Red Handled Hex Winding Bar - 1/2" x 18"

Magnetic Hex Drivers

- Designed for driving sheet metal screws
- Features strong magnets for maximum holding power
- 1/4 hex shank with quick release grooves
- Magnetic drive for screw guns and drills
- Great for driving Tek screws



Stock	Description
179500	1/4" Hex - 1/4" Magnetic Driver
179600	1/4" Hex - 5/16" Magnetic Driver
179700	1/4" Hex - 3/8" Magnetic Driver
179710	1/4" Hex - 7/16" Magnetic Driver

Hex Adapters

- 1/4 hex shank with quick release grooves
- For screw guns and drills
- Drive your sockets



Stock	Description
179200	1/4" Hex 3/8" Male Socket Adapter - 3" Long
179300	7/16" Hex 1/2" Male Socket Adapter - 3" Long

Extensions

- Impact socket extensions
- Black oxide alloy steel
- Heat treated



Stock	Description
182100-03	Socket Extension - 3/8" x 3"
182110-03	Socket Extension - 1/2" x 3"
182110-05	Socket Extension - 1/2" x 5"
182110-10	Socket Extension - 1/2" x 10"

6-Point Impact Magnetic Sockets



3/8" Drive - Standard

Standard Drive

Stock	Description
172000	3/8" Drive 6-point Socket - 1/4"
172100	3/8" Drive 6-point Socket - 5/16"
172200	3/8" Drive 6-point Socket - 3/8"
172300	3/8" Drive 6-point Socket - 7/16"
172400	3/8" Drive 6-point Socket - 1/2"
172500	3/8" Drive 6-point Socket - 9/16"
172700	1/2" Drive 6-point Socket - 5/16"
172800	1/2" Drive 6-point Socket - 3/8"
172900	1/2" Drive 6-point Socket - 7/16"
173000	1/2" Drive 6-point Socket - 1/2"
173100	1/2" Drive 6-point Socket - 9/16"



1/2" Drive - Standard

Deep Drive

Stock	Description
173300	3/8" Drive 6-point Deep Socket - 3/8"
173400	3/8" Drive 6-point Deep Socket - 7/16"
173500	3/8" Drive 6-point Deep Socket - 1/2"
173600	3/8" Drive 6-point Deep Socket - 9/16"
173700	3/8" Drive 6-point Deep Socket - 5/8"
173800	1/2" Drive 6-point Deep Socket - 3/8"
173900	1/2" Drive 6-point Deep Socket - 7/16"
174000	1/2" Drive 6-point Deep Socket - 1/2"
174100	1/2" Drive 6-point Deep Socket - 9/16"
174200	1/2" Drive 6-point Deep Socket - 5/8"



3/8" Drive - Deep



1/2" Drive - Deep

Direct Dial: (817) 834-7300

6-Point Impact Non-Magnetic Sockets

Standard Drive

Stock	Description
174310	3/8" Drive 6-Point Impact Socket - 5/16"
174311	3/8" Drive 6-Point Impact Socket - 3/8"
174400	3/8" Drive 6-Point Impact Socket - 7/16"
174500	3/8" Drive 6-Point Impact Socket - 1/2"
174600	3/8" Drive 6-Point Impact Socket - 9/16"
174700	1/2" Drive 6-Point Impact Socket - 3/8"
174800	1/2" Drive 6-Point Impact Socket - 7/16"
174900	1/2" Drive 6-Point Impact Socket - 1/2"
175000	1/2" Drive 6-Point Impact Socket - 9/16"
175100	1/2" Drive 6-Point Impact Socket - 5/8"

3/8" Drive - Standard



1/2" Drive - Standard

Deep Drive

Stock	Description
175200	3/8" Drive 6-Point Impact Deep Socket - 3/8"
175300	3/8" Drive 6-Point Impact Deep Socket - 7/16"
175400	3/8" Drive 6-Point Impact Deep Socket - 1/2"
175500	3/8" Drive 6-Point Impact Deep Socket - 9/16"
175510	3/8" Drive 6-Point Impact Deep Socket - 5/8"
175600	1/2" Drive 6-Point Impact Deep Socket - 3/8"
175700	1/2" Drive 6-Point Impact Deep Socket - 7/16"
175800	1/2" Drive 6-Point Impact Deep Socket - 1/2"
175900	1/2" Drive 6-Point Impact Deep Socket - 9/16"
176000	1/2" Drive 6-Point Impact Deep Socket - 5/8"

3/8" Drive - Deep



1/2" Drive - Deep

12-Point Impact Non-Magnetic Sockets

Deep Drive

Stock	Description
175550-3750	3/8" Drive 12-Point Impact Deep Socket - 3/8"
175550-4375	3/8" Drive 12-Point Impact Deep Socket - 7/16"
175550-5000	3/8" Drive 12-Point Impact Deep Socket - 1/2"
175550-5625	3/8" Drive 12-Point Impact Deep Socket - 9/16"
175650-3750	1/2" Drive 12-Point Impact Deep Socket - 3/8"
175650-4375	1/2" Drive 12-Point Impact Deep Socket - 7/16"
175650-5000	1/2" Drive 12-Point Impact Deep Socket - 1/2"
175650-5625	1/2" Drive 12-Point Impact Deep Socket - 9/16"

3/8" Drive - Deep



1/2" Drive - Deep

Socket Adapter

- 1 5/16" long
- Black oxide alloy steel
- Heat treated
- Designed for electric or air powered drive tools

Stock	Description
179000	1/2" Female to 3/8" Male Drive Socket Adapter
179010	3/8" Female to 1/2" Male Socket Adapter



Standard Drill Bits - High Speed for Steel

Standard Length

- Sold in pack quantities only. 6 bits per pack



Stock	Description
192000-125	High Speed Steel Drill Bit - 1/8"
192000-188	High Speed Steel Drill Bit - 3/16"
192000-250	High Speed Steel Drill Bit - 1/4"
192000-313	High Speed Steel Drill Bit - 5/16"
192000-375	High Speed Steel Drill Bit - 3/8"
192000-438	High Speed Steel Drill Bit - 7/16"
192000-500	High Speed Steel Drill Bit - 1/2"

6 Inch Length

- Sold in pack quantities only. 6 bits per pack



Stock	Description
192010-125	High Speed Steel Drill Bit - 1/8" x 6"
192010-188	High Speed Steel Drill Bit - 3/16" x 6"
192010-250	High Speed Steel Drill Bit - 1/4" x 6"
192010-313	High Speed Steel Drill Bit - 5/16" x 6"
192010-375	High Speed Steel Drill Bit - 3/8" x 6"
192010-500	High Speed Steel Drill Bit - 1/2" x 6"

12 Inch Length

- Sold in pack quantities only. 6 bits per pack



Stock	Description
192020-125	High Speed Steel Drill Bit - 1/8" x 12"
192020-188	High Speed Steel Drill Bit - 3/16" x 12"
192020-250	High Speed Steel Drill Bit - 1/4" x 12"
192020-313	High Speed Steel Drill Bit - 5/16" x 12"
192020-375	High Speed Steel Drill Bit - 3/8" x 12"
192020-438	High Speed Steel Drill Bit - 7/16" x 12"
192020-500	High Speed Steel Drill Bit - 1/2" x 12"

DeWALT Pilot Point Drill Bits

- Sold in pack quantities only. 6 bits per pack

Metal Drilling

- Drills precise, smooth holes with no burrs
- Drills up to four times faster than ordinary drill bits
- Lasts up to 7 times longer
- Minimizes walking - no center punch required
- No binding or lock-up at breakthrough
- Requires half the force of ordinary bits
- Ideal for drilling in sheet metal

Wood Drilling

- Minimizes walking, drills perfectly sized holes
- Eliminates splintering at start-up
- Prevents binding and lock-up at breakthrough

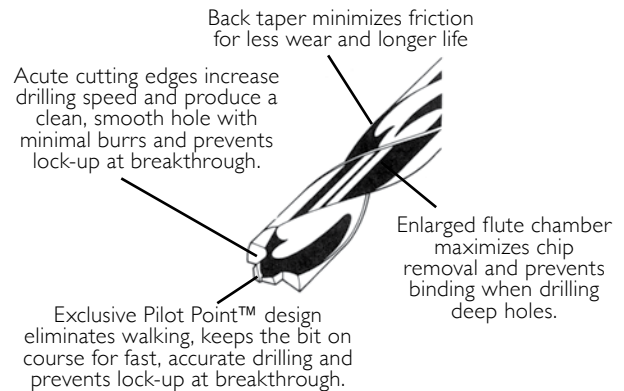

Stock	Description
192050-250	DeWALT Pilot Point Bit - 1/8"
192050-313	DeWALT Pilot Point Bit - 1/4"
192050-375	DeWALT Pilot Point Bit - 3/8"
192050-500	DeWALT Pilot Point Bit - 1/2"

Other sizes available by special order

Hole Saws and Mandrels

Bi-Metal Hole Saws

- Bi-metal hole saws offer fast cutting and improved resistance to impact
- They are ideally suited for use with all makes of electric drills. Hex 7/16" shank requires 1/2" or larger drill chuck
- Popular sizes for the door industry
- Use 1 1/8" for most lock installations
- Use 3 1/2" and 5 1/2" saws for exhaust port installation
- 1 1/8" depth of cut
- For cutting holes in almost any machinable material: steel, brass, copper, aluminum, wood, plastics and compositions



Stock	Description
193500	Hole Saw Mandrel 3/4" to 1 3/8" Hex Shank
193509	1 1/8" Hole Saw - Bimetal Long Life
193502	Hole Saw Pilot Bit - 1/4"

WEATHERSEAL

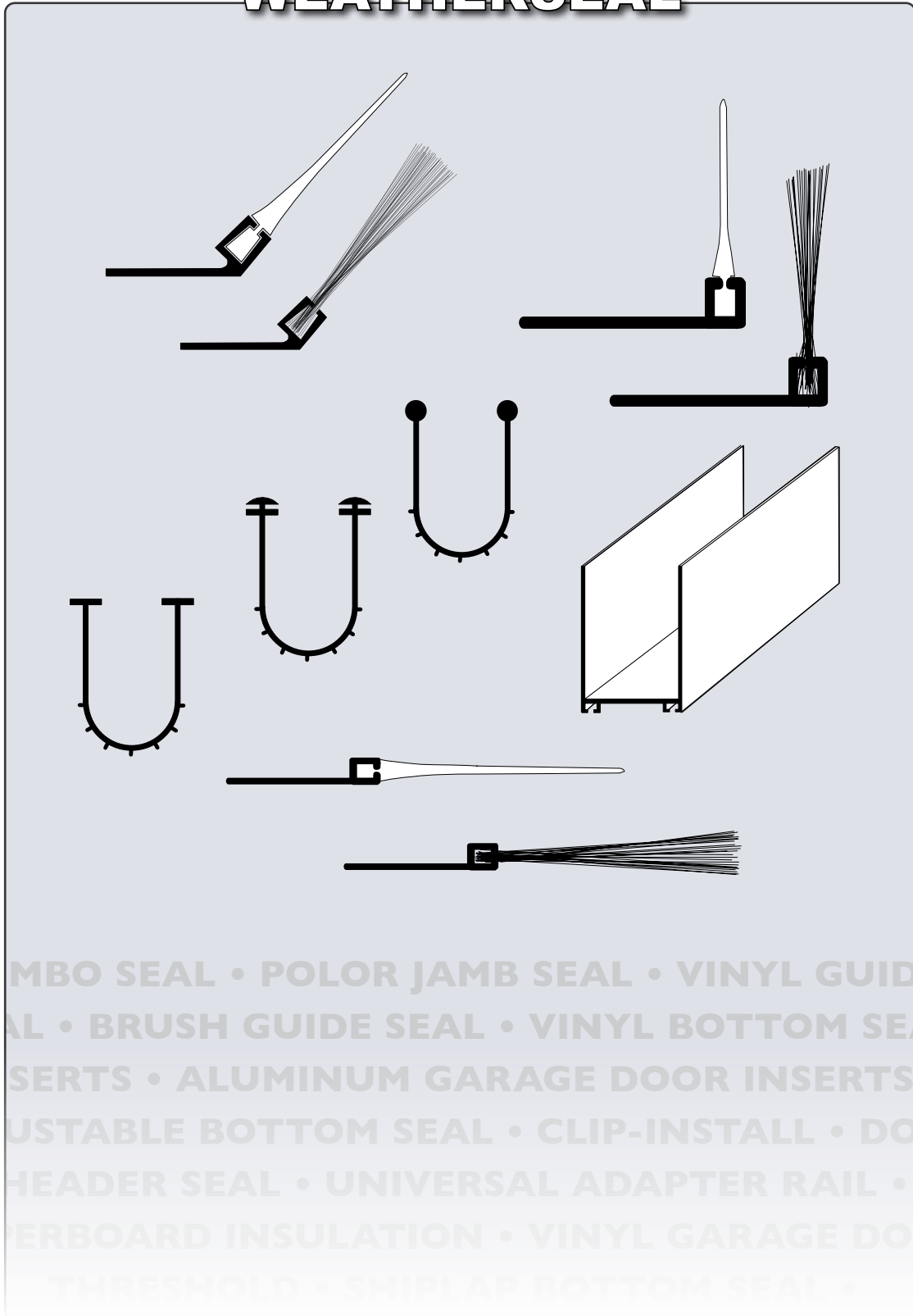

WEATHERSEAL

Jamb Up Door Seal

- Jamb Up is a co-extruded PVC door seal designed especially to work as a stop mold and as a weatherseal
- Premium quality rigid PVC with a special Cold Temp flexible vinyl insures a positive seal
- Woodgrain finish
- No splitting, warping, rotting, or paint peeling
- Cuts and nails just like real wood
- Available in White, Brown, Almond, Sandstone, Desert Tan, and Black
- Other colors available in minimum run quantities
- 8 convenient sizes: 7, 8, 9, 10, 12, 14, 16, and 18 feet
- Packed 15 pieces per carton. Sold in full cartons only
- Carton weight 4 pounds per linear foot
- Colored nails available
- Factory direct shipments only
- 36 carton minimum

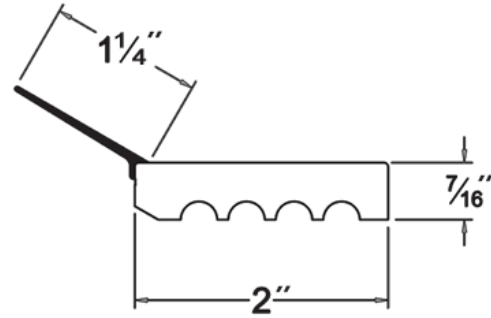

White

Stock	Length	Description	Pack
141901	7'	Jamb Up Door Seal - White - 15 pcs	105 ft/ctn
141902	8'	Jamb Up Door Seal - White - 15 pcs	120 ft/ctn
141903	9'	Jamb Up Door Seal - White - 15 pcs	135 ft/ctn
141904	10'	Jamb Up Door Seal - White - 15 pcs	150 ft/ctn
141905	12'	Jamb Up Door Seal - White - 15 pcs	180 ft/ctn
141906	14'	Jamb Up Door Seal - White - 15 pcs	210 ft/ctn
141907	16'	Jamb Up Door Seal - White - 15 pcs	240 ft/ctn
141908	18'	Jamb Up Door Seal - White - 15 pcs	270 ft/ctn

Sandstone

Stock	Length	Description	Pack
141901-04	7'	Jamb Up Door Seal - Sandstone - 15 pcs	105 ft/ctn
141902-04	8'	Jamb Up Door Seal - Sandstone - 15 pcs	120 ft/ctn
141903-04	9'	Jamb Up Door Seal - Sandstone - 15 pcs	135 ft/ctn
141904-04	10'	Jamb Up Door Seal - Sandstone - 15 pcs	150 ft/ctn
141905-04	12'	Jamb Up Door Seal - Sandstone - 15 pcs	180 ft/ctn
141906-04	14'	Jamb Up Door Seal - Sandstone - 15 pcs	210 ft/ctn
141907-04	16'	Jamb Up Door Seal - Sandstone - 15 pcs	240 ft/ctn
141908-04	18'	Jamb Up Door Seal - Sandstone - 15 pcs	270 ft/ctn

Brown

Stock	Length	Description	Pack
141901-01	7'	Jamb Up Door Seal - Brown - 15 pcs	105 ft/ctn
141902-01	8'	Jamb Up Door Seal - Brown - 15 pcs	120 ft/ctn
141903-01	9'	Jamb Up Door Seal - Brown - 15 pcs	135 ft/ctn
141904-01	10'	Jamb Up Door Seal - Brown - 15 pcs	150 ft/ctn
141905-01	12'	Jamb Up Door Seal - Brown - 15 pcs	180 ft/ctn
141906-01	14'	Jamb Up Door Seal - Brown - 15 pcs	210 ft/ctn
141907-01	16'	Jamb Up Door Seal - Brown - 15 pcs	240 ft/ctn
141908-01	18'	Jamb Up Door Seal - Brown - 15 pcs	270 ft/ctn

Desert Tan

Stock	Length	Description	Pack
141901-10	7'	Jamb Up Door Seal - Desert Tan - 15 pcs	105 ft/ctn
141902-10	8'	Jamb Up Door Seal - Desert Tan - 15 pcs	120 ft/ctn
141903-10	9'	Jamb Up Door Seal - Desert Tan - 15 pcs	135 ft/ctn
141904-10	10'	Jamb Up Door Seal - Desert Tan - 15 pcs	150 ft/ctn
141905-10	12'	Jamb Up Door Seal - Desert Tan - 15 pcs	180 ft/ctn
141906-10	14'	Jamb Up Door Seal - Desert Tan - 15 pcs	210 ft/ctn
141907-10	16'	Jamb Up Door Seal - Desert Tan - 15 pcs	240 ft/ctn
141908-10	18'	Jamb Up Door Seal - Desert Tan - 15 pcs	270 ft/ctn

Almond

Stock	Length	Description	Pack
141901-02	7'	Jamb Up Door Seal - Almond - 15 pcs	105 ft/ctn
141902-02	8'	Jamb Up Door Seal - Almond - 15 pcs	120 ft/ctn
141903-02	9'	Jamb Up Door Seal - Almond - 15 pcs	135 ft/ctn
141904-02	10'	Jamb Up Door Seal - Almond - 15 pcs	150 ft/ctn
141905-02	12'	Jamb Up Door Seal - Almond - 15 pcs	180 ft/ctn
141906-02	14'	Jamb Up Door Seal - Almond - 15 pcs	210 ft/ctn
141907-02	16'	Jamb Up Door Seal - Almond - 15 pcs	240 ft/ctn
141908-02	18'	Jamb Up Door Seal - Almond - 15 pcs	270 ft/ctn

Black

Stock	Length	Description	Pack
141901-11	7'	Jamb Up Door Seal - Black - 15 pcs	105 ft/ctn
141902-11	8'	Jamb Up Door Seal - Black - 15 pcs	120 ft/ctn
141903-11	9'	Jamb Up Door Seal - Black - 15 pcs	135 ft/ctn
141904-11	10'	Jamb Up Door Seal - Black - 15 pcs	150 ft/ctn
141905-11	12'	Jamb Up Door Seal - Black - 15 pcs	180 ft/ctn
141906-11	14'	Jamb Up Door Seal - Black - 15 pcs	210 ft/ctn
141907-11	16'	Jamb Up Door Seal - Black - 15 pcs	240 ft/ctn
141908-11	18'	Jamb Up Door Seal - Black - 15 pcs	270 ft/ctn

Direct Dial: (817) 834-7300

Painted Weatherstrip Nails

- 1 3/4" length
- Painted White, Brown, Almond, Sandstone, or Black
- Ring Shank for superior holding
- Great for Jamb Up Vinyl Perimeter Stop Mold
- Available in a 10 or 1 pound box

Stock	Description
I35900	Painted Weatherstrip Nails - White - 10 lb box
I35900-001	Painted Weatherstrip Nails - White - 1 lb box
I35901	Painted Weatherstrip Nails - Brown - 10 lb box
I35901-001	Painted Weatherstrip Nails - Brown - 1 lb box
I35902	Painted Weatherstrip Nails - Almond - 10 lb box
I35902-001	Painted Weatherstrip Nails - Almond - 1 lb box
I35904	Painted Weatherstrip Nails - Sandstone - 10 lb box
I35904-001	Painted Weatherstrip Nails - Sandstone - 1 lb box
I35905-001	Painted Weatherstrip Nails - Black - 1 lb box



Jumbo Seal - 5' and 7' Lengths - Vinyl and Brush

Jumbo Seal now sold in 5 and 7 foot lengths in any quantity!

- Heavy aluminum extrusion with vinyl or brush
- Sold by the piece
- Able to ship via UPS or FedEx
- Aluminum retainers sold in straight lengths, 45 degree and 90 degree angles
- 1 1/2", 2" or 3" brush available in 5' and 7' lengths
- 1 1/2", 2" or 3" grey vinyl available cut to length

Stock	Description
I44500	Style I5 5' - 1 1/2" Aluminum Weatherseal Retainer
I44501	Style 25 5' - 2 1/2" Aluminum Weatherseal Retainer
I44502	Style 35 5' - 3 1/2" Aluminum Weatherseal Retainer
I44505	Style I5 7' - 1 1/2" Aluminum Weatherseal Retainer
I44506	Style 25 7' - 2 1/2" Aluminum Weatherseal Retainer
I44507	Style 35 7' - 3 1/2" Aluminum Weatherseal Retainer
I44510	Style S150 5' - 1 1/2" Aluminum Weatherseal Retainer
I44511	Style S250 5' - 2 1/2" Aluminum Weatherseal Retainer
I44520	Style S150 7' - 1 1/2" Aluminum Weatherseal Retainer
I44521	Style S250 7' - 2 1/2" Aluminum Weatherseal Retainer
I44530	Style NI50 5' - 1 1/2" Aluminum Weatherseal Retainer
I44540	Style NI50 7' - 1 1/2" Aluminum Weatherseal Retainer
I44600	Style B150 5' - 1 1/2" Jumbo Seal Brush
I44601	Style B200 5' - 2" Jumbo Seal Brush
I44602	Style B300 5' - 3" Jumbo Seal Brush
I44610	Style B150 7' - 1 1/2" Jumbo Seal Brush
I44611	Style B200 7' - 2" Jumbo Seal Brush
I44612	Style B300 7' - 3" Jumbo Seal Brush
I44620	Style V150 1 1/2" Vinyl - Cut To Length
I44621	Style V200 2" Vinyl - Cut To Length
I44622	Style V300 3" Vinyl - Cut To Length

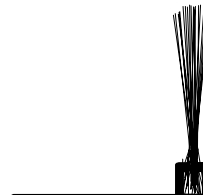
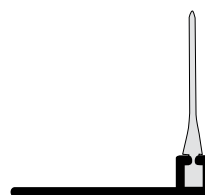
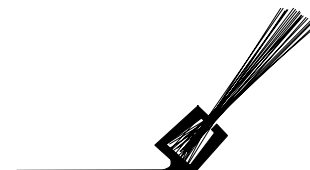
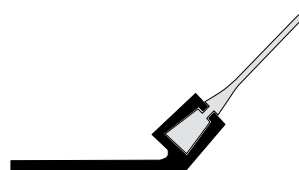

Email: sales@natdoor.com

Style 10 - JUMBO SEAL - 1 1/2" Vinyl or Brush

- 3/4" 45° aluminum retainer
- Heavy aluminum extrusion with vinyl or brush
- Sold in full cartons only

Stock	Description
I43817	Style 10 10' JUMBO SEAL with 1 1/2" Vinyl - Black - 20 pcs
I43818	Style 10 10' JUMBO SEAL with 1 1/2" Vinyl - Grey - 20 pcs
I43819	Style 10 10' JUMBO SEAL with 1 1/2" Vinyl - Brown - 20 pcs

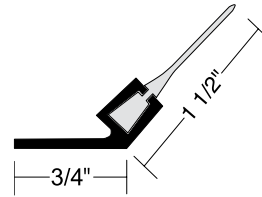

Style 15 - JUMBO SEAL - 1 1/2" Vinyl or Brush

- 1 1/2" 45° aluminum retainer
- Heavy aluminum extrusion with vinyl or brush
- Sold in full cartons only

Stock	Description
I43820	Style 15 10' JUMBO SEAL with 1 1/2" Vinyl - 10 pcs
I43821	Style 15 12' JUMBO SEAL with 1 1/2" Vinyl - 10 pcs
I43822	Style 15 14' JUMBO SEAL with 1 1/2" Vinyl - 10 pcs
I43823	Style 15 16' JUMBO SEAL with 1 1/2" Vinyl - 10 pcs
I43850	Style 15 10' JUMBO SEAL with 1 1/2" Brush - 10 pcs
I43851	Style 15 12' JUMBO SEAL with 1 1/2" Brush - 10 pcs
I43852	Style 15 14' JUMBO SEAL with 1 1/2" Brush - 10 pcs
I43853	Style 15 16' JUMBO SEAL with 1 1/2" Brush - 10 pcs

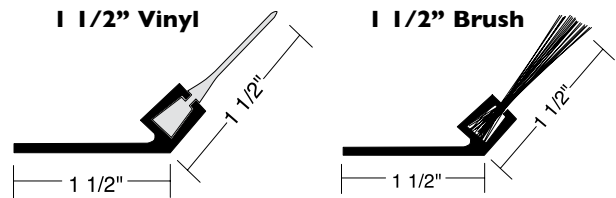

Style 15 - JUMBO SEAL - 2" Vinyl or Brush

Stock	Description
I43830	Style 15 10' JUMBO SEAL with 2" Vinyl - 10 pcs
I43831	Style 15 12' JUMBO SEAL with 2" Vinyl - 10 pcs
I43832	Style 15 14' JUMBO SEAL with 2" Vinyl - 10 pcs
I43833	Style 15 16' JUMBO SEAL with 2" Vinyl - 10 pcs
I43860	Style 15 10' JUMBO SEAL with 2" Brush - 10 pcs
I43861	Style 15 12' JUMBO SEAL with 2" Brush - 10 pcs
I43862	Style 15 14' JUMBO SEAL with 2" Brush - 10 pcs
I43863	Style 15 16' JUMBO SEAL with 2" Brush - 10 pcs

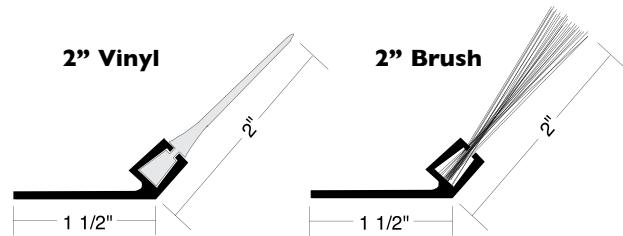

Style 15 - JUMBO SEAL - 3" Vinyl or Brush

Stock	Description
I43840	Style 15 10' JUMBO SEAL with 3" Vinyl - 10 pcs
I43841	Style 15 12' JUMBO SEAL with 3" Vinyl - 10 pcs
I43842	Style 15 14' JUMBO SEAL with 3" Vinyl - 10 pcs
I43843	Style 15 16' JUMBO SEAL with 3" Vinyl - 10 pcs
I43870	Style 15 10' JUMBO SEAL with 3" Brush - 10 pcs
I43871	Style 15 12' JUMBO SEAL with 3" Brush - 10 pcs
I43872	Style 15 14' JUMBO SEAL with 3" Brush - 10 pcs
I43873	Style 15 16' JUMBO SEAL with 3" Brush - 10 pcs

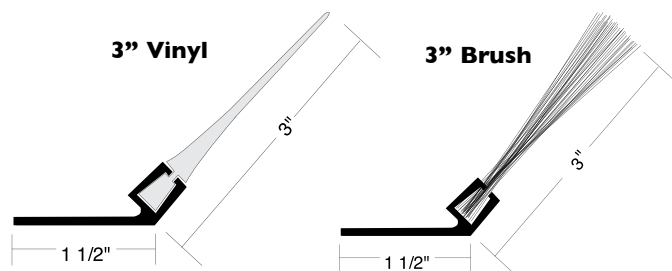

Vinyl and brush Jumbo Seal is food grade

Direct Dial: (817) 834-7300

Style 25 - JUMBO SEAL - 1 1/2" Vinyl or Brush

- 2 1/2" 45° aluminum retainer
- Heavy aluminum extrusion with vinyl or brush
- Sold in full cartons only

Stock	Description
I43880	Style 25 10' JUMBO SEAL with 1 1/2" Vinyl - 10 pcs
I43881	Style 25 12' JUMBO SEAL with 1 1/2" Vinyl - 10 pcs
I43882	Style 25 14' JUMBO SEAL with 1 1/2" Vinyl - 10 pcs
I43883	Style 25 16' JUMBO SEAL with 1 1/2" Vinyl - 10 pcs
I43910	Style 25 10' JUMBO SEAL with 1 1/2" Brush - 10 pcs
I43911	Style 25 12' JUMBO SEAL with 1 1/2" Brush - 10 pcs
I43912	Style 25 14' JUMBO SEAL with 1 1/2" Brush - 10 pcs
I43913	Style 25 16' JUMBO SEAL with 1 1/2" Brush - 10 pcs

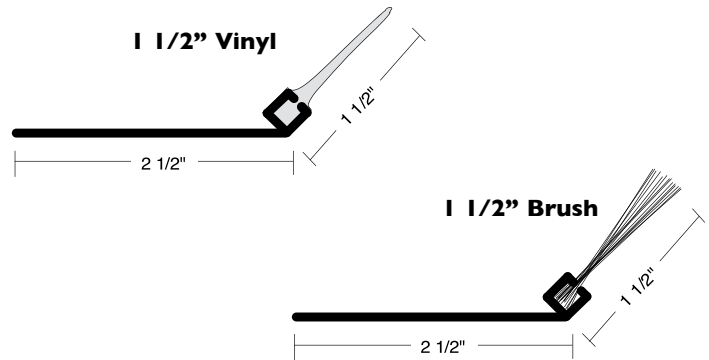

Style 25 - JUMBO SEAL - 2" Vinyl or Brush

Stock	Description
I43890	Style 25 10' JUMBO SEAL with 2" Vinyl - 10 pcs
I43891	Style 25 12' JUMBO SEAL with 2" Vinyl - 10 pcs
I43892	Style 25 14' JUMBO SEAL with 2" Vinyl - 10 pcs
I43893	Style 25 16' JUMBO SEAL with 2" Vinyl - 10 pcs
I43920	Style 25 10' JUMBO SEAL with 2" Brush - 10 pcs
I43921	Style 25 12' JUMBO SEAL with 2" Brush - 10 pcs
I43922	Style 25 14' JUMBO SEAL with 2" Brush - 10 pcs
I43923	Style 25 16' JUMBO SEAL with 2" Brush - 10 pcs

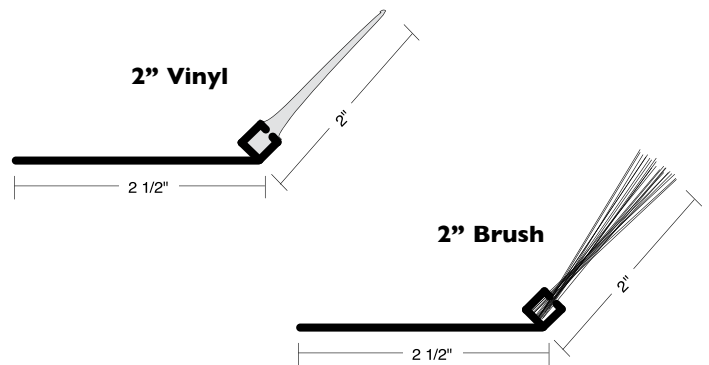

Style 25 - JUMBO SEAL - 3" Vinyl or Brush

Stock	Description
I43900	Style 25 10' JUMBO SEAL with 3" Vinyl - 10 pcs
I43901	Style 25 12' JUMBO SEAL with 3" Vinyl - 10 pcs
I43902	Style 25 14' JUMBO SEAL with 3" Vinyl - 10 pcs
I43903	Style 25 16' JUMBO SEAL with 3" Vinyl - 10 pcs
I43930	Style 25 10' JUMBO SEAL with 3" Brush - 10 pcs
I43931	Style 25 12' JUMBO SEAL with 3" Brush - 10 pcs
I43932	Style 25 14' JUMBO SEAL with 3" Brush - 10 pcs
I43933	Style 25 16' JUMBO SEAL with 3" Brush - 10 pcs

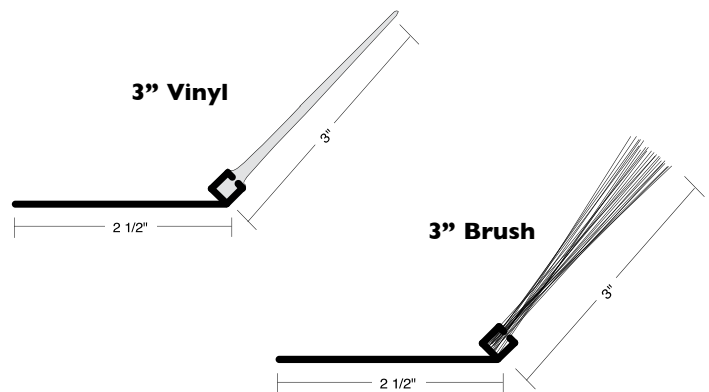

Vinyl and brush Jumbo Seal is food grade

Style 35 - JUMBO SEAL - 1 1/2" Vinyl or Brush

- 3 1/2" 45° aluminum retainer
- Heavy aluminum extrusion with vinyl or brush
- Sold in full cartons only

Stock	Description
I43940	Style 35 10' JUMBO SEAL with 1 1/2" Vinyl - 10 pcs
I43941	Style 35 12' JUMBO SEAL with 1 1/2" Vinyl - 10 pcs
I43942	Style 35 14' JUMBO SEAL with 1 1/2" Vinyl - 10 pcs
I43943	Style 35 16' JUMBO SEAL with 1 1/2" Vinyl - 10 pcs
I43970	Style 35 10' JUMBO SEAL with 1 1/2" Brush - 10 pcs
I43971	Style 35 12' JUMBO SEAL with 1 1/2" Brush - 10 pcs
I43972	Style 35 14' JUMBO SEAL with 1 1/2" Brush - 10 pcs
I43973	Style 35 16' JUMBO SEAL with 1 1/2" Brush - 10 pcs

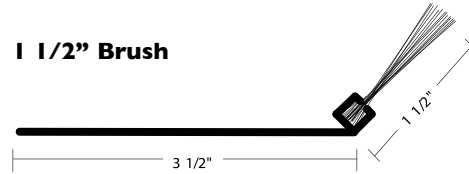
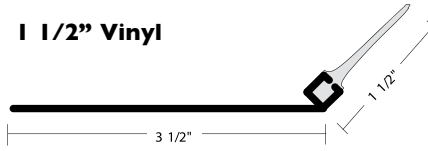

Style 35 - JUMBO SEAL - 2" Vinyl or Brush

Stock	Description
I43950	Style 35 10' JUMBO SEAL with 2" Vinyl - 10 pcs
I43951	Style 35 12' JUMBO SEAL with 2" Vinyl - 10 pcs
I43952	Style 35 14' JUMBO SEAL with 2" Vinyl - 10 pcs
I43953	Style 35 16' JUMBO SEAL with 2" Vinyl - 10 pcs
I43980	Style 35 10' JUMBO SEAL with 2" Brush - 10 pcs
I43981	Style 35 12' JUMBO SEAL with 2" Brush - 10 pcs
I43982	Style 35 14' JUMBO SEAL with 2" Brush - 10 pcs
I43983	Style 35 16' JUMBO SEAL with 2" Brush - 10 pcs

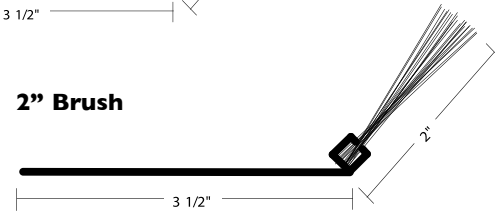
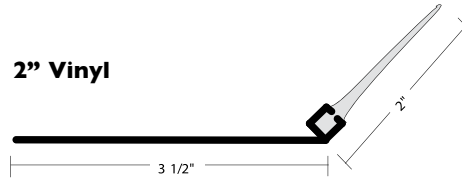

Style 35 - JUMBO SEAL - 3" Vinyl or Brush

Stock	Description
I43960	Style 35 10' JUMBO SEAL with 3" Vinyl - 10 pcs
I43961	Style 35 12' JUMBO SEAL with 3" Vinyl - 10 pcs
I43962	Style 35 14' JUMBO SEAL with 3" Vinyl - 10 pcs
I43963	Style 35 16' JUMBO SEAL with 3" Vinyl - 10 pcs
I43990	Style 35 10' JUMBO SEAL with 3" Brush - 10 pcs
I43991	Style 35 12' JUMBO SEAL with 3" Brush - 10 pcs
I43992	Style 35 14' JUMBO SEAL with 3" Brush - 10 pcs
I43993	Style 35 16' JUMBO SEAL with 3" Brush - 10 pcs

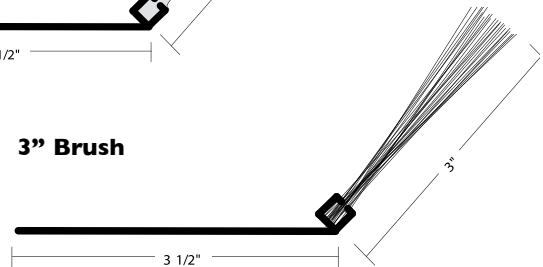
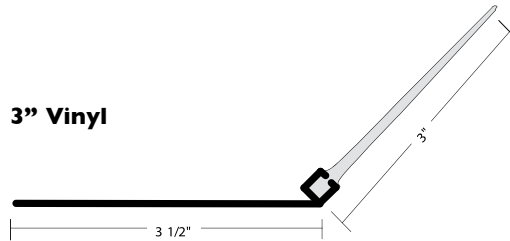

Vinyl and brush Jumbo Seal is food grade

Style NI50 - JUMBO SEAL - 1 1/2" Vinyl or Brush

- 1 1/2" 90° aluminum retainer
- Heavy aluminum extrusion with vinyl or brush
- Sold as full cartons only

Stock	Description
I42700	Style NI50 10' JUMBO SEAL with 1 1/2" Vinyl - 10 pcs
I42701	Style NI50 12' JUMBO SEAL with 1 1/2" Vinyl - 10 pcs
I42702	Style NI50 14' JUMBO SEAL with 1 1/2" Vinyl - 10 pcs
I42703	Style NI50 16' JUMBO SEAL with 1 1/2" Vinyl - 10 pcs
I42715	Style NI50 10' JUMBO SEAL with 1 1/2" Brush - 10 pcs
I42716	Style NI50 12' JUMBO SEAL with 1 1/2" Brush - 10 pcs
I42717	Style NI50 14' JUMBO SEAL with 1 1/2" Brush - 10 pcs
I42718	Style NI50 16' JUMBO SEAL with 1 1/2" Brush - 10 pcs

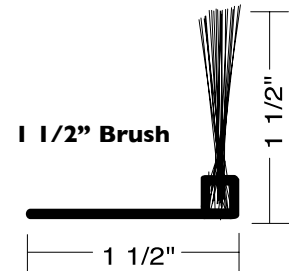
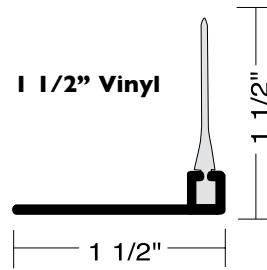

Style NI50 - JUMBO SEAL - 2" Vinyl or Brush

Stock	Description
I42705	Style NI50 10' JUMBO SEAL with 2" Vinyl - 10 pcs
I42706	Style NI50 12' JUMBO SEAL with 2" Vinyl - 10 pcs
I42707	Style NI50 14' JUMBO SEAL with 2" Vinyl - 10 pcs
I42708	Style NI50 16' JUMBO SEAL with 2" Vinyl - 10 pcs
I42720	Style NI50 10' JUMBO SEAL with 2" Brush - 10 pcs
I42721	Style NI50 12' JUMBO SEAL with 2" Brush - 10 pcs
I42722	Style NI50 14' JUMBO SEAL with 2" Brush - 10 pcs
I42723	Style NI50 16' JUMBO SEAL with 2" Brush - 10 pcs

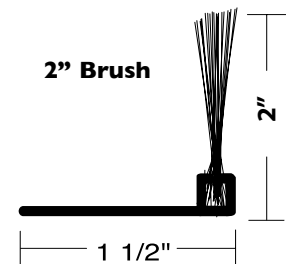
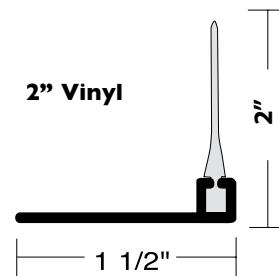

Style NI50 - JUMBO SEAL - 3" Vinyl or Brush

Stock	Description
I42710	Style NI50 10' JUMBO SEAL with 3" Vinyl - 10 pcs
I42711	Style NI50 12' JUMBO SEAL with 3" Vinyl - 10 pcs
I42712	Style NI50 14' JUMBO SEAL with 3" Vinyl - 10 pcs
I42713	Style NI50 16' JUMBO SEAL with 3" Vinyl - 10 pcs
I42725	Style NI50 10' JUMBO SEAL with 3" Brush - 10 pcs
I42726	Style NI50 12' JUMBO SEAL with 3" Brush - 10 pcs
I42727	Style NI50 14' JUMBO SEAL with 3" Brush - 10 pcs
I42728	Style NI50 16' JUMBO SEAL with 3" Brush - 10 pcs

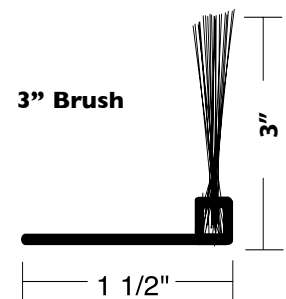
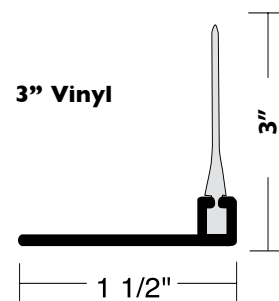

Vinyl and brush Jumbo Seal is food grade

Style S150 - JUMBO SEAL - 1 1/2" Vinyl or Brush

- 1 1/2" Straight aluminum retainer
- Heavy aluminum extrusion with vinyl or brush
- Sold in full cartons only

Stock	Description
I42600	Style S150 10' JUMBO SEAL with 1 1/2" Vinyl - 10 pcs
I42601	Style S150 12' JUMBO SEAL with 1 1/2" Vinyl - 10 pcs
I42602	Style S150 14' JUMBO SEAL with 1 1/2" Vinyl - 10 pcs
I42603	Style S150 16' JUMBO SEAL with 1 1/2" Vinyl - 10 pcs
I42615	Style S150 10' JUMBO SEAL with 1 1/2" Brush - 10 pcs
I42616	Style S150 12' JUMBO SEAL with 1 1/2" Brush - 10 pcs
I42617	Style S150 14' JUMBO SEAL with 1 1/2" Brush - 10 pcs
I42618	Style S150 16' JUMBO SEAL with 1 1/2" Brush - 10 pcs

1 1/2" Vinyl

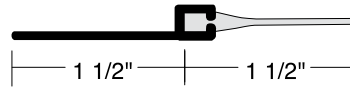

1 1/2" Brush



Style S150 - JUMBO SEAL - 2" Vinyl or Brush

Stock	Description
I42605	Style S150 10' JUMBO SEAL with 2" Vinyl - 10 pcs
I42606	Style S150 12' JUMBO SEAL with 2" Vinyl - 10 pcs
I42607	Style S150 14' JUMBO SEAL with 2" Vinyl - 10 pcs
I42608	Style S150 16' JUMBO SEAL with 2" Vinyl - 10 pcs
I42620	Style S150 10' JUMBO SEAL with 2" Brush - 10 pcs
I42621	Style S150 12' JUMBO SEAL with 2" Brush - 10 pcs
I42622	Style S150 14' JUMBO SEAL with 2" Brush - 10 pcs
I42623	Style S150 16' JUMBO SEAL with 2" Brush - 10 pcs

2" Vinyl

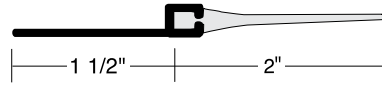

2" Brush

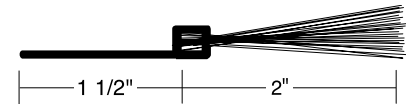

Style S150 - JUMBO SEAL - 3" Vinyl or Brush

Stock	Description
I42610	Style S150 10' JUMBO SEAL with 3" Vinyl - 10 pcs
I42611	Style S150 12' JUMBO SEAL with 3" Vinyl - 10 pcs
I42612	Style S150 14' JUMBO SEAL with 3" Vinyl - 10 pcs
I42613	Style S150 16' JUMBO SEAL with 3" Vinyl - 10 pcs
I42625	Style S150 10' JUMBO SEAL with 3" Brush - 10 pcs
I42626	Style S150 12' JUMBO SEAL with 3" Brush - 10 pcs
I42627	Style S150 14' JUMBO SEAL with 3" Brush - 10 pcs
I42628	Style S150 16' JUMBO SEAL with 3" Brush - 10 pcs

3" Vinyl

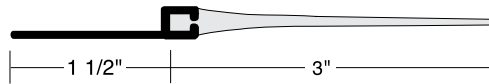

3" Brush

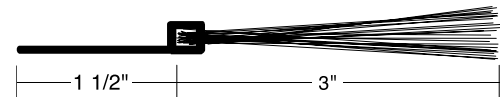

Style S250 - JUMBO SEAL - 1 1/2" Vinyl or Brush

- 2 1/2" Straight aluminum retainer
- Heavy aluminum extrusion with vinyl or brush
- Sold in full cartons only

Stock	Description
I42630	Style S250 10' JUMBO SEAL with 1 1/2" Vinyl - 10 pcs
I42631	Style S250 12' JUMBO SEAL with 1 1/2" Vinyl - 10 pcs
I42632	Style S250 14' JUMBO SEAL with 1 1/2" Vinyl - 10 pcs
I42633	Style S250 16' JUMBO SEAL with 1 1/2" Vinyl - 10 pcs
I42645	Style S250 10' JUMBO SEAL with 1 1/2" Brush - 10 pcs
I42646	Style S250 12' JUMBO SEAL with 1 1/2" Brush - 10 pcs
I42647	Style S250 14' JUMBO SEAL with 1 1/2" Brush - 10 pcs
I42648	Style S250 16' JUMBO SEAL with 1 1/2" Brush - 10 pcs

1 1/2" Vinyl

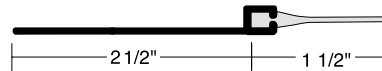

1 1/2" Brush



Vinyl and brush Jumbo Seal is food grade

Direct Dial: (817) 834-7300

Style S250 - JUMBO SEAL - 2" Vinyl or Brush

Stock	Description
I42635	Style S250 10' JUMBO SEAL with 2" Vinyl - 10 pcs
I42636	Style S250 12' JUMBO SEAL with 2" Vinyl - 10 pcs
I42637	Style S250 14' JUMBO SEAL with 2" Vinyl - 10 pcs
I42638	Style S250 16' JUMBO SEAL with 2" Vinyl - 10 pcs
I42650	Style S250 10' JUMBO SEAL with 2" Brush - 10 pcs
I42651	Style S250 12' JUMBO SEAL with 2" Brush - 10 pcs
I42652	Style S250 14' JUMBO SEAL with 2" Brush - 10 pcs
I42653	Style S250 16' JUMBO SEAL with 2" Brush - 10 pcs

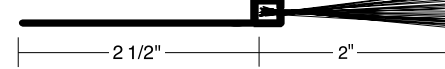
2" Vinyl**2" Brush****Style S250 - JUMBO SEAL - 3" Vinyl or Brush**

Stock	Description
I42640	Style S250 10' JUMBO SEAL with 3" Vinyl - 10 pcs
I42641	Style S250 12' JUMBO SEAL with 3" Vinyl - 10 pcs
I42642	Style S250 14' JUMBO SEAL with 3" Vinyl - 10 pcs
I42643	Style S250 16' JUMBO SEAL with 3" Vinyl - 10 pcs
I42655	Style S250 10' JUMBO SEAL with 3" Brush - 10 pcs
I42656	Style S250 12' JUMBO SEAL with 3" Brush - 10 pcs
I42657	Style S250 14' JUMBO SEAL with 3" Brush - 10 pcs
I42658	Style S250 16' JUMBO SEAL with 3" Brush - 10 pcs

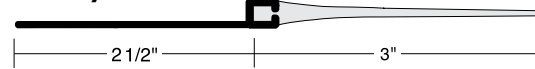
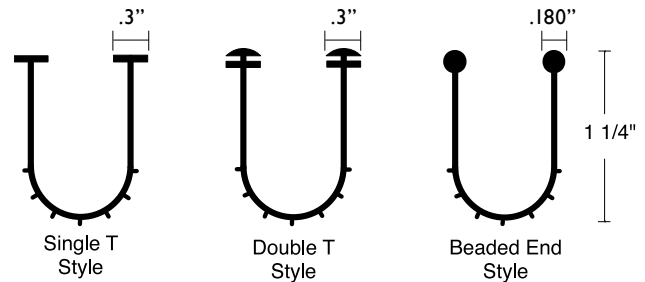
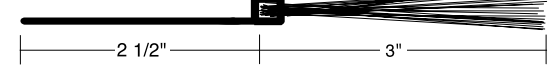
3" Vinyl**3" Brush****Vinyl Bottom Seal Inserts**

- Provides better conformity to irregular floor situations.
- Stays flexible below zero° degrees
- Seals against snow, water, dirt and wind
- Mount to door using the Aluminum Weatherseal Retainers or the Adjustable Bottom Rails
- Available in rolls or 20 foot cut to length increments
- Flexible PVC
- 3" Single T will only work with PWSR Retainers
- Bulk Boxes

Stock	Description
I41000	3" Single T Vinyl Insert - Black - 300' Roll
I41004	3" Single T Vinyl Insert - Grey - 300' Roll
I41100	3 1/2" Single T Vinyl Insert - Black - 300' Roll
I41102	3 1/2" Single T Vinyl Insert - Brown - 300' Roll
I41104	3 1/2" Single T Vinyl Insert - Grey - 300' Roll
I41124	3 1/2" Double T Vinyl Insert - Grey - 300' Roll
I41144	3 1/2" Beaded End Vinyl Insert - Grey - 300' Roll
I41200	5 1/2" Single T Vinyl Bottom Seal - Black - 200' Roll
I41202	5 1/2" Single T Vinyl Bottom Seal - Brown - 200' Roll
I41204	5 1/2" Single T Vinyl Bottom Seal - Grey - 200' Roll
I41300	7" Single T Vinyl Bottom Seal - Black - 200' Roll
I41302	7" Single T Vinyl Bottom Seal - Brown - 200' Roll
I41304	7" Single T Vinyl Bottom Seal - Grey - 200' Roll
I41332	7" Beaded End Vinyl Bottom Seal - Grey - 200' Roll

Vinyl and brush Jumbo Seal is food grade

100 ft Rolls

Stock	Description
I41000-100	3" Single T Vinyl Insert - Black - 100' Roll
I41004-100	3" Single T Vinyl Insert - Grey - 100' Roll
I41100-100	3 1/2" Single T Vinyl Bottom Seal - Black - 100' Roll
I41102-100	3 1/2" Single T Vinyl Bottom Seal - Brown - 100' Roll
I41104-100	3 1/2" Single T Vinyl Bottom Seal - Grey - 100' Roll
I41124-100	3 1/2" Double T Vinyl Bottom Seal - Grey - 100' Roll
I41144-100	3 1/2" Beaded End Vinyl Bottom Seal - Grey - 100' Roll
I41200-100	5 1/2" Single T Vinyl Bottom Seal - Black - 100' Roll
I41202-100	5 1/2" Single T Vinyl Bottom Seal - Brown - 100' Roll
I41204-100	5 1/2" Single T Vinyl Bottom Seal - Grey - 100' Roll
I41300-100	7" Single T Vinyl Bottom Seal - Black - 100' Roll
I41302-100	7" Single T Vinyl Bottom Seal - Brown - 100' Roll
I41304-100	7" Single T Vinyl Bottom Seal - Grey - 100' Roll

Cut to Length - 20 foot minimum

Stock	Description
I41460	3 1/2" Single T Vinyl Cut to Length - Grey
I41470	5 1/2" Single T Vinyl Cut to Length - Grey
I41480	7" Single T Vinyl Cut to Length - Grey
I41464	3 1/2" Double T Vinyl cut to Length - Grey
I41466	3 1/2" Beaded End Vinyl Cut to Length - Grey

Email: sales@natdoor.com

POLAR Jamb Seal

Stock	Description
I43300	10' Polar Jamb Seal - 1 1/2" Retainer - 10 pcs
I43301	12' Polar Jamb Seal - 1 1/2" Retainer - 10 pcs
I43302	14' Polar Jamb Seal - 1 1/2" Retainer - 10 pcs
I43303	16' Polar Jamb Seal - 1 1/2" Retainer - 10 pcs
I43310	10' Polar Jamb Seal - 2 1/2" Retainer - 10 pcs
I43311	12' Polar Jamb Seal - 2 1/2" Retainer - 10 pcs
I43312	14' Polar Jamb Seal - 2 1/2" Retainer - 10 pcs
I43313	16' Polar Jamb Seal - 2 1/2" Retainer - 10 pcs
I43320	10' Polar Jamb Seal - 3 1/2" Retainer - 10 pcs
I43321	12' Polar Jamb Seal - 3 1/2" Retainer - 10 pcs
I43322	14' Polar Jamb Seal - 3 1/2" Retainer - 10 pcs
I43323	16' Polar Jamb Seal - 3 1/2" Retainer - 10 pcs

STAYS FLEXIBLE TO -40° F

- Mill finish aluminum
- Stays flexible and pliable in colder temperatures
- Easy installation to any jamb by mechanical or adhesive fastening
- Available in 10, 12, 14 and 16 foot lengths
- Retainers available in 1 1/2", 2 1/2" or 3 1/2"
- 1 1/2" Polar White Vinyl

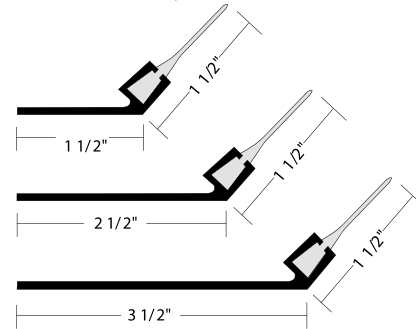

Vinyl Guide Seal

Stock	Description
I44280	1 1/2" x 10' Vinyl Guide Seal - 10 pcs
I44281	1 1/2" x 12' Vinyl Guide Seal - 10 pcs
I44282	1 1/2" x 14' Vinyl Guide Seal - 10 pcs
I44283	1 1/2" x 16' Vinyl Guide Seal - 10 pcs
I44290	2" x 10' Vinyl Guide Seal - 10 pcs
I44291	2" x 12' Vinyl Guide Seal - 10 pcs
I44292	2" x 14' Vinyl Guide Seal - 10 pcs
I44293	2" x 16' Vinyl Guide Seal - 10 pcs
I44300	3" x 10' Vinyl Guide Seal - 10 pcs
I44301	3" x 12' Vinyl Guide Seal - 10 pcs
I44302	3" x 14' Vinyl Guide Seal - 10 pcs
I44303	3" x 16' Vinyl Guide Seal - 10 pcs

- Use as vinyl perimeter seal on rolling steel or curtain doors
- Use as bottom seal on curtain doors with double or single angle bottom rails
- Will fit guides to 1/4" thick
- 3 vinyl widths: 1 1/2", 2" and 3"
- Available in 10, 12, 14 and 16 foot lengths
- Plastic retainer with grey vinyl

Side Seal Application

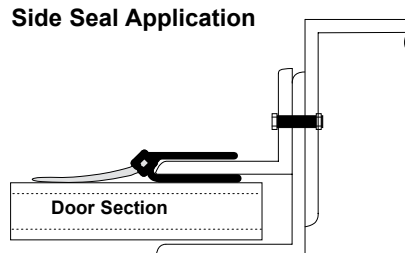

Bottom Seal Application

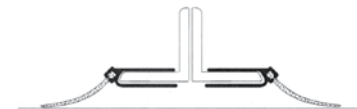

Brush Guide Seal

Stock	Description
I44310	1 1/2" x 10' Brush Guide Seal - 10 pcs
I44311	1 1/2" x 12' Brush Guide Seal - 10 pcs
I44312	1 1/2" x 14' Brush Guide Seal - 10 pcs
I44313	1 1/2" x 16' Brush Guide Seal - 10 pcs
I44320	2" x 10' Brush Guide Seal - 10 pcs
I44321	2" x 12' Brush Guide Seal - 10 pcs
I44322	2" x 14' Brush Guide Seal - 10 pcs
I44323	2" x 16' Brush Guide Seal - 10 pcs
I44330	3" x 10' Brush Guide Seal - 10 pcs
I44331	3" x 12' Brush Guide Seal - 10 pcs
I44332	3" x 14' Brush Guide Seal - 10 pcs
I44333	3" x 16' Brush Guide Seal - 10 pcs

- Use as brush perimeter seal on rolling steel or curtain doors
- Use as bottom seal on curtain doors with double or single angle bottom rails
- Will fit guides to 1/4" thick
- 3 brush widths: 1 1/2", 2" and 3"
- Available in 10, 12, 14 and 16 foot lengths
- Plastic retainer with black brush

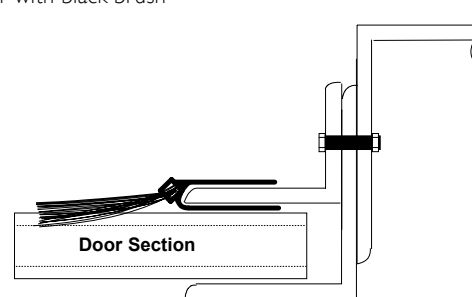

Direct Dial: (817) 834-7300

Polar Stop Vinyl (TPR)

- Stays flexible and pliable down to -65° F
- Tested in Alaska
- Made from thermoplastic rubber (TPR)
- Insures a good tight seal regardless of how cold it gets

Stock	Description
I43000	750' Polar Stop Mold Vinyl - Tan

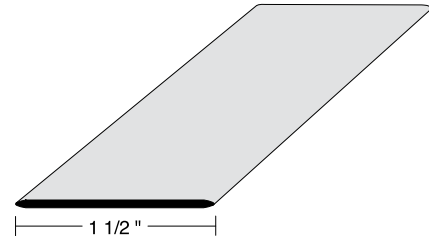

Reversible Stop Mold Vinyl

- Cut a saw kerf in any type of wood and press the vinyl in for a custom look
- 1/8" wide, 1/4" deep kerf

Stock	Description
I42010	500' Roll Reversible Stop Mold Vinyl - White
I42011	500' Roll Reversible Stop Mold Vinyl - Brown
I42014	500' Roll Reversible Stop Mold Vinyl - Almond
I42016	500' Roll Reversible Stop Mold Vinyl - Grey
I42018	500' Roll Reversible Stop Mold Vinyl - Tan
I42019	500' Roll Reversible Stop Mold Vinyl - Black

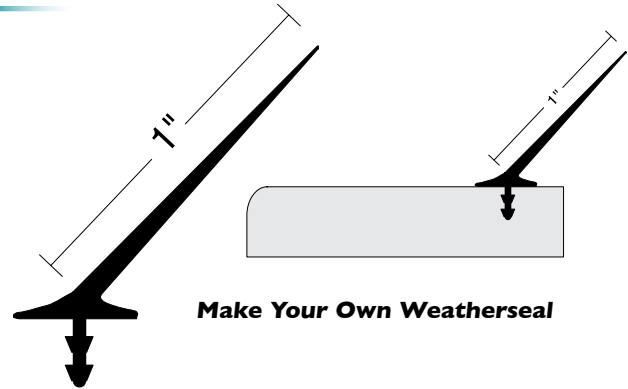

Stop Mold Vinyl

Standard Smooth Surface

- For use in Wood Stop Mold
- Less than 1/16" thick

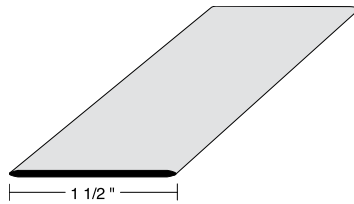

Stock	Description
I43001	1 1/2" x 750' Stop Mold Vinyl - White
I43002	1 1/2" x 750' Stop Mold Vinyl - Brown
I43003	1 1/2" x 750' Stop Mold Vinyl - Grey
I43004	1 1/2" x 750' Stop Mold Vinyl - Tan
I43005	1 1/2" x 750' Stop Mold Vinyl - Black

Ribbed Surface

- For use in Wood Stop Mold

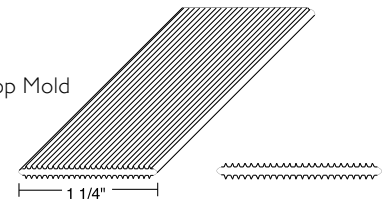

Stock	Description
I43010	1 1/4" x 1000' Ribbed Stop Mold Vinyl - White
I43011	1 1/4" x 1000' Ribbed Stop Mold Vinyl - Brown
I43012	1 1/4" x 1000' Ribbed Stop Mold Vinyl - Grey
I43013	1 1/4" x 1000' Ribbed Stop Mold Vinyl - Tan
I43014	1 1/4" x 1000' Ribbed Stop Mold Vinyl - Almond
I43015	1 1/4" x 1000' Ribbed Stop Mold Vinyl - Desert Tan
I43016	1 1/4" x 1000' Ribbed Stop Mold Vinyl - Sandstone
I43017	1 1/4" x 1000' Ribbed Stop Mold Vinyl - Black

Wood Door Rubber Astragal

- Constructed from quality EPDM material
- Expanded to give an excellent seal on uneven floors
- Black foam or sponge texture
- Tough exterior surface to give years of trouble free service
- Stays flexible in temperatures ranging from -40° F to +200° F
- Available in 2 100' rolls

Stock	Description
I40200	1 3/8" EPDM Door Seal Astragal - 200'
I40300	1 3/4" EPDM Door Seal Astragal - 200'

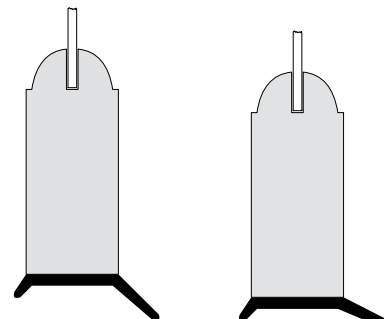

Door Header Seal

Stock	Description
140655	3" x 100' Roll Vinyl Header Seal - Grey - 100' Roll
140656	3" Vinyl Header Seal - Grey - Cut to Length

- Positive seal on the top of the door
- Seals gaps up to 2 1/2"
- Slides into our standard Aluminum Weatherseal Retainer only
- Most economical
- Keeps the wind out
- Will not work with PWSR Retainer

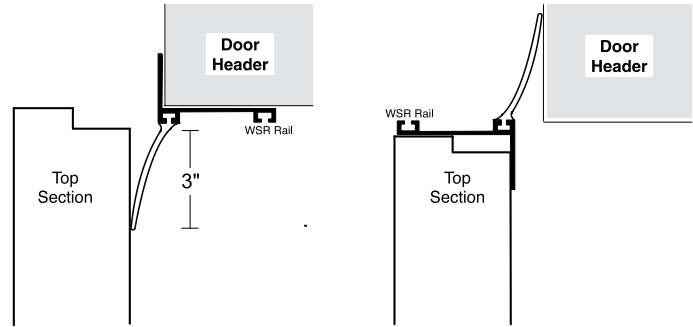

POLAR Bottom Seal

Stock	Description
141112	3 1/2" POLAR Bottom Seal - Single T - 300' Roll
141112-100	3 1/2" POLAR Bottom Seal - Single T - 100' Roll
141133	3 1/2" POLAR Bottom Seal - Double T - 300' Roll
141133-100	3 1/2" POLAR Bottom Seal - Double T - 100' Roll
141153	3 1/2" POLAR Bottom Seal - Beaded End - 300' Roll
141153-100	3 1/2" POLAR Bottom Seal - Beaded End - 100' Roll
141453	3 1/2" POLAR Single T Bottom Seal - Cut to Length
141454	3 1/2" POLAR Double T Bottom Seal - Cut to Length
141455	3 1/2" POLAR Beaded End Bottom Seal - Cut to Length

For sub-zero temperatures

- Stays flexible and pliable to -40° F
- Made from Thermoplastic Elastomer (TPE)
- Adjusts to uneven floors
- Three styles: Single T, Double T and Beaded End
- Available in grey only

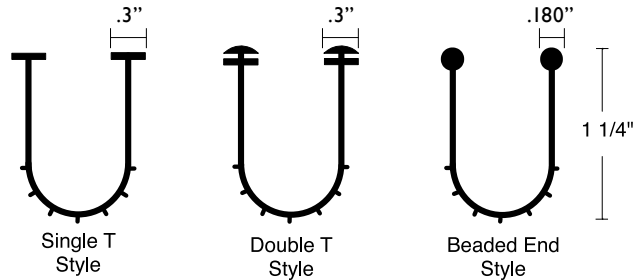

Reverse Angle Weatherseal

- The easiest and least expensive weatherstrip to install
- Slips over angle. No tools, no fasteners
- Fits all manufacturers standard reverse angle track

Straight Lengths - Regular & Heavy Duty

- The heavy duty is a two piece product where the vinyl piece slides into the rigid
- Regular straight pieces are a co-extruded 1 piece weatherseal just like the rolled material
- Straight length pieces available in 10, 12, 14, and 16 foot lengths (light grey only), in 2 styles - Regular and Heavy Duty
- Not shippable by UPS

Rolled - Regular Duty

- 2-100 foot rolls per carton are available in white, grey, chocolate brown, black, almond and sandstone
- Will ship via UPS

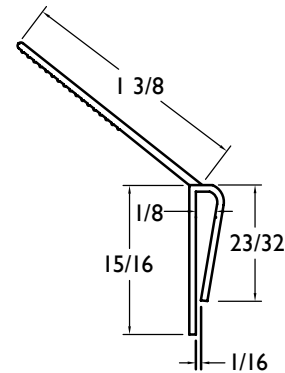

Rolled

Stock	Description
143790	Reverse Angle Weatherseal - White - 200' Roll
143791	Reverse Angle Weatherseal - Grey - 200' Roll
143792	Reverse Angle Weatherseal - Chocolate Brown - 200' Roll
143793	Reverse Angle Weatherseal - Black - 200' Roll
143794	Reverse Angle Weatherseal - Almond - 200' Roll
143795	Reverse Angle Weatherseal - Sandstone - 200' Roll

Straight Lengths

Stock	Description
143760	10' Reverse Angle Weatherseal - Heavy Duty - 25 pcs
143770	12' Reverse Angle Weatherseal - Heavy Duty - 25 pcs
143780	14' Reverse Angle Weatherseal - Heavy Duty - 25 pcs
143781	16' Reverse Angle Weatherseal - Heavy Duty - 25 pcs
143785	10' Reverse Angle Weatherseal - Regular Duty - 25 pcs
143786	12' Reverse Angle Weatherseal - Regular Duty - 25 pcs
143787	14' Reverse Angle Weatherseal - Regular Duty - 25 pcs
143788	16' Reverse Angle Weatherseal - Regular Duty - 25 pcs

Direct Dial: (817) 834-7300

Adjustable Bottom Rails

1 3/8" x 3" Adjustable Bottom Rail

- For 1 3/8" thick doors, 3" depth
- Covers gap to 2 1/2"
- Vinyl weatherseal seals the door to the floor
- Aluminium

Stock	Description
I47003	1 3/8" x 3" x 8' Adjustable Bottom Rail - 2 pcs
I47013	1 3/8" x 3" x 16' Adjustable Bottom Rail - 2 pcs
I47015	1 3/8" x 3" x 18' Adjustable Bottom Rail - 2 pcs

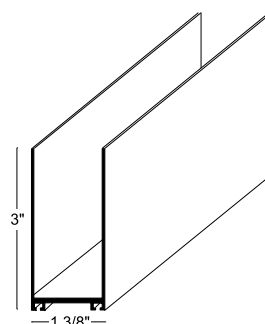

2" x 2" Adjustable Bottom Rail

- For 2" thick doors
- 2" depth
- Covers gaps to 1 1/2 inches
- Vinyl weatherseal seals the door to the floor
- Aluminium

Stock	Description
I47104	2" x 2" x 8' 2" Adjustable Bottom Rail - 2 pcs
I47108	2" x 2" x 10' 2" Adjustable Bottom Rail - 2 pcs
I47110	2" x 2" x 12' 2" Adjustable Bottom Rail - 2 pcs
I47112	2" x 2" x 14' 2" Adjustable Bottom Rail - 2 pcs
I47114	2" x 2" x 16' 2" Adjustable Bottom Rail - 2 pcs
I47116	2" x 2" x 18' 2" Adjustable Bottom Rail - 2 pcs

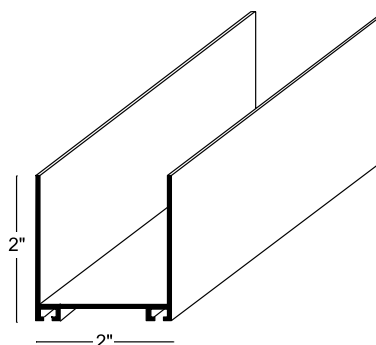

2" x 3" Adjustable Bottom Rail

- Vinyl weatherseal seals the door to the floor
- Covers gaps to 2 1/2"
- For 2" thick doors
- 3" depth
- Aluminium

Stock	Description
I47124	2" x 3" x 8' 2" Adjustable Bottom Rail - 2 pcs
I47128	2" x 3" x 10' 2" Adjustable Bottom Rail - 2 pcs
I47130	2" x 3" x 12' 2" Adjustable Bottom Rail - 2 pcs
I47132	2" x 3" x 14' 2" Adjustable Bottom Rail - 2 pcs
I47134	2" x 3" x 16' 2" Adjustable Bottom Rail - 2 pcs
I47136	2" x 3" x 18' 2" Adjustable Bottom Rail - 2 pcs

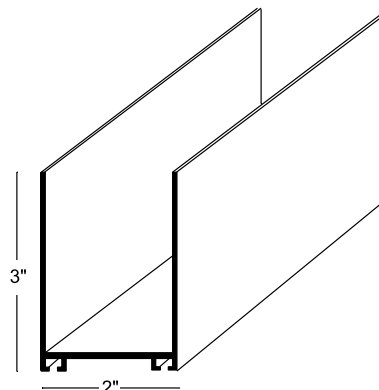

Deep Adjustable Bottom Rail - For 2" Doors Only

- National Door's deep channel adjustable bottom rail offers you a solution to uneven flooring
- Use the connector strip to join lengths over 10 feet
- Attach our Aluminum Weatherseal Retainer Rail and vinyl T to the bottom for a complete seal
- 6" covers gaps to 5"
- 8" covers gaps to 7"
- Stack for more coverage
- Galvanized sheet metal 18 gauge

Stock	Description
I47142	2" x 6" x 10' Deep Adjustable Bottom Rail - 2 pcs
I47143	2" x 8" x 10' Deep Adjustable Bottom Rail - 2 pcs
I47141	2" x 5" x 12' Connector Strip for Deep Adjustable Bottom Rails

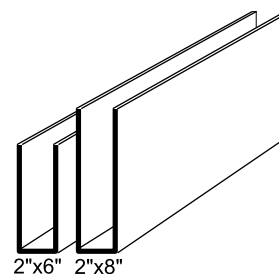

Email: sales@natdoor.com

Aluminum Weatherseal Retainer

Aluminum Weatherseal Retainer Rails (AWSR)

Aluminum Weatherseal Retainer used as bottom retainers on ship lap or tongue & groove doors

- Use with our 3 1/2" Single T vinyl for 1" of compression
- Use with our 5 1/2" Single T vinyl for 2 1/4" of compression
- Use with our 7" Single T vinyl for 3" of compression
- Install with self drilling Tek Screws, nails or rivets
- 1 3/8" width for residential doors
- 2" width for commercial doors

Low Profile Aluminum Weatherseal Retainer Rail

- Rail is a lighter weight for 2" tongue & groove doors

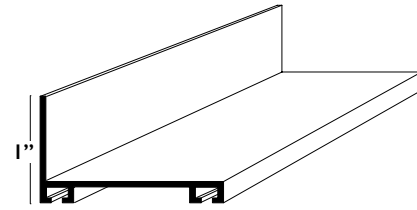

Flat Style

Flat Retainer

Stock	Description
I48003	8' x 1 3/8" Flat Retainer - 4 pcs
I48005	9' x 1 3/8" Flat Retainer - 4 pcs
I48013	16' x 1 3/8" Flat Retainer- 4 pcs
I48015	18' x 1 3/8" Flat Retainer- 4 pcs
I48104	8' 2" x 2" Flat Retainer- 4 pcs
I48108	10' 2" x 2" Flat Retainer- 4 pcs
I48110	12' 2" x 2" Flat Retainer- 4 pcs
I48112	14' 2" x 2" Flat Retainer- 4 pcs
I48114	16' 2" x 2" Flat Retainer- 4 pcs
I48116	18' 2" x 2" Flat Retainer- 4 pcs

2 inch - Low Profile Retainer

Stock	Description
I48204	8' 2" x 2" Low Profile Retainer - 10 pcs
I48208	10' 2" x 2" Low Profile Retainer - 10 pcs
I48210	12' 2" x 2" Low Profile Retainer - 10 pcs
I48212	14' 2" x 2" Low Profile Retainer - 10 pcs
I48214	16' 2" x 2" Low Profile Retainer - 10 pcs
I48216	18' 2" x 2" Low Profile Retainer - 10 pcs

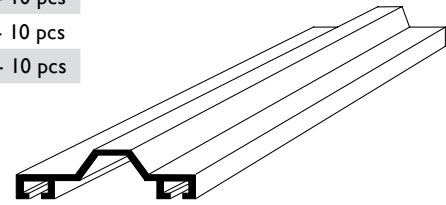

Low Profile Style

Plastic Weatherseal Retainer

Plastic Weatherseal Retainer Rails (PWSR)

- Plastic Weatherstrip Retainer used as bottom rail on 2" doors
- Style F has a flat bottom for wood or steel doors, packed 20 pieces per carton
- Style T is for Tongue & Grooved doors, packed 20 pieces per carton
- Use with our 3 1/2" Single T Vinyl for 1" of compression
- Use with our 5 1/2" Single T Vinyl for 2 1/4" of compression
- Use with our 7" Single T vinyl for 3" of compression
- Install with self drilling Tek screws or rivets
- Available in black or white

Style F - Flat Retainer

Stock	Description
I49004	8' 2" Flat Style Retainer - White - 20 pcs
I49006	9' 2" Flat Style Retainer - White - 20 pcs
I49008	10' 2" Flat Style Retainer - White - 20 pcs
I49110	12' 2" Flat Style Retainer - White - 20 pcs
I49112	14' 2" Flat Style Retainer - White - 20 pcs
I49114	16' 2" Flat Style Retainer - White - 20 pcs
I49116	18' 2" Flat Style Retainer - White - 20 pcs
I49024	8' 2" Flat Style Retainer - Black - 20 pcs
I49026	9' 2" Flat Style Retainer - Black - 20 pcs
I49028	10' 2" Flat Style Retainer - Black - 20 pcs
I49030	12' 2" Flat Style Retainer - Black - 20 pcs
I49032	14' 2" Flat Style Retainer - Black - 20 pcs
I49034	16' 2" Flat Style Retainer - Black - 20 pcs
I49036	18' 2" Flat Style Retainer - Black - 20 pcs



Style F



Style T

Style T - Low Profile Style

Stock	Description
I49044	8' 2" Low Profile Style - White - 20 pcs
I49046	9' 2" Low Profile Style - White - 20 pcs
I49048	10' 2" Low Profile Style - White - 20 pcs
I49050	12' 2" Low Profile Style - White - 20 pcs
I49052	14' 2" Low Profile Style - White - 20 pcs
I49054	16' 2" Low Profile Style - White - 20 pcs
I49056	18' 2" Low Profile Style - White - 20 pcs
I49064	8' 2" Low Profile Style - Black - 20 pcs
I49066	9' 2" Low Profile Style - Black - 20 pcs
I49068	10' 2" Low Profile Style - Black - 20 pcs
I49070	12' 2" Low Profile Style - Black - 20 pcs
I49072	14' 2" Low Profile Style - Black - 20 pcs
I49074	16' 2" Low Profile Style - Black - 20 pcs
I49076	18' 2" Low Profile Style - Black - 20 pcs

Direct Dial: (817) 834-7300

Aluminum Bottom Weatherstrip Retainers

CLIP - INSTALL™
Patented

- Made from high strength aluminum
- Available in 2" lap sizes for commercial applications
- Uses any of our 3-1/2", 5-1/2", or 7" single T vinyl
- Install with self-drilling tek screws
- Saves money on shipping costs (UPS, FedEx, etc.)
- No excessive length shipping fees
- Reduces chance of freight damage

• Ships via UPS or FedEx •

Flat Bottom Weatherstrip Retainers

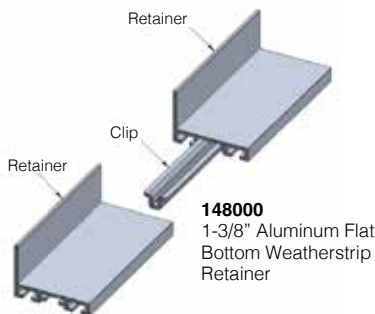

148000
1-3/8" Aluminum Flat Bottom Weatherstrip Retainer

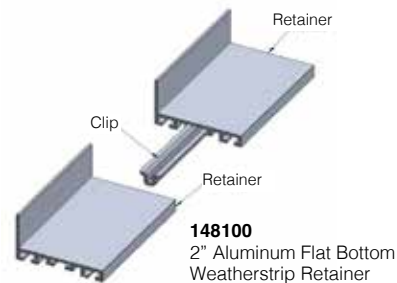

148100
2" Aluminum Flat Bottom Weatherstrip Retainer



148300
2" Aluminum Ez - Install Bottom Weatherstrip Retainer

Adjustable Bottom Rails

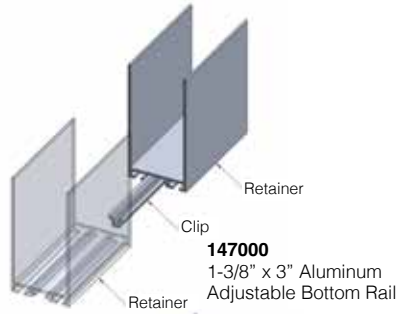

147000
1-3/8" x 3" Aluminum Adjustable Bottom Rail

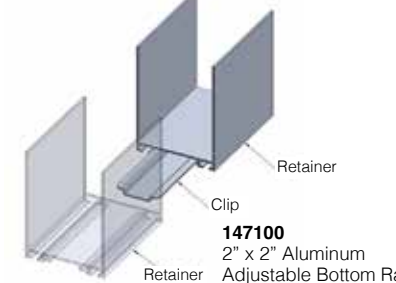

147100
2" x 2" Aluminum Adjustable Bottom Rail

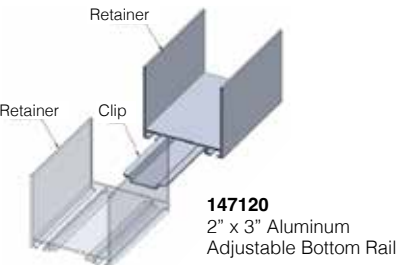

147120
2" x 3" Aluminum Adjustable Bottom Rail

Adapter Rails

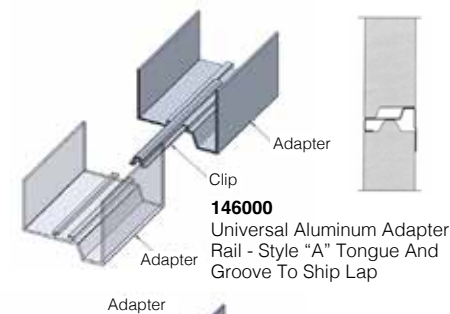

146000
Universal Aluminum Adapter Rail - Style "A" Tongue And Groove To Ship Lap

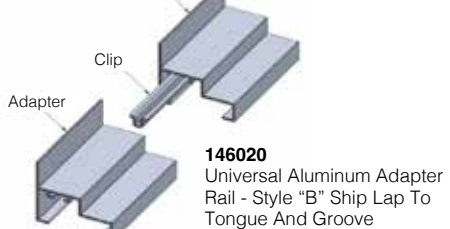

146020
Universal Aluminum Adapter Rail - Style "B" Ship Lap To Tongue And Groove

Low Profile Bottom Weatherstrip Retainer

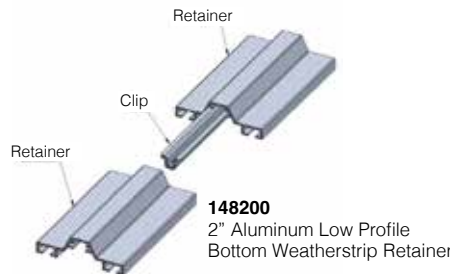

148200
2" Aluminum Low Profile Bottom Weatherstrip Retainer

Stock	Description
145900	SMALL Aluminum Extender Clip (25 pcs) for NDI Clip-Install products
145910	LARGE Aluminum Extender Clip for NDI Clip-Install products (25 pcs) (For 147100 & 147120 Only)
146000	UAR-040A Clip-Install Style A - 4ft Aluminum Universal Adapter Rail (8pcs/ctn)
146020	UAR-040B Clip-Install Style B - 4ft Aluminum Universal Adapter Rail (8pcs/ctn)
147000	ABR-138-040 Clip-Install 4ft x 1 3/8in x 3in Aluminum Adj Bottom Rail (4pcs/ctn)
147100	ABR-200-040 Clip-Install 4ft x 2in Aluminum Adj Bottom Rail (4pcs/ctn)
147120	ABR-200-040 Clip-Install 4ft x 3in Aluminum Adj Bottom Rail (4pcs/ctn)
148000	AWSR-138-040F Clip-Install 4ft x 1 3/8in - Aluminum Flat Retainer (8pcs/ctn)
148100	AWSR-200-040F Clip-Install 4ft x 2in - Aluminum Flat Retainer (8pcs/ctn)
148200	AWSR-200-040LP Clip-Install 4ft x 2in - Aluminum Low Profile Retainer (8pcs/ctn)
148300	AWSR-200-040EZ Clip-Install 4ft x 2in Aluminum EZ-Install Retainer (8pcs/ctn)

The Clip-Install product line is available in 4', 5', 6' length and 4'2", 5'2", 6'2" lengths.

- (-040) = 4'
- (-042) = 4' 2"
- (-050) = 5'
- (-052) = 5' 2"
- (-060) = 6'
- (-062) = 6' 2"

To specify length, append (-**) to stock number.
Example: 146000-052

Email: sales@natdoor.com



Universal Adapter Rail

- Adapts any manufacturer's section to another
- For 2" thick doors
- Style A adapts to ship lap
- Style B adapts to tongue and groove and is less visible on the exterior of the door

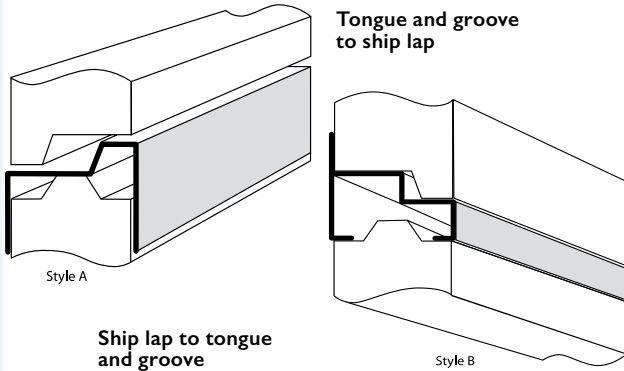

Stock	Description
I46004	8' 2" Aluminum Adapter Rail - Style A - 4 pcs
I46008	10' 2" Aluminum Adapter Rail - Style A - 4 pcs
I46010	12' 2" Aluminum Adapter Rail - Style A - 4 pcs
I46012	14' 2" Aluminum Adapter Rail - Style A - 4 pcs
I46014	16' 2" Aluminum Adapter Rail - Style A - 4 pcs
I46016	18' 2" Aluminum Adapter Rail - Style A - 4 pcs
I46024	8' 2" Aluminum Adapter Rail - Style B - 4 pcs
I46028	10' 2" Aluminum Adapter Rail - Style B - 4 pcs
I46030	12' 2" Aluminum Adapter Rail - Style B - 4 pcs
I46032	14' 2" Aluminum Adapter Rail - Style B - 4 pcs
I46034	16' 2" Aluminum Adapter Rail - Style B - 4 pcs
I46036	18' 2" Aluminum Adapter Rail - Style B - 4 pcs

Section Sealing Strips

- Foam tape for section joints
- Seals out wind and moisture
- Pressure sensitive, adhesive backed, sticks to any clean dry surface
- 3/8" wide

Stock	Description
I44400	3/16" x 17' - Section Seal Foam Tape
I44411	V-Flex Section Seal Strip White - 17' Roll

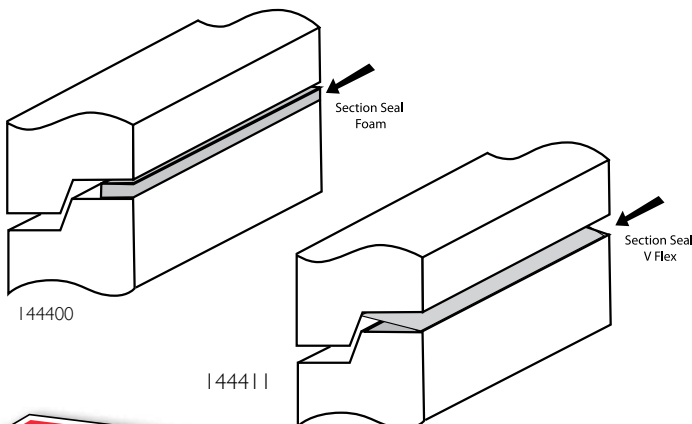

Backskin Retainers - Economy, Heavy Duty & Locking

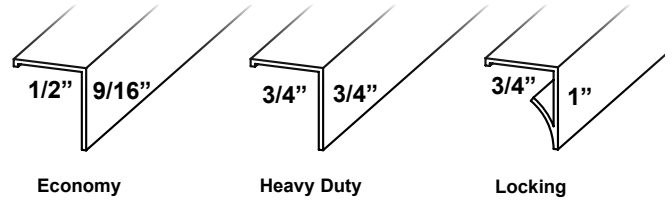

Stock	Description
Economy — .048 Wall Thickness	
I45330-15.00	Backskin Retainer - 1/2" x 9/16" x 15" - 300 pcs
I45330-15.50	Backskin Retainer - 1/2" x 9/16" x 15 1/2" - 300 pcs
I45330-16.00	Backskin Retainer - 1/2" x 9/16" x 16" - 300 pcs
I45330-17.00	Backskin Retainer - 1/2" x 9/16" x 17" - 300 pcs
I45330-17.25	Backskin Retainer - 1/2" x 9/16" x 17 1/4" - 300 pcs
I45330-18.00	Backskin Retainer - 1/2" x 9/16" x 18" - 300 pcs
I45330-18.25	Backskin Retainer - 1/2" x 9/16" x 18 1/4" - 300 pcs
I45330-18.50	Backskin Retainer - 1/2" x 9/16" x 18 1/2" - 300 pcs
I45330-19.00	Backskin Retainer - 1/2" x 9/16" x 19" - 300 pcs
I45330-20.00	Backskin Retainer - 1/2" x 9/16" x 20" - 300 pcs
I45330-20.25	Backskin Retainer - 1/2" x 9/16" x 20 1/4" - 300 pcs
I45330-20.31	Backskin Retainer - 1/2" x 9/16" x 20 5/16" - 300 pcs
I45330-21.00	Backskin Retainer - 1/2" x 9/16" x 21" - 300 pcs
I45330-21.63	Backskin Retainer - 1/2" x 9/16" x 21 5/8" - 300 pcs
I45330-22.00	Backskin Retainer - 1/2" x 9/16" x 22" - 300 pcs
I45330-23.00	Backskin Retainer - 1/2" x 9/16" x 23" - 300 pcs
I45330-23.25	Backskin Retainer - 1/2" x 9/16" x 23 1/4" - 300 pcs
I45330-23.31	Backskin Retainer - 1/2" x 9/16" x 23 5/16" - 300 pcs
I45330-24.00	Backskin Retainer - 1/2" x 9/16" x 24" - 300 pcs
Heavy Duty — .050 Wall Thickness	
I45310-15.50	Backskin Retainer - 3/4" x 3/4" x 15 1/2" - 300 pcs
I45310-17.25	Backskin Retainer - 3/4" x 3/4" x 17 1/4" - 300 pcs
I45310-17.50	Backskin Retainer - 3/4" x 3/4" x 17 1/2" - 300 pcs
I45310-18.50	Backskin Retainer - 3/4" x 3/4" x 18 1/2" - 300 pcs
I45310-20.25	Backskin Retainer - 3/4" x 3/4" x 20 1/4" - 300 pcs
I45310-20.31	Backskin Retainer - 3/4" x 3/4" x 20 5/16" - 300 pcs
I45310-20.50	Backskin Retainer - 3/4" x 3/4" x 20 1/2" - 300 pcs
I45310-21.00	Backskin Retainer - 3/4" x 3/4" x 21" - 300 pcs
I45310-23.25	Backskin Retainer - 3/4" x 3/4" x 23 1/4" - 300 pcs
I45310-23.31	Backskin Retainer - 3/4" x 3/4" x 23 5/16" - 300 pcs
I45310-23.50	Backskin Retainer - 3/4" x 3/4" x 23 1/2" - 300 pcs
I45310-24.00	Backskin Retainer - 3/4" x 3/4" x 24" - 300 pcs
Locking — .050 Wall Thickness	
I45316-17.50	Backskin Retainer - 3/4" x 1" x 17 1/2" - 300 pcs
I45316-20.50	Backskin Retainer - 3/4" x 1" x 20 1/2" - 300 pcs
I45316-21.00	Backskin Retainer - 3/4" x 1" x 21" - 300 pcs
I45316-23.50	Backskin Retainer - 3/4" x 1" x 23 1/2" - 300 pcs
I45316-24.00	Backskin Retainer - 3/4" x 1" x 24" - 300 pcs

Plastic Backskin

- Sold by lineal foot / rolls

Stock	Description
I45290	23 13/16" x 250' 20 gauge White Plastic Backskin
I45270	20 13/16" x 250' 20 gauge White Plastic Backskin

Vinyl Garage Door Threshold

- Black thermoplastic vinyl
- Blocks and repels - wind driven rain, snow, dirt, sand and leaves
- Saves money by reducing energy loss year round
- Keeps out rodents, snakes and small pests
- Comes pre-packaged with special threshold adhesive and instructions
- Installs quickly and easily in just minutes
- Used in combination with our astragal or weatherseal retainer rail and vinyl bottom weatherseal, provides a near perfect seal
- Will ship via UPS
- Installs in temperature ranging from 40° to 90° F
- Adhesive comes with every 10' of threshold

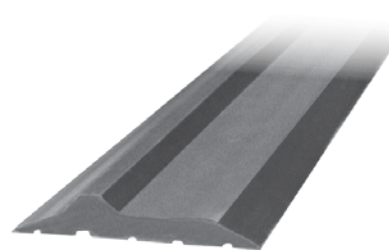

Stock	Description
I40359	8' Standard Duty Vinyl Garage Door Threshold with 1 Tube of Adhesive
I40360	10' Standard Duty Vinyl Garage Door Threshold with 1 Tube of Adhesive
I40361	16' Standard Duty Vinyl Garage Door Threshold with 2 Tubes of Adhesive
I40362	18' Standard Duty Vinyl Garage Door Threshold with 2 Tubes of Adhesive
I40363	20' Standard Duty Vinyl Garage Door Threshold with 2 Tubes of Adhesive
I40368	50' Standard Duty Bulk Vinyl Garage Door Threshold with 5 Tubes of Adhesive
I40369	100' Standard Duty Bulk Vinyl Garage Door Threshold with 10 Tubes of Adhesive
I40376	10.3 oz. Vinyl Adhesive
I40379	8' Heavy Duty Vinyl Garage Door Threshold with 1 Tube of Adhesive
I40380	10' Heavy Duty Vinyl Garage Door Threshold with 1 Tube of Adhesive
I40381	16' Heavy Duty Vinyl Garage Door Threshold with 2 Tubes of Adhesive
I40382	18' Heavy Duty Vinyl Garage Door Threshold with 2 Tubes of Adhesive
I40383	20' Heavy Duty Vinyl Garage Door Threshold with 2 Tubes of Adhesive
I40388	50' Heavy Duty Bulk Vinyl Garage Door Threshold with 5 Tubes of Adhesive
I40389	100' Bulk Heavy Duty Vinyl Garage Door Threshold with 10 Tubes of Adhesive

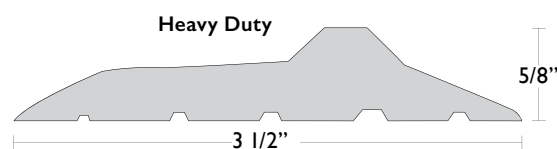
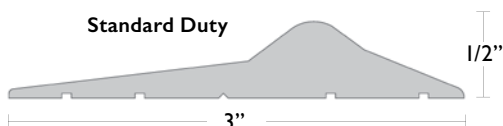

Aluminum Garage Door Threshold

- Heavy-Duty Aluminum threshold is suitable for commercial installations
- Blocks and repels - wind driven rain, snow, dirt, sand and leaves
- Saves money by reducing energy loss year round
- Keeps out rodents, snakes and small pests
- Installs quickly and easily in just minutes
- We recommend 1/4" x 2" concrete drive anchor and construction adhesive
- Used in combination with our astragal or weatherseal retainer rail and vinyl inserts, provides a near perfect seal
- Load tested at 7,000 pounds

Stock	Description
I40390	8' 2" Aluminum Garage Door Threshold - 2 pcs
I40391	9' 2" Aluminum Garage Door Threshold - 2 pcs
I40392	10' 2" Aluminum Garage Door Threshold - 2 pcs
I40393	12' 2" Aluminum Garage Door Threshold - 2 pcs
I40394	14' 2" Aluminum Garage Door Threshold - 2 pcs
I40395	16' 2" Aluminum Garage Door Threshold - 2 pcs
I40396	18' 2" Aluminum Garage Door Threshold - 2 pcs

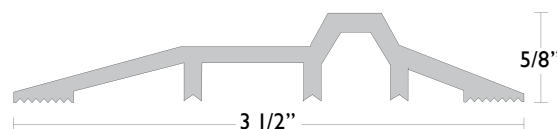

Sectional Top Seal - Single Contact

Single Contact Top Seal

- Co-extruded rigid and flexible PVC top seal
- Convenient packaging in two 100' rolls per carton
- Easily applied with TEK screws or rivets
- Standard color is black
- Installs onto tongue and groove or ship lap sections

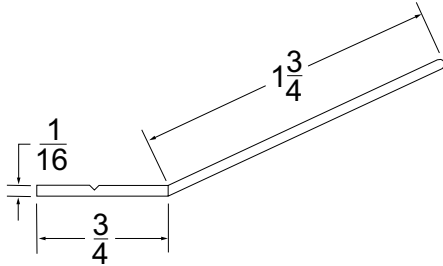

Stock	Description
I45400	Top Seal - Single Contact - Black - 2 100' Roll

Uni-Size Bottom Seal

- Fits 3/4" to 2" thick doors
- Available in multiple lengths ranging from 8' 2" and 18' 2"
- Available in black only
- 15 pieces per carton

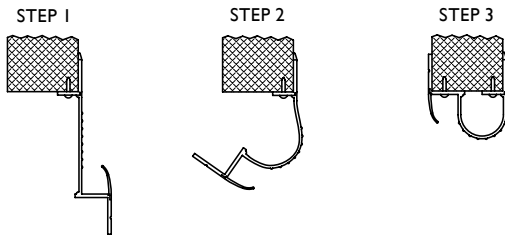
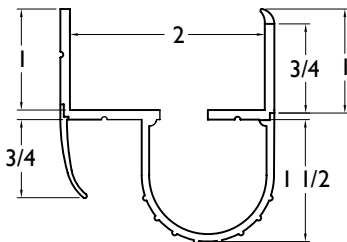

Stock	Description
I45700-0802	8' 2" - Uni-Size Bottom Seal 8 foot 2 inch - 15pcs
I45700-0902	9' 2" - Uni-Size Bottom Seal 8 foot 2 inch - 15pcs
I45700-1002	10' 2" - Uni-Size Bottom Seal 8 foot 2 inch - 15pcs
I45700-1202	12' 2" - Uni-Size Bottom Seal 8 foot 2 inch - 15pcs
I45700-1402	14' 2" - Uni-Size Bottom Seal 8 foot 2 inch - 15pcs
I45700-1602	16' 2" - Uni-Size Bottom Seal 8 foot 2 inch - 15pcs
I45700-1802	18' 2" - Uni-Size Bottom Seal 8 foot 2 inch - 15pcs

Sectional Top Seal - Double Contact

Dual Contact Top Seal

- Co-extruded rigid and flexible PVC top seal
- Easily applied with TEK screws or rivets
- Standard color is black
- Specifically for tongue and groove section

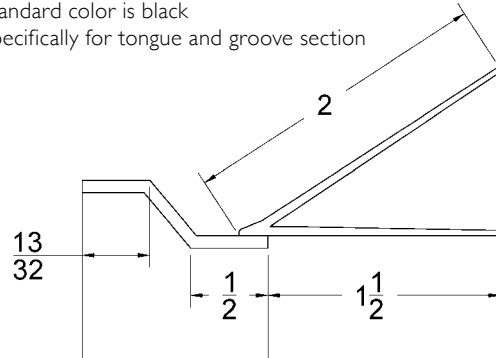

Stock	Description
I45410	Top Seal - Double Contact - 300' Roll
I45424	8' 2" Top Seal - Double Contact - 15 pcs
I45425	9' 2" Top Seal - Double Contact - 15 pcs
I45428	10' 2" Top Seal - Double Contact - 15 pcs
I45430	12' 2" Top Seal - Double Contact - 15 pcs
I45432	14' 2" Top Seal - Double Contact - 15 pcs
I45434	16' 2" Top Seal - Double Contact - 15 pcs
I45436	18' 2" Top Seal - Double Contact - 15 pcs

Superboard Insulation

Superboard

- National Door's Superboard is an EPS foam sheet with a bonded plastic film applied to one side
- Available in 20 1/2" and 23 1/2" widths
- Residential & Commercial kits include the EPS board and locking retainers

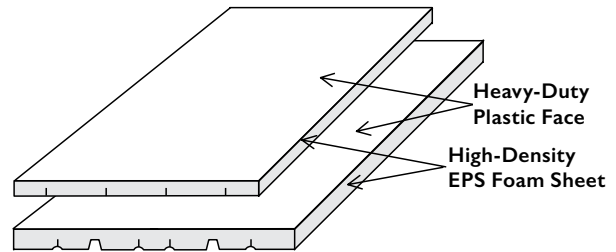

Stock	Description
I45020	Residential Kit - 8' Door - 1 3/8" x 20 1/2" x 48" - 8 pieces
I45025	Residential Kit - 9' Door - 1 3/8" x 20 1/2" x 54" - 8 pieces
I45030	Commercial Kit - 1 3/8" x 23 1/2" x 48" - 8 pieces
I45035	Commercial Kit - 1 3/4" x 23 1/2" x 48" - 6 pieces

Direct Dial: (817) 834-7300

Sectional Bottom Seal - Double Contact

Stock	Description
I45504	8' 2" - 1 3/8" Bottom Seal - 12 pcs
I45508	10' 2" - 1 3/8" Bottom Seal - 12 pcs
I45510	12' 2" - 1 3/8" Bottom Seal - 12 pcs
I45512	14' 2" - 1 3/8" Bottom Seal - 12 pcs
I45514	16' 2" - 1 3/8" Bottom Seal - 12 pcs
I45516	18' 2" - 1 3/8" Bottom Seal - 12 pcs
I45524	8' 2" - 1 3/4" Bottom Seal - 12 pcs
I45526	9' 2" - 1 3/4" Bottom Seal - 12 pcs
I45528	10' 2" - 1 3/4" Bottom Seal - 12 pcs
I45530	12' 2" - 1 3/4" Bottom Seal - 12 pcs
I45532	14' 2" - 1 3/4" Bottom Seal - 12 pcs
I45534	16' 2" - 1 3/4" Bottom Seal - 12 pcs
I45536	18' 2" - 1 3/4" Bottom Seal - 12 pcs
I45544	8' 2" - 2" Bottom Seal - 6 pcs
I45546	9' 2" - 2" Bottom Seal - 6 pcs
I45548	10' 2" - 2" Bottom Seal - 6 pcs
I45550	12' 2" - 2" Bottom Seal - 6 pcs
I45552	14' 2" - 2" Bottom Seal - 6 pcs
I45554	16' 2" - 2" Bottom Seal - 6 pcs
I45556	18' 2" - 2" Bottom Seal - 6 pcs

- Co-extruded rigid and flexible PVC bottom seal
- 2 points of contact
- Available for 1 3/8", 1 3/4" and 2" section thicknesses
- Convenient packaging, 6 pieces per carton or 12 pieces
- Ideal for field replacement
- Easy one step installation
- Can be applied with TEK screws or rivets
- Standard color is black

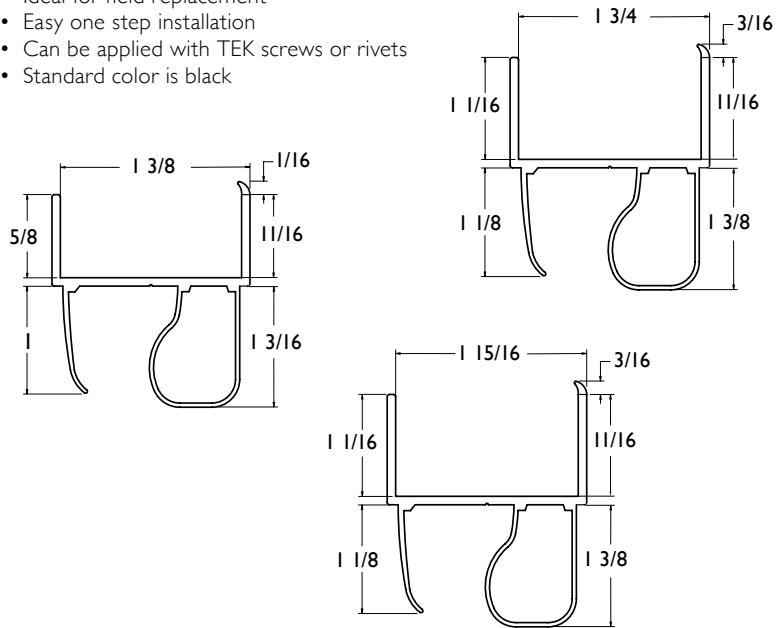

Ship Lap Bottom Seal

Ship Lap Sectional Bottom Seal

- Co-extruded rigid and flexible PVC bottom seal
- 2 points of contact
- Easily applied with TEK screws or rivets
- Standard color is black
- 2" thick doors

Stock	Description
I45564	8' 2" - 2" Bottom Seal - Dual Shiplap - 6 pcs
I45568	10' 2" - 2" Bottom Seal - Dual Shiplap - 6 pcs
I45570	12' 2" - 2" Bottom Seal - Dual Shiplap - 6 pcs
I45572	14' 2" - 2" Bottom Seal - Dual Shiplap - 6 pcs
I45574	16' 2" - 2" Bottom Seal - Dual Shiplap - 6 pcs
I45576	18' 2" - 2" Bottom Seal - Dual Shiplap - 6 pcs

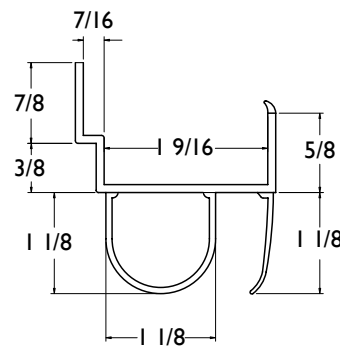

Tongue and Groove Bottom Seal

Tongue and Groove Bottom Seal

- Co-extruded rigid and flexible PVC bottom seal
- 2 points of contact
- Easily applied with TEK screws or rivets
- Standard color is black
- Other lengths available by special order

Stock	Description
I42408-160	16' Tongue and Groove Bottom Seal - 20 pcs
I42408-180	18' Tongue and Groove Bottom Seal - 20 pcs

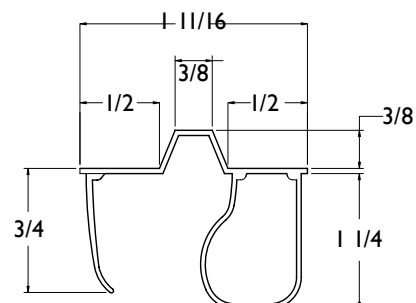

Rolling Steel Bottom Seal

- Co-extruded rigid and flexible PVC bottom seal
- Easily applied between the dual angles
- Packed two 75' rolls
- Available in black

Stock	Description
145620	Rolling Steel Bottom Seal - 150'

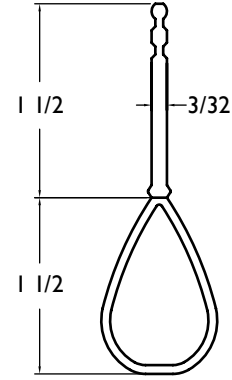

Rolling Steel Header Seal

Rolling Steel Header Seal

- Co-extruded rigid and flexible PVC header seal
- Makes quick work of sealing the header of a rolling steel door
- Three convenient lengths: 11, 13 and 15 feet
- Standard color is black

Stock	Description
145609	11' Rolling Steel Top Seal - 6 pcs
145611	13' Rolling Steel Top Seal - 6 pcs
145613	15' Rolling Steel Top Seal - 6 pcs

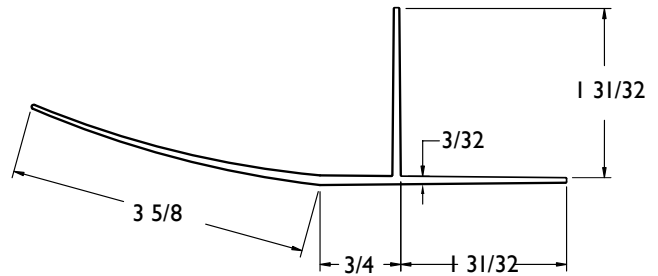

Rolling Steel Guide Seal

- Co-extruded rigid and flexible PVC header seal
- Makes quick work of sealing the header of a rolling steel door
- Standard color is grey

Stock	Description
145648	10' 6" Rolling Steel Guide Seal - 12pcs
145650	12' 6" Rolling Steel Guide Seal - 12pcs
145652	14' 6" Rolling Steel Guide Seal - 12pcs
145654	16' 6" Rolling Steel Guide Seal - 12pcs

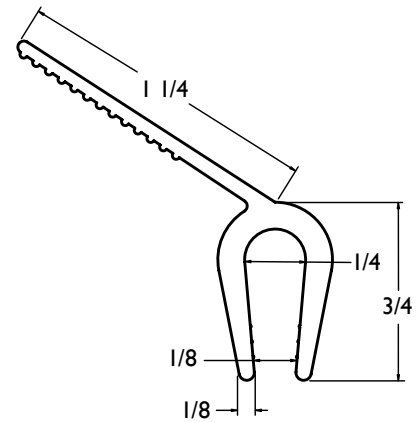

CARRIAGE HARDWARE



CARRIAGE HARDWARE

POLYMER DOOR HARDWARE • STAMPED STEEL DOOR HARDWARE • MAGNETIC POLYMER DOOR HARDWARE • HINGES • STAMPED STEEL DOOR KNOCKER • STAMPED STEEL LIFT/PULL HANDLES • 120° CORNER BRACKETS • 90° CORNER BRACKETS • HAMMERED IRON HINGES • HAMMERED IRON LIFT/PULL HANDLES • HAMMERED IRON DOOR KNOCKERS

Magnetic High Performance Polymer Carriage Door Hardware

- Strong rare earth magnets
- Vinyl magnet cover
- No holes required in door surface
- Quick and accurate installation without tools or drilling
- Will not void the manufacture's warranty
- Injection molded
- Temperature stable to 195° F
- Does not fade
- Paintable
- Made in the U.S.A.

Stock	Description
2CM500B-16	16" Spear with Square Clavos
2CM500B-18	18" Spear with Square Clavos
2CM500B-24	24" Spear with Square Clavos
2CM510B-16	16" Spear with Round Clavos
2CM510B-18	18" Spear with Round Clavos
2CM510B-24	24" Spear with Round Clavos
2CM600B-16	16" Spear with Hinge Square Clavos
2CM600B-18	18" Spear with Hinge Square Clavos
2CM610B-16	16" Spear with Hinge Round Clavos
2CM610B-18	18" Spear with Hinge Round Clavos
2CM700B-8	8" Handle with Square Clavos
2CM700B-10	11" Handle with Square Clavos
2CM710B-8	8" Handle with Round Clavos
2CM710B-11	11" Handle with Round Clavos



Available with a square or round style clavos



Surface finishes on all carriage door hardware are subject to change

Direct Dial: (817) 834-7300

High Performance Polymer Carriage Door Hardware

- Built with a true hammered iron look
- Made from the finest black resins
- Temperature stable to 195° F
- Does not fade, paintable, UV stable
- Installed using screws (sold separately)
- Round or square clavos available
- Made in the U.S.A.

Stock	Description
2CM110B-16	16" Spear with Faux Hinge
2CM110B-18	18" Spear with Faux Hinge
2CM100B-24	24" Spear Hinge Only
2CM100B-18	18" Spear Hinge Only
2CM100B-16	16" Spear Hinge Only
2CM200B-8	8" Hammered Lift Handle
2CM200B-11	11" Hammered Lift Handle
2CM900B-TRH	Round Clavos with Hole
2CM900B-TSH	Diamond Clavos with Hole
2CM95ZB	Flat Head Screw #8 x 3/4 -25 pcs

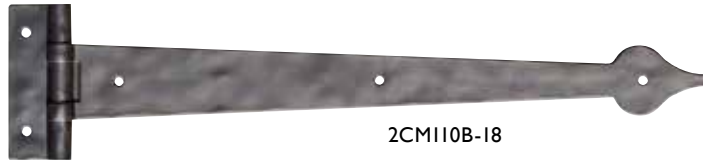
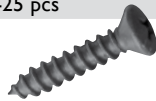

Surface finishes on all carriage door hardware are subject to change

Email: sales@natdoor.com



Stamped Steel Strap Hinge

- Powder coated for quality and durability
- Available in 16", 18", 24" and 30"
- Flat matte finish

Stock	Description
2CD616	Stamped Steel Strap Hinge - 16"
2CD618	Stamped Steel Strap Hinge - 18"
2CD624	Stamped Steel Strap Hinge - 24"
2CD630	Stamped Steel Strap Hinge - 30"

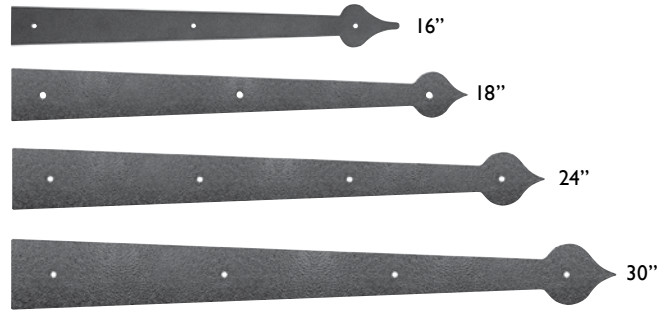

Stamped Steel Heritage Hinge

- Powder coated for quality and durability
- Available in 18", 24" and 30"
- Flat matte finish

Stock	Description
2CD518	Stamped Steel Heritage Hinge - 18"
2CD524	Stamped Steel Heritage Hinge - 24"
2CD530	Stamped Steel Heritage Hinge - 30"

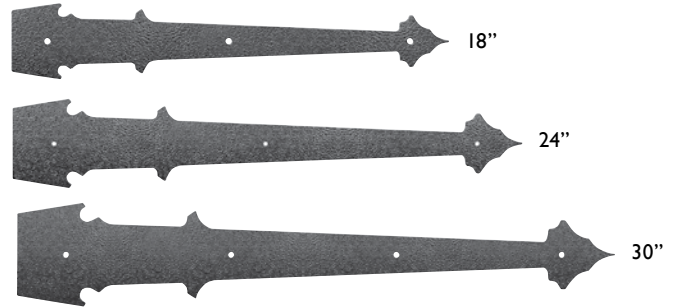

Stamped Steel Fleur-de-lis Hinge

- Powder coated for quality and durability
- Flat matte finish

Stock	Description
2CD416	Stamped Steel Fleur-de-lis Hinge - 16"



Stamped Steel Bean Head Hinge

- Powder coated for quality and durability
- Flat matte finish

Stock	Description
2CD316	Stamped Steel Bean Head Hinge - 16"



Stamped Steel Door Knocker

- Powder coated for quality and durability
- Flat matte finish

Stock	Description
2CD151	Stamped Steel Bean Head Door Knocker



Stamped Steel Lift/Pull Handles

- Powder coated for quality and durability
- Flat matte finish

Stock	Description
2CD184	Stamped Steel Spear Lift Handle - 10-1/2"
2CD185	Stamped Steel Narrow Spear Lift Handle - 9-7/8"
2CD164	Stamped Steel Spear Lift Handle - 8"
2CD161	Stamped Steel Bean Lift Handle - 7"
2CD162	Stamped Steel Fleur-de-lis Lift Handle - 8"

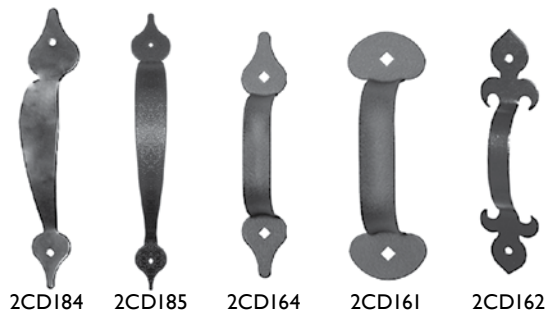

Surface finishes on all carriage door hardware are subject to change

Direct Dial: (817) 834-7300

120° Corner Brackets

- Powder coated for quality and durability
- Looks great an any structure
- Inexpensive way to spruce up existing doors
- 10" height and width
- Stamped Steel

Stock	Description
2CDI11	120° Angle Bracket - Bean Head
2CDI12	120° Angle Bracket - Fleur-de-lis
2CDI13	120° Angle Bracket - Heritage
2CDI14	120° Angle Bracket - Spear

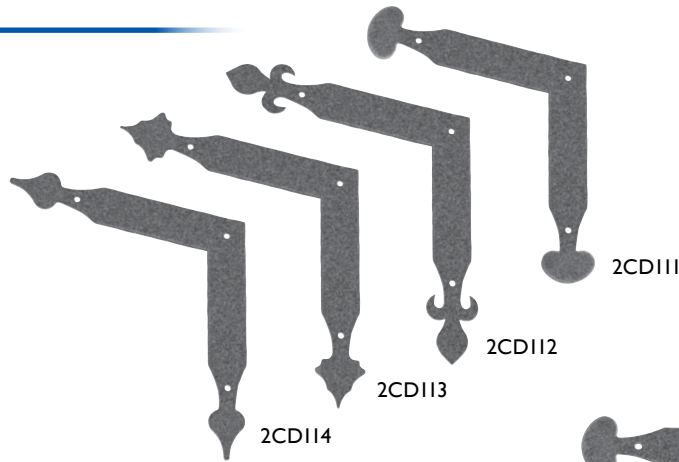

90° Corner Brackets

Stock	Description
2CDI01	90° Corner Bracket - Bean Head
2CDI02	90° Corner Bracket - Fleur-de-lis
2CDI03	90° Corner Bracket - Heritage
2CDI04	90° Corner Bracket - Spear

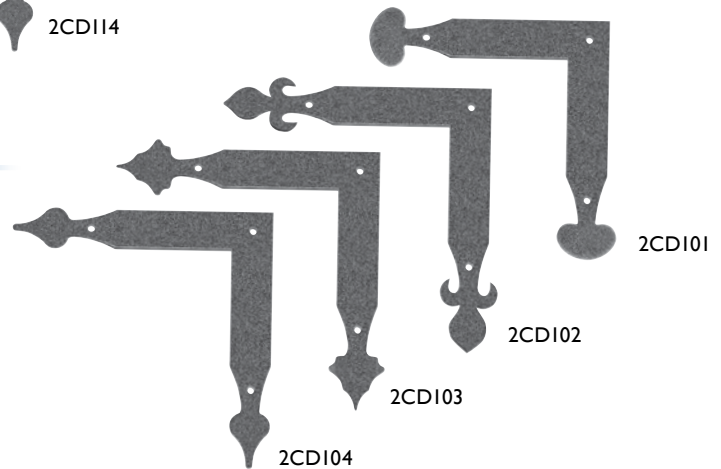

Hammered Iron Hinges

- Powder coated for quality and durability
- Flat matte finish

Stock	Description
2CD711	Hammered Iron Bean Head Hinge - 16"
2CD712	Hammered Iron Fleur-de-lis Hinge - 16"
2CD714	Hammer Iron Spear Hinge- 16"
2CD718	Hinged Hammered Iron Spear Hinge - 16"



Hammered Iron Lift/Pull Handles

- Powder coated for quality and durability
- Flat matte finish

Stock	Description
2CD231	Hammered Iron Bean Head Lift Handle - 7"
2CD232	Hammered Iron Fleur-de-lis Lift Handle - 7"
2CD234	Hammered Iron Spear Lift Handle - 7"
2CD241	Hammered Iron Bean Head Lift Handle - 9"



Surface finishes on all carriage door hardware are subject to change

Email: sales@natdoor.com



Hammered Iron Lift Handle Sets

- Powder coated for quality and durability
- Flat matte finish

Stock	Description
2CD200	Hammered Iron Fleur-de-lis Lift Handle Set
2CD201	Hammered Iron Lift Handle with Escutcheon
2CD202	Hammered Iron Lift Handle with Escutcheon with Key Hole

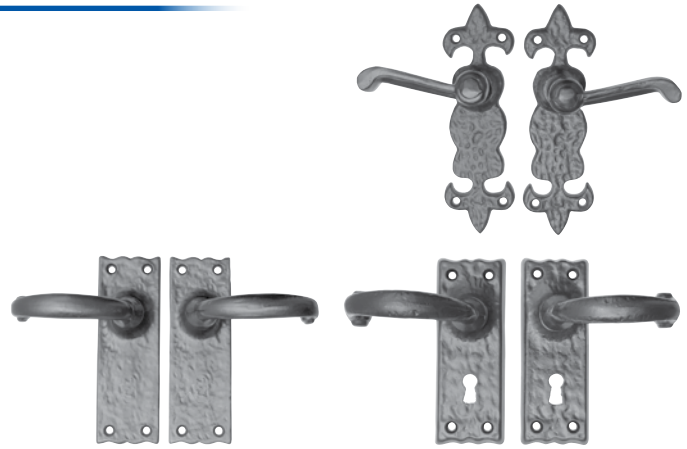

Hammered Iron Door Knockers

- Hammered iron look
- Installed from interior

Stock	Description
2CD080	Hammered Iron Door Knocker
2CD090	Hammered Iron Lion Head Door Knocker



Door Screws and Studs

- Iron stud with separate screw for faster installs
- Powder coated studs to match handle and hinges
- Black painted screws for installing all Carriage Door Hardware

Stock	Description
2CD021	Iron Door Studs - Black with Screws - 10 pcs
2CD040	National #10 x 1" Black Screws - 25 pcs
2CD041	National #10 x 3/4" Black Screws - 2000 pcs



Pyramid Clavos

- With screw back
- Powder coated for quality and durability

Stock	Description
2CD001	3/4" Die Cast Pyramid Clavos with Screw
2CD002	1-1/2" Die Cast Pyramid Clavos with Screw
2CD003	1-3/4" Die Cast Pyramid Clavos with Screw
2CD004	2" Die Cast Pyramid Clavos with Screw

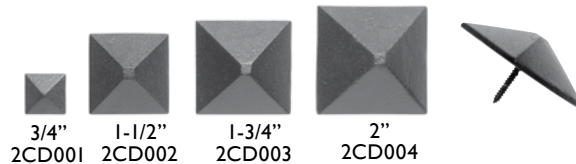

Round Clavos

- With nail back
- Hammered iron look

Stock	Description
2CD011	7/8" Die Cast Round Clavos with Nail
2CD012	1" Die Cast Round Clavos with Nail
2CD013	1-7/8" Die Cast Round Clavos with Nail

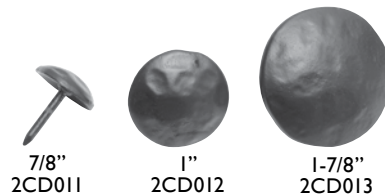

Surface finishes on all carriage door hardware are subject to change

WINDOW FRAMES

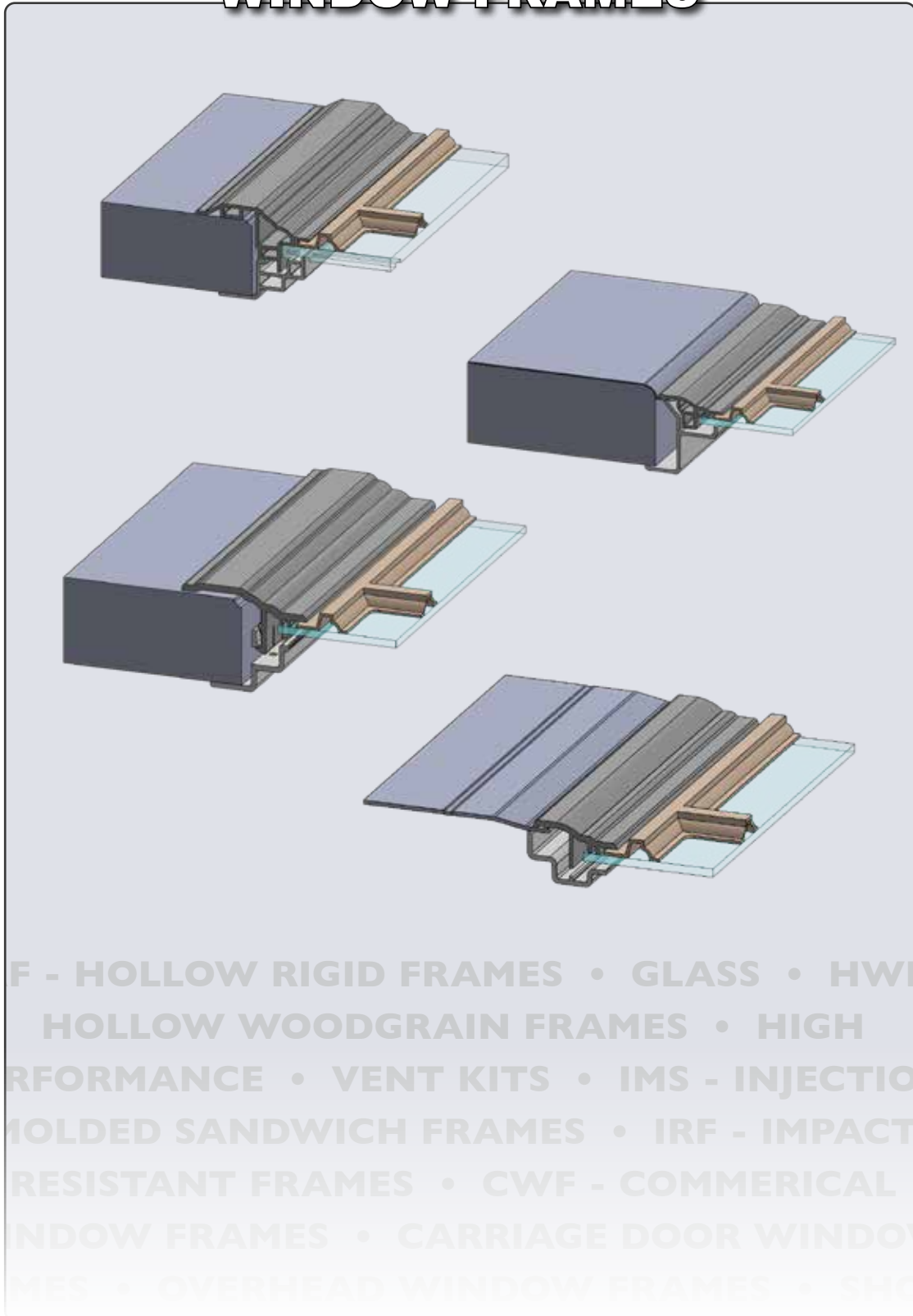

WINDOW FRAMES

F - HOLLOW RIGID FRAMES • GLASS • HWI
 HOLLOW WOODGRAIN FRAMES • HIGH
 PERFORMANCE • VENT KITS • IMS - INJECTION
 MOLDED SANDWICH FRAMES • IRF - IMPACT
 RESISTANT FRAMES • CWF - COMMERCIAL
 WINDOW FRAMES • CARRIAGE DOOR WINDOW
 FRAMES • OVERHEAD WINDOW FRAMES • SHC

HRF Window Frame Information Sheet

Frame Type: Hollow Rigid Frame

Features:

- Made from high performance ASA material
- Heavy duty, high performance screw together frame
- Direct replacement / retrofit for the SRF window frame
- Accommodates the Stylecraft™ or Styleline™ Design Trim
- Exterior frame can be color matched to OEM section colors
- Compatible with 1/8" or 1/2" insulated glass
- Includes caulking material applied to the glazing area and section interface locations
- Welded frame assembly

Key to a clean installation is the proper location of the section cut out. We recommend the use of a cut out template for consistency. We also recommend locator holes be drilled within the layout area when using a Shear, Nibbler or Router.

Recommended Installation Tools:

- Solid Work Table
- Back Up Support Frame to keep frame snug against the section during installation
- Torque Limited Screw Gun

Additional Features:

Colors are available in collaboration with the door manufacturer to blend the frame with the door and the custom painted Design Trim.

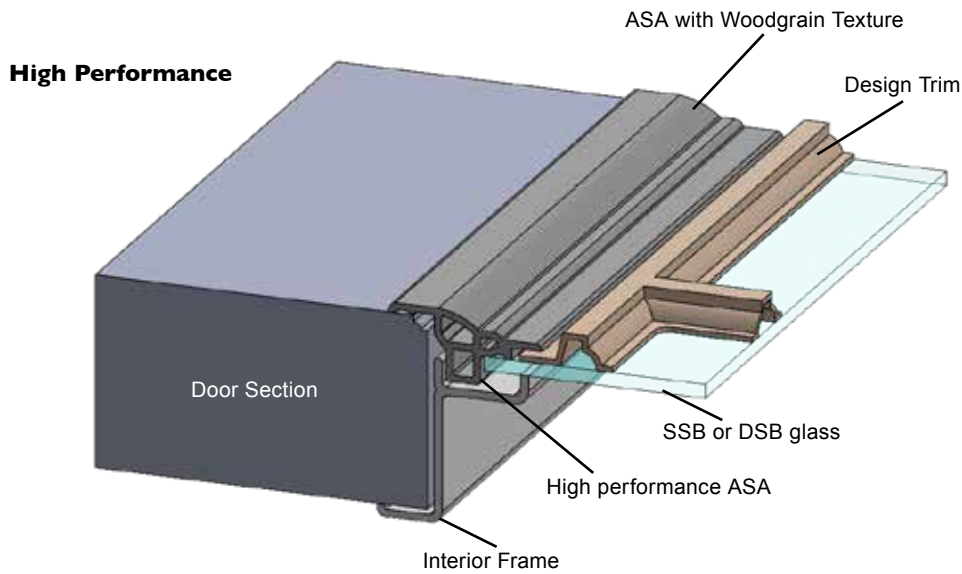

HRF- P Style Window Frame

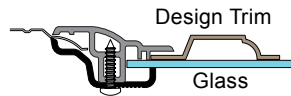

HRF- IP Style Window Frame

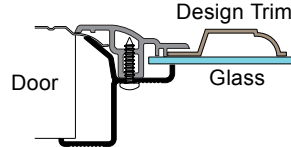

HRF- SG Style Window Frame

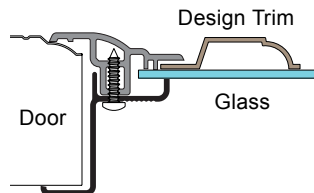

HRF- IG Style Window Frame

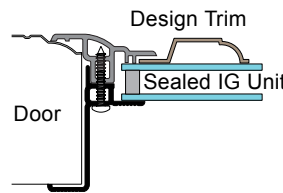

Above illustrations are only representative of actual designs. Actual designs may vary between sizes and manufacturers. The above designs are covered by one or more U.S. Patents. Other U.S. patent applications are pending.

HWF Window Frame Information Sheet

Frame Type: Hollow Woodgrain Frame

Features:

- Made from high performance ASA material
- Heavy duty, high performance screw together frame
- Woodgrain textured exterior
- Direct replacement / retrofit for the SWF window frame
- Accommodates the Stylecraft™ or Styleline™ Design Trim
- Exterior frame can be color matched to OEM section colors
- Compatible with 1/8" or 1/2" insulated glass
- Includes caulking material applied to the glazing area and section interface locations
- Welded frame assembly

Key to a clean installation is the proper location of the section cut out. We recommend the use of a cut out template for consistency. We also recommend locator holes be drilled within the layout area when using a Shear, Nibbler or Router.

Recommended Installation Tools:

- Solid Work Table
- Back Up Support Frame to keep frame snug against the section during installation
- Torque Limited Screw Gun

Additional Features:

Colors are available in collaboration with the door manufacturer to blend the frame with the door and the custom painted Design Trim.

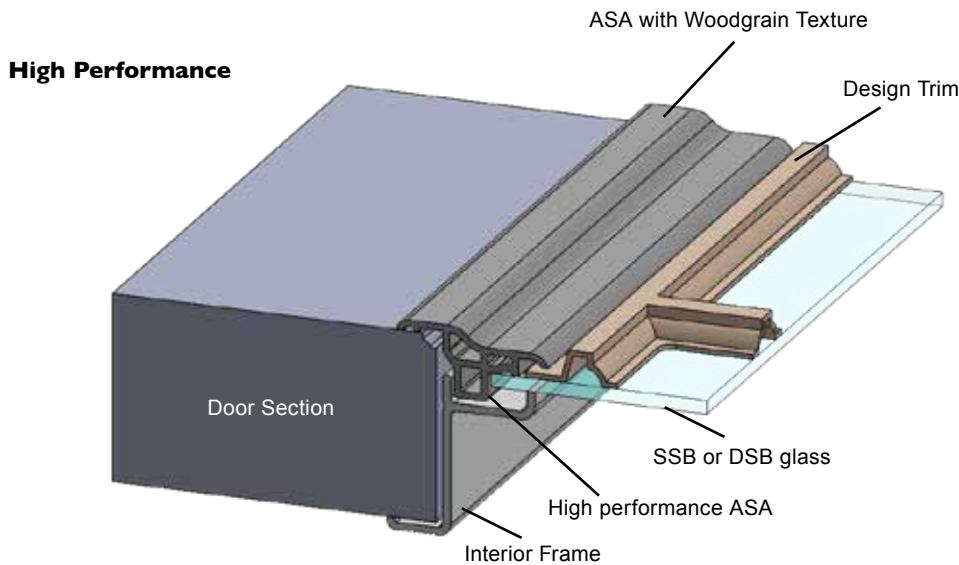

HWF- P Style Window Frame

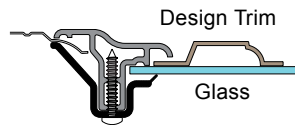

HWF- IP Style Window Frame

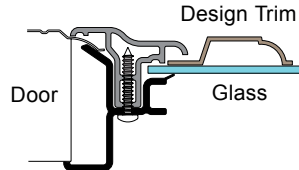

HWF- SG Style Window Frame

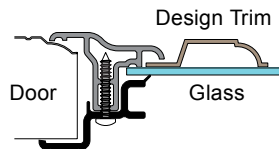

HWF- IG Style Window Frame

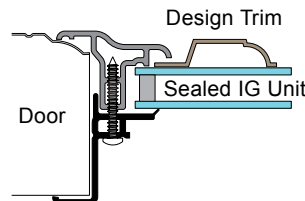

Above illustrations are only representative of actual designs. Actual designs may vary between sizes and manufacturers. The above designs are covered by one or more U.S. Patents. Other U.S. patent applications are pending

SWF Window Frame Information Sheet

Frame Type: Screw Together Window Frame

Features:

- Made from blown PVC material
- Woodgrain textured exterior
- Screw together frame
- Accommodates the Stylecraft™ or Styleline™ Design Trim
- Exterior frame can be color matched to OEM section colors
- Compatible with 1/8" or 1/2" insulated glass
- Welded frame assembly

Key to a clean installation is the proper location of the section cut out. We recommend the use of a cut out template for consistency. We also recommend locator holes be drilled within the layout area when using a Shear, Nibbler or Router.

Recommended Installation Tools:

- Solid Work Table
- Back Up Support Frame to keep frame snug against the section during installation
- Torque Limited Screw Gun

Additional Features:

Colors are available in collaboration with the door manufacturer to blend the frame with the door and the custom painted Design Trim.

Standard Duty Performance

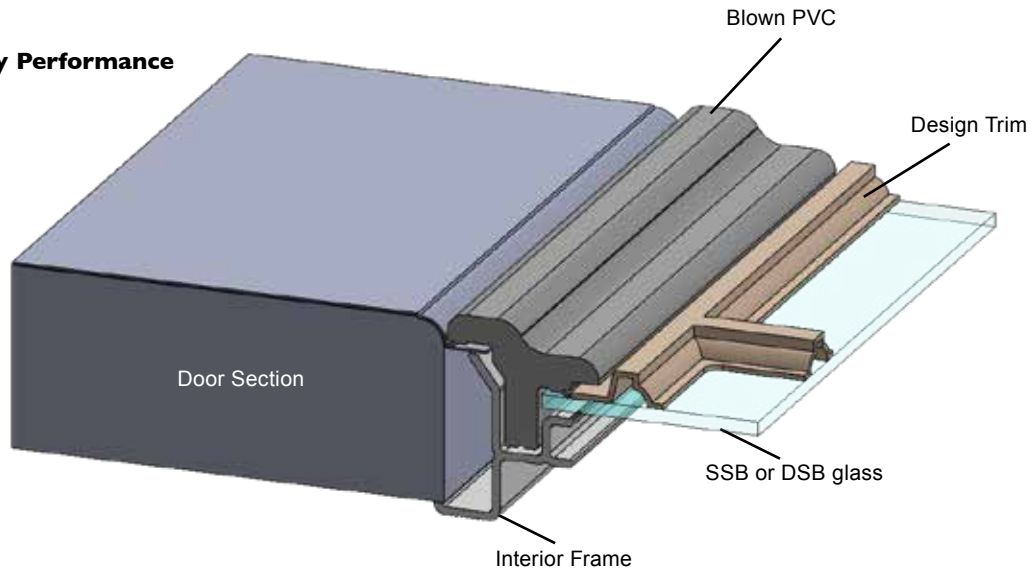

SWF-P Style Window Frame

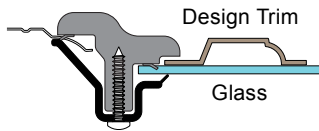

SWF-IP Style Window Frame

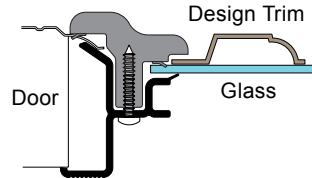

SWF- SG Style Window Frame

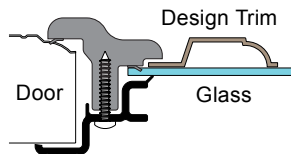

SWF- IG Style Window Frame

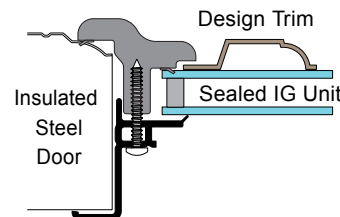

Above illustrations are only representative of actual designs. Actual designs may vary between sizes and manufacturers. The above designs are covered by one or more U.S. Patents. Other U.S. patent applications are pending.

IMS Window Frame Information Sheet

Frame Type: Injection Molded Sandwich Frame

Features:

- Patented snap together installation method; reduces installation time per frame by 60% vs. conventional screw together frames
- Available for multiple door thicknesses
- Accommodates Stylecraft™ or Styleline™ Design Trim
- Only available in high performance ASA materials
- Exterior frame can be color matched to OEM section colors
- Tested to withstand minimum of +/- 60 PSF windload
- Compatible with 1/8" or 1/2" insulated glass
- Includes caulking material applied to glazing area and section interface locations

Key to a clean installation is the proper location of the section cut out. We recommend the use of a cut out template for consistency. We also recommend locator holes be drilled within the layout area when using a Shear, Nibbler or Router.

Recommended Installation Tools:

- Solid Work Table
- Back Up Support Frame to keep frame snug against the section during installation
- Rubber Hammer

Additional Features:

Colors are available in collaboration with the door manufacturer to blend the frame with the door and the custom painted Design Trim.

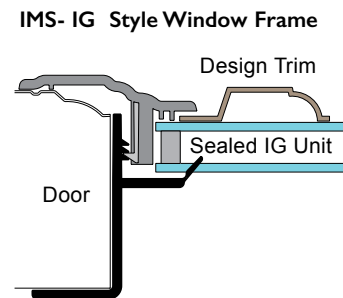
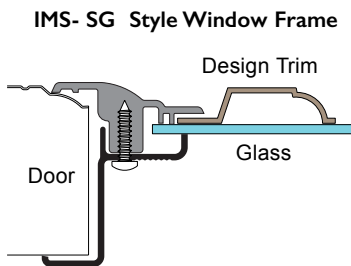
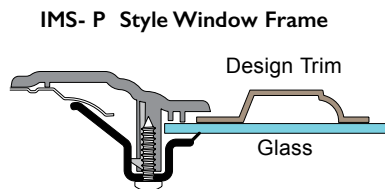
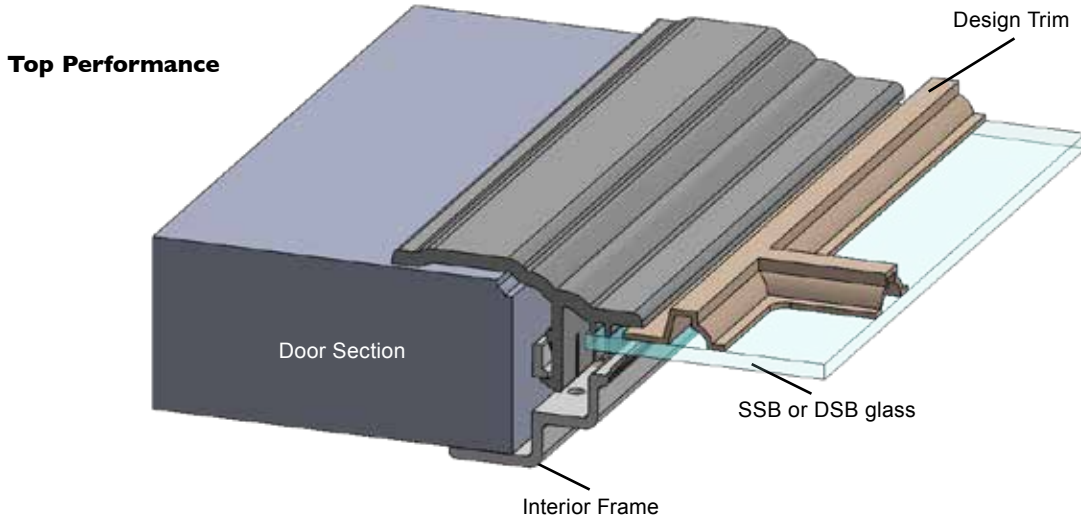

Above illustrations are only representative of actual designs. Actual designs may vary between sizes and manufacturers. The above designs are covered by one or more U.S. Patents. Other U.S. patent applications are pending.

IMF Window Frame Information Sheet

Frame Type: Injection Molded Frame

Features:

- Patented snap together installation method; reduces installation time per frame up to 60% versus conventional screw together frames
- Snap together feature available for pan doors only
- Accommodates Stylecraft™ or Styleline™ Design Trim
- Available in exterior grade PVC or high performance ASA materials
- Exterior frame can be color matched to OEM section colors
- Tested to withstand minimum of +/- 60 PSF windload
- Available in 1/8" or 1/2" glass
- Includes caulking material applied to glazing area and section interface locations
- Optional screw together interior available for other door thicknesses

Key to a clean installation is the proper location of the section cut out. We recommend the use of a cut out template for consistency. We also recommend locator holes be drilled within the layout area when using a Shear, Nibbler or Router.

Recommended Installation Tools:

- Solid Work Table
- Back Up Support Frame to keep frame snug against the section during installation
- Rubber Hammer

Additional Features:

Colors are available in collaboration with the door manufacturer to blend the frame with the door and the custom painted Design Trim.

Speed / High Performance

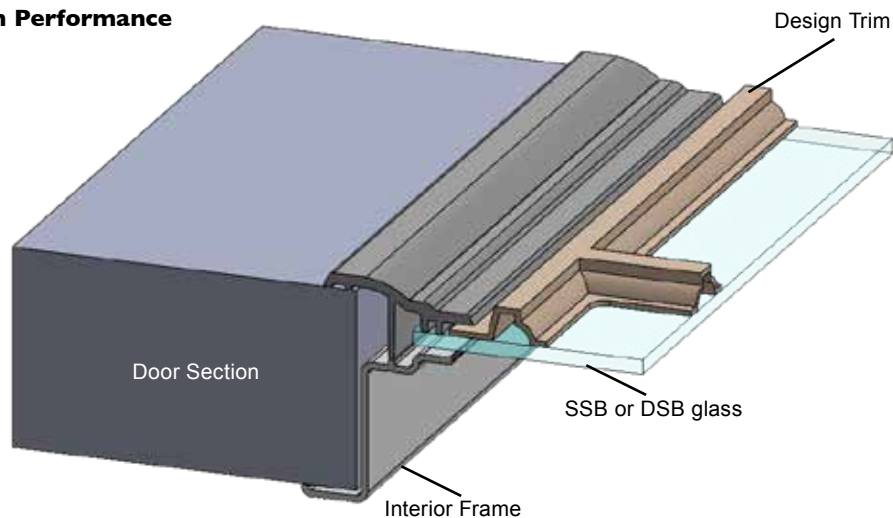

IMF- P Style Window Frame

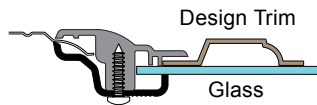

IMF- IP Style Window Frame

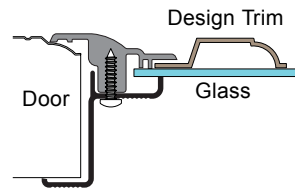

IMF- SG Style Window Frame

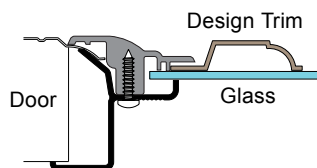

IMF- IG Style Window Frame

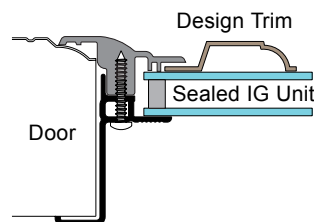

Above illustrations are only representative of actual designs. Actual designs may vary between sizes and manufacturers. The above designs are covered by one or more U.S. Patents. Other U.S. patent applications are pending.

IRF Window Frame Information Sheet

Frame Type: Impact Resistant Frame

Features:

- Successfully tested and passed large missile impact testing and cycling requirements as specified in DASTMA 115
- Accommodates Stylecraft™ or Styleline™ Design Trim
- Extreme performance aircraft quality aluminum extrusions
- Exterior frame can be color matched to OEM section colors
- Tested to withstand minimum of +/- 60 PSF windload
- Available with clear, frost, or dark impact resistant polycarbonate
- Includes caulking material applied to glazing area and section interface locations
- Other window profiles available
- Contact your OEM for information and availability

Key to a clean installation is the proper location of the section cut out. We recommend the use of a cut out template for consistency. We also recommend locator holes be drilled within the layout area when using a Shear, Nibbler or Router.

Recommended Installation Tools:

- Solid Work Table
- Back Up Support Frame to keep frame snug against the section during installation
- Torque Limited Screw Gun

Additional Features:

Colors are available in collaboration with the door manufacturer to blend the frame with the door and the custom painted Design Trim.

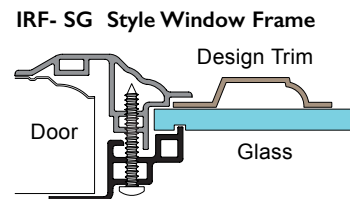
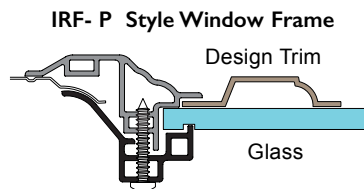
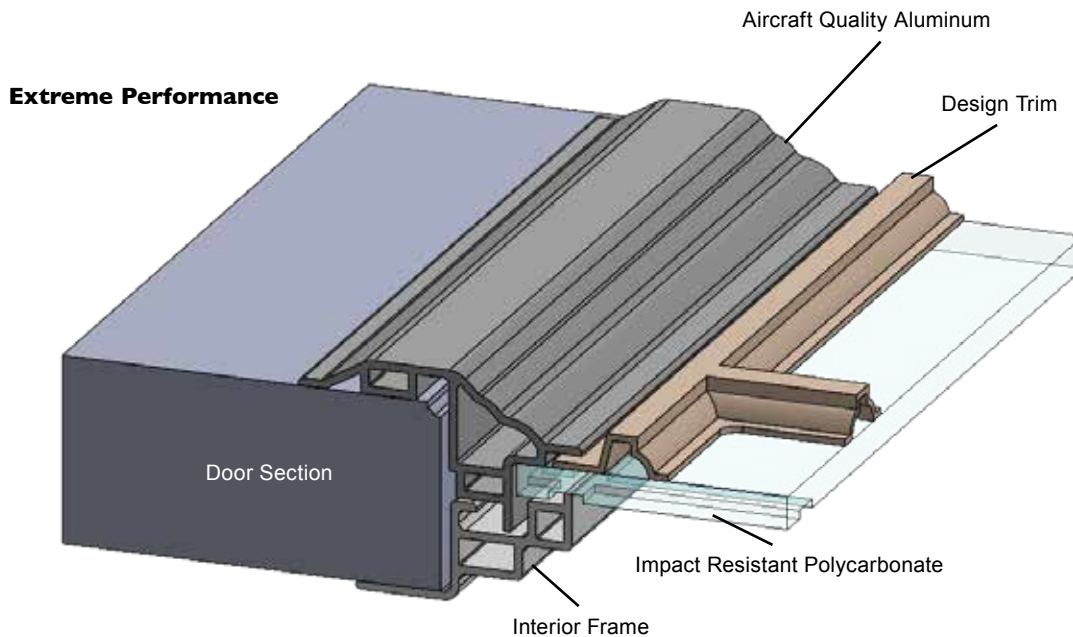

Above illustrations are only representative of actual designs. Actual designs may vary between sizes and manufacturers. The above designs are covered by one or more U.S. Patents. Other U.S. patent applications are pending.

CWF Window Frame Information Sheet

Frame Type: Commercial Window Frame

Features:

- Made from blown PVC material
- Woodgrain textured exterior
- Screw together frame
- Exterior frame available in white only
- Compatible with 1/8" or 1/2" insulated glass
- Welded frame assembly
- Includes two flexible vinyl seals on the exterior frame which eliminates the need for additional caulking

Key to a clean installation is the proper location of the section cut out. We recommend the use of a cut out template for consistency. We also recommend locator holes be drilled within the layout area when using a Shear, Nibbler or Router.

Recommended Installation Tools:

- Solid Work Table
- Back Up Support Frame to keep frame snug against the section during installation
- Torque Limited Screw Gun

Standard Performance

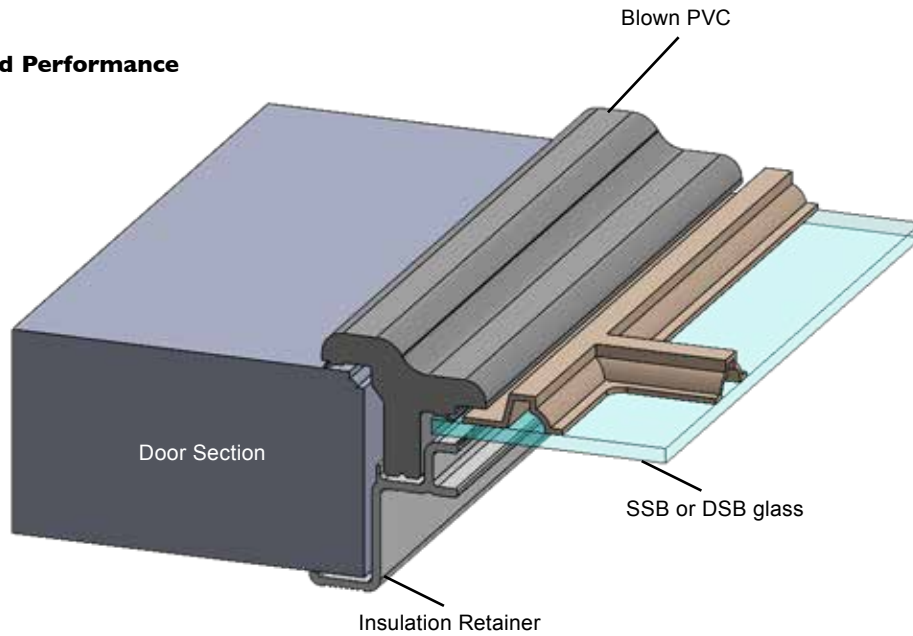

CWF- P Style Window Frame

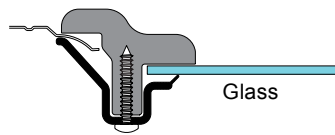

CWF- IP Style Window Frame

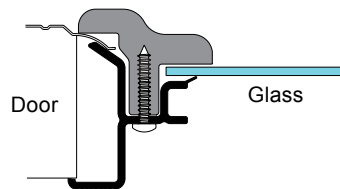

CWF- SG Style Window Frame

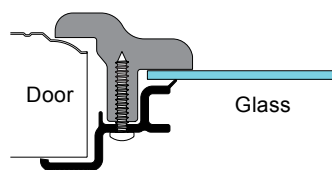

CWF- IG Style Window Frame

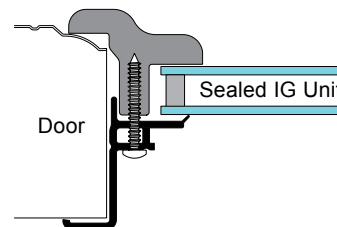

Above illustrations are only representative of actual designs. Actual designs may vary between sizes and manufacturers. The above designs are covered by one or more U.S. Patents. Other U.S. patent applications are pending.

CMF Window Frame Information Sheet

Frame Type: Commercial Molded Frame

Features:

- Made from glass reinforced polypropylene
- Pebble grain texture
- Screw together frame
- Available in black and white
- Compatible with pan doors and insulated doors up to 3" thick
- Direct replacement for competitor's commercial frames
- Includes caulking material applied to glazing area and section interface location
- Black Frames - Made from Polypropylene and are not paintable
- White Frames - Made from high heat ASA and are paintable

Key to a clean installation is the proper location of the section cut out. We recommend the use of a cut out template for consistency. We also recommend locator holes be drilled within the layout area when using a Shear, Nibbler or Router.

Recommended Installation Tools:

- Solid Work Table
- Back Up Support Frame to keep frame snug against the section during installation
- Torque Limited Screw Gun

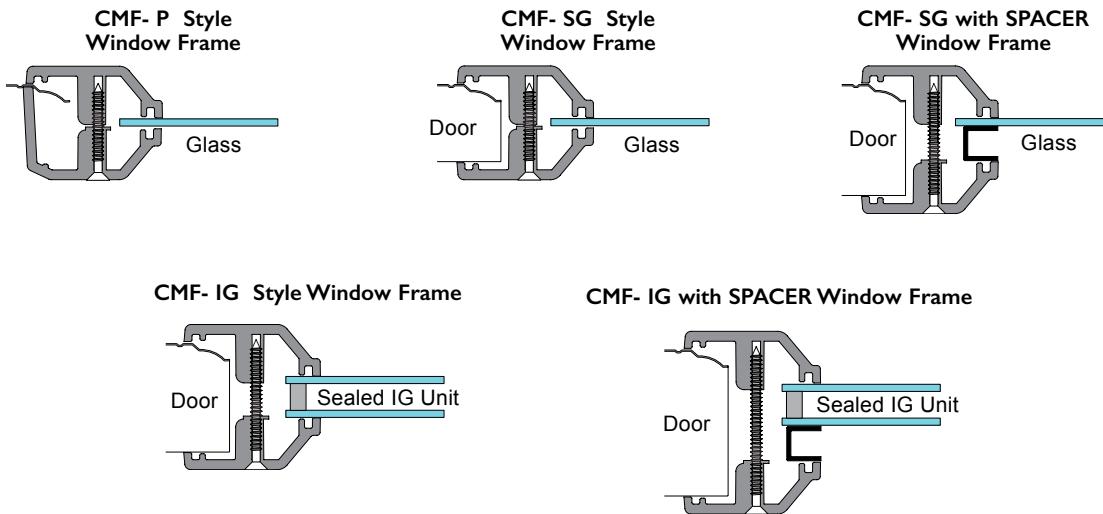
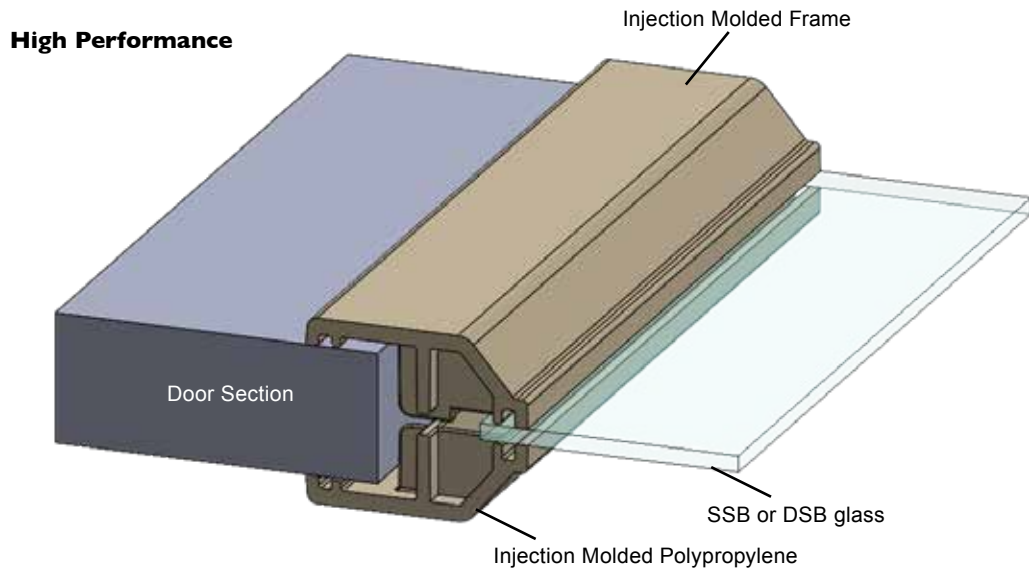

Above illustrations are only representative of actual designs. Actual designs may vary between sizes and manufacturers. The above designs are covered by one or more U.S. Patents. Other U.S. patent applications are pending

AWF Window Frame Information Sheet

Frame Type: Aluminum Window Frame

Features:

- Aluminum exterior
- PVC interior
- Two distinctive designs
- Custom Stylecraft™ and Styleline™ Design Trim available upon request
- Exterior frame can be color matched to OEM section colors
- Include caulking material applied to glazing area and section interface locations
- Used in High Heat Applications

Key to a clean installation is the proper location of the section cut out. We recommend the use of a cut out template for consistency. We also recommend locator holes be drilled within the layout area when using a Shear, Nibbler or Router.

Recommended Installation Tools:

- Solid Work Table
- Back Up Support Frame to keep frame snug against the section during installation
- Torque Limited Screw Gun

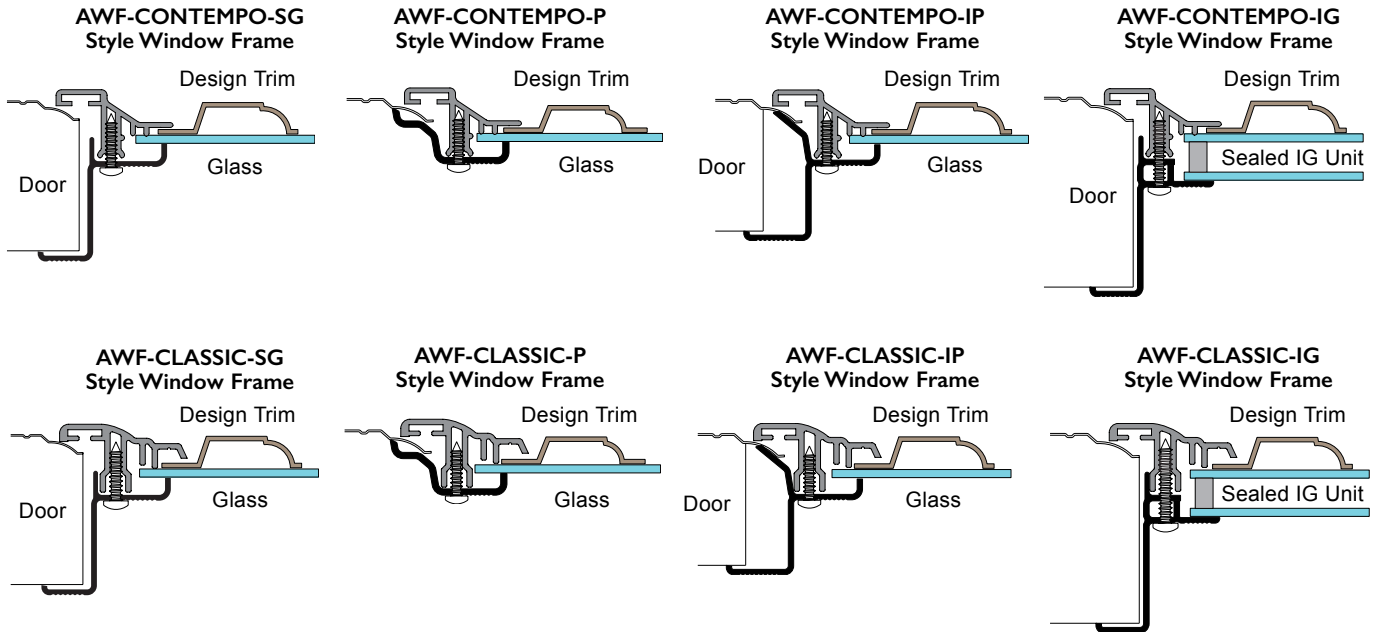
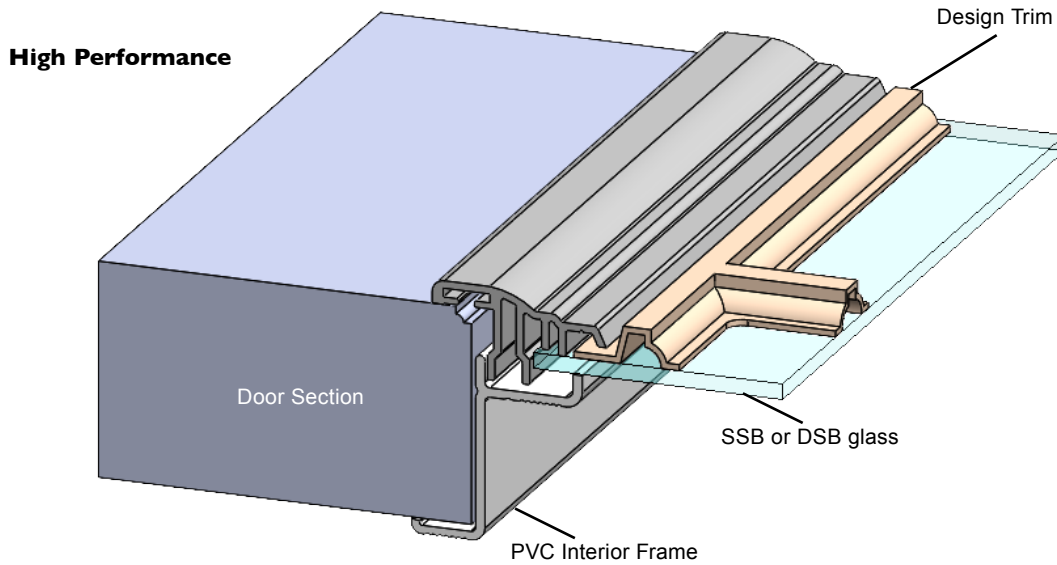

Above illustrations are only representative of actual designs. Actual designs may vary between sizes and manufacturers. The above designs are covered by one or more U.S. Patents. Other U.S. patent applications are pending.

Amarr Window Frames

Short Panel Window Frames

HWF-1 - Screw together short panel window frame

Long Panel Window Frames

HWF-3 - Screw together long panel window frame

Can be used for non insulated, vinyl back or steel back insulated doors
 All frames are supplied without glass
 All window frames are made to accept Stylecraft™ or Styleline™ Design Trim

All frames and design trim available in the following colors:

- White
- Desert Tan
- Walnut
- Brown
- Bronze
- Mahogany
- Almond
- Grey
- Black
- Sandstone
- Green
- Oak

The following information is necessary for your customer service representative to determine the proper window frame and/or design trim best suited for your application:

- Glass size, cut out size, or trim size
- Whether the door is a short panel or long panel
- The make and/or model of the garage door
- Manufacturer's factory door color (if available)

Stock	Description
HWF	Exterior Frame Short Panel
3AMD11A0	HWF-1AM Exterior White Window Frame - Amarr
	Exterior Frame Long Panel
3AMD13A0	HWF-3AM Exterior White Window Frame- Amarr
	Interior Frame Short Panel
3AMD21A9	HWF-1AM/P SG Interior Window Frame - Amarr
3AMF21A9	HWF-1AM/IP SG Interior Window Frame - Amarr
3AMJ21K9	HWF-1AM/138 SG Interior Window Frame - Amarr
3AMJ21R9	HWF-1AM/200 SG Interior Window Frame - Amarr
3AMK21K9	HWF-1AM/138 IG Interior Window Frame - Amarr
3AMK21R9	HWF-1AM/200 IG Interior Window Frame - Amarr
	Interior Frame Long Panel
3AMD23A9	HWF-3AM/P SG Interior Window Frame - Amarr
3AMF23A9	HWF-3AM/IP SG Interior Window Frame - Amarr
3AMJ23K9	HWF-3AM/138 SG Interior Window Frame - Amarr
3AMJ23R9	HWF-3AM/200 SG Interior Window Frame - Amarr
3AMK23K9	HWF-3AM/138 IG Interior Window Frame - Amarr
3AMK23R9	HWF-3AM/200 IG Interior Window Frame - Amarr

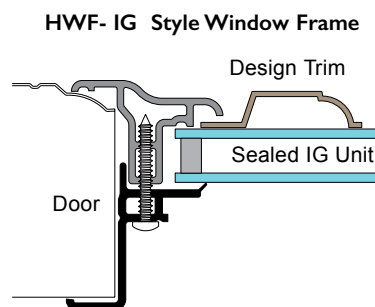
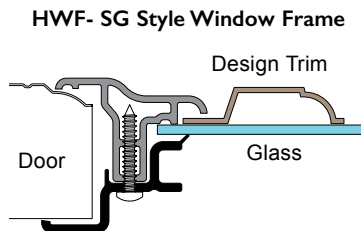
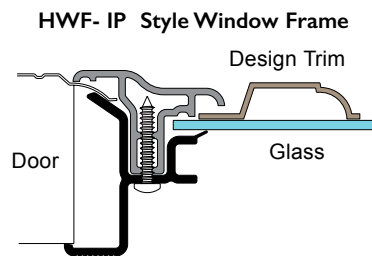
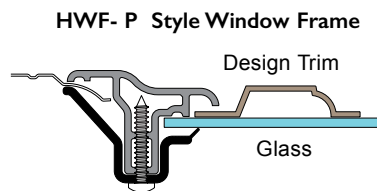

Above illustrations are only representative of actual designs. Actual designs may vary between sizes and manufacturers. The above designs are covered by one or more U.S. Patents. Other U.S. patent applications are pending

CHI Window Frames

Short Panel Window Frames

- **HRF-1** - Screw together short panel window frame
- **SWF-1** - Screw together short panel window frame

Long Panel Window Frames

- **HRF-3** - Screw together long panel window frame
- **SWF-3** - Screw together long panel window frame
- Can be used for non insulated, vinyl back or steel back insulated doors
- All frames are supplied without glass
- All window frames are made to accept Stylecraft™ or Styleline™ Design Trim

All frames and design trim available in the following colors:

- White
- Brown
- Almond
- Sandstone
- Desert Tan
- Black

The following information is necessary for your customer service representative to determine the proper window frame and/or design trim best suited for your application:

- Glass size, cut out size, or trim size
- Whether the door is a short panel or long panel
- The make and/or model of the garage door
- Manufacturer's factory door color (if available)

Stock	Description
HRF	
Exterior Frame Short Panel	
4CHD11A0	HRF-1CH Exterior White Window Frame- CHI
Exterior Frame Long Panel	
4CHD13A0	HRF-3CH Exterior White Window Frame-CHI
Interior Frame Short Panel	
4CHD21A9	HRF-1CH/P SG Interior Window Frame - CHI
4CHF21A9	HRF-1CH/IP SG Interior Window Frame - CHI
4CHJ21P9	HRF-1CH/178 SG Interior Window Frame - CHI
4CHK21P9	HRF-1CH/178 IG Interior Window Frame - CHI
Interior Frame Long Panel	
4CHD23A9	HRF-3CH/P SG Interior Window Frame - CHI
4CHF23A9	HRF-3CH/IP SG Interior Window Frame - CHI
4CHJ23P9	HRF-3CH/178 SG Interior Window Frame - CHI
4CHK23P9	HRF-3CH/178 IG Interior Window Frame - CHI
SWF	
Exterior Frame Short Panel	
3CH511A0	SWF-1CH Exterior White Window Frame- CHI
Exterior Frame Long Panel	
3CH513A0	SWF-3CH Exterior White Window Frame-CHI
Interior Frame Short Panel	
3CH521A9	SWF-1CH/P SG Interior Window Frame - CHI
3CH621E9	SWF-1CH/IP SG Interior Window Frame - CHI
3CH621P9	SWF-1CH/178 SG Interior Window Frame - CHI
3CH721P9	SWF-1CH/178 IG Interior Window Frame - CHI
Interior Frame Long Panel	
3CH523A9	SWF-3CH/P SG Interior Window Frame - CHI
3CH623E9	SWF-3CH/IP SG Interior Window Frame - CHI
3CH623P9	SWF-3CH/178 SG Interior Window Frame - CHI
3CH723P9	SWF-3CH/178 IG Interior Window Frame - CHI

HRF- P Style Window Frame

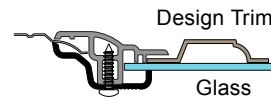

HRF- IP Style Window Frame

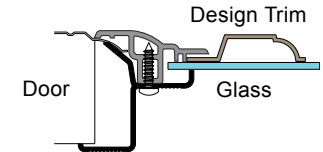

HRF- SG Style Window Frame

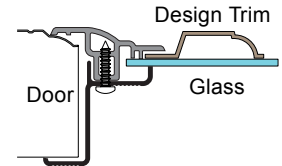

HRF- IG Style Window Frame

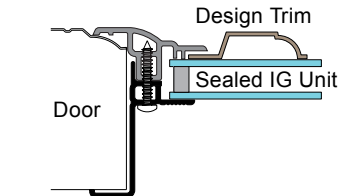

SWF- P Style Window Frame

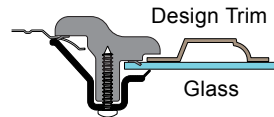

SWF- IP Style Window Frame

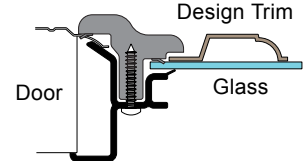

SWF- SG Style Window Frame

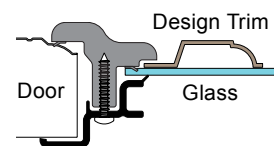

SWF- IG Style Window Frame

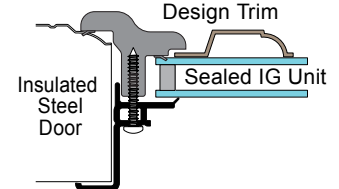

Above illustrations are only representative of actual designs. Actual designs may vary between sizes and manufacturers. The above designs are covered by one or more U.S. Patents. Other U.S. patent applications are pending.

Direct Dial: (817) 834-7300

Clopay Window Frames

Short Panel Window Frames

- **SWF-1** - Screw together short panel window frame

Long Panel Window Frames

- **SWF-3** - Screw together long panel window frame
- Can be used for non insulated, vinyl back or steel back insulated doors
- All frames are supplied without glass
- All window frames are made to accept Stylecraft™ or Styleline™ Design Trim

All frames and design trim available in the following colors:

- White
- Sandstone
- Brown
- Desert Tan
- Almond
- Black

The following information is necessary for your customer service representative to determine the proper window frame and/or design trim best suited for your application:

- Glass size, cut out size, or trim size
- Whether the door is a short panel or long panel
- The make and/or model of the garage door
- Manufacturer's factory door color (if available)

Stock	Description
SWF	Exterior Frame Short Panel
3CL511A0	SWF-1CL Exterior White Window Frame- Clopay
	Exterior Frame Long Panel
3CL513A0	SWF-3CL Exterior White Window Frame-Clopay
	Interior Frame Short Panel
3CL521A9	SWF-1CL/P SG Interior Window Frame - Clopay
3CL321E9	SWF-1CL/IP SG Interior Window Frame - Clopay
3CL621K9	SWF-1CL/138 SG Interior Window Frame - Clopay
3CL721K9	SWF-1CL/138 IG Interior Window Frame - Clopay
3CL621N9	SWF-1CL/134 SG Interior Window Frame - Clopay
3CL721N9	SWF-1CL/134 IG Interior Window Frame - Clopay
	Interior Frame Long Panel
3CL523A9	SWF-3CL/P SG Interior Window Frame - Clopay
3CL323E9	SWF-3CL/IP SG Interior Window Frame - Clopay
3CL623K9	SWF-3CL/138 SG Interior Window Frame - Clopay
3CL723K9	SWF-3CL/138 IG Interior Window Frame - Clopay
3CL623N9	SWF-3CL/134 SG Interior Window Frame - Clopay
3CL723N9	SWF-3CL/134 IG Interior Window Frame - Clopay

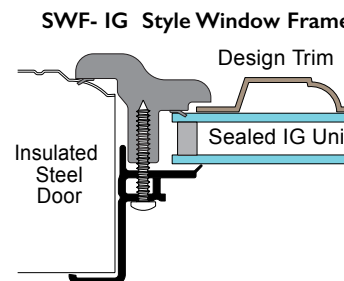
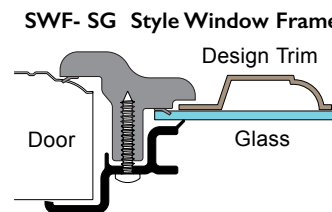
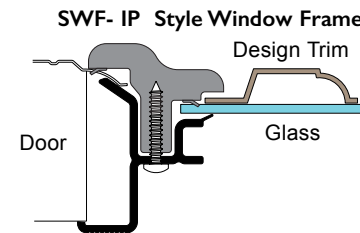
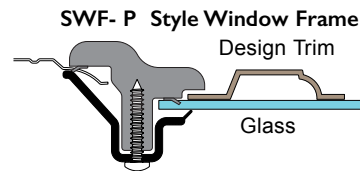

Above illustrations are only representative of actual designs. Actual designs may vary between sizes and manufacturers. The above designs are covered by one or more U.S. Patents. Other U.S. patent applications are pending.

Email: sales@natdoor.com



Delden Window Frames

Short Panel Window Frames

HWF-1 - Screw together short panel window frame

Long Panel Window Frames

HWF-3 - Screw together long panel window frame

Can be used for non insulated, vinyl back or steel back insulated doors
 All frames are supplied without glass
 All window frames are made to accept Stylecraft™ or Styleline™ Design Trim

All frames and design trim available in the following colors:

- White
- Desert Tan
- Walnut
- Brown
- Bronze
- Mahogany
- Almond
- Grey
- Black
- Sandstone
- Green
- Oak

The following information is necessary for your customer service representative to determine the proper window frame and/or design trim best suited for your application:

- Glass size, cut out size, or trim size
- Whether the door is a short panel or long panel
- The make and/or model of the garage door
- Manufacturer's factory door color (if available)

Stock	Description
HWF	Exterior Frame Short Panel
3AMD11A0	HWF-1AM Exterior White Window Frame - Amarr
	Exterior Frame Long Panel
3AMD13A0	HWF-3AM Exterior White Window Frame- Amarr
	Interior Frame Short Panel
3AMD21A9	HWF-1AM/P SG Interior Window Frame - Amarr
3AMF21A9	HWF-1AM/IP SG Interior Window Frame - Amarr
3AMJ21K9	HWF-1AM/138 SG Interior Window Frame - Amarr
3AMJ21R9	HWF-1AM/200 SG Interior Window Frame - Amarr
3AMK21K9	HWF-1AM/138 IG Interior Window Frame - Amarr
3AMK21R9	HWF-1AM/200 IG Interior Window Frame - Amarr
	Interior Frame Long Panel
3AMD23A9	HWF-3AM/P SG Interior Window Frame - Amarr
3AMF23A9	HWF-3AM/IP SG Interior Window Frame - Amarr
3AMJ23K9	HWF-3AM/138 SG Interior Window Frame - Amarr
3AMJ23R9	HWF-3AM/200 SG Interior Window Frame - Amarr
3AMK23K9	HWF-3AM/138 IG Interior Window Frame - Amarr
3AMK23R9	HWF-3AM/200 IG Interior Window Frame - Amarr

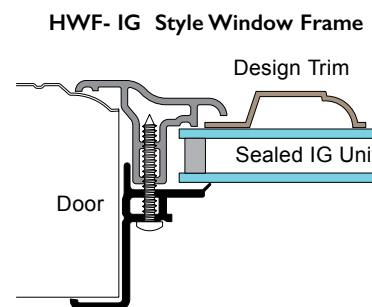
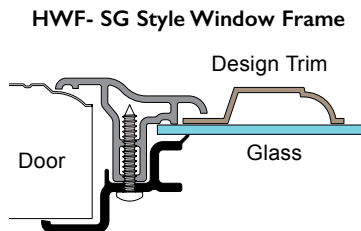
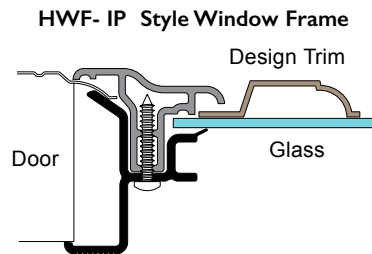
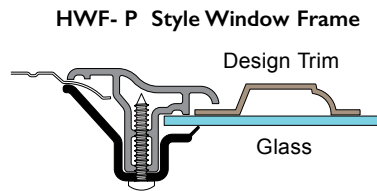

Above illustrations are only representative of actual designs. Actual designs may vary between sizes and manufacturers. The above designs are covered by one or more U.S. Patents. Other U.S. patent applications are pending

Direct Dial: (817) 834-7300

DoorLink Window Frames

Short Panel Window Frames

- **IMF-1** - Screw together short panel window frame

Ranch Panel Window Frames

- **IMF-3** - Screw together long panel window frame
- **HRF-3** - Screw together long panel window frame

Carriage House Window Frames

- **IMF-4216** - Screw together long panel window frame
- **HRF-4216** - Screw together long panel window frame

Long Panel Window Frames

- **IMF-4416** - Screw together long panel window frame
- **HRF-4416** - Screw together long panel window frame
- Can be used for non insulated, vinyl back or steel back insulated doors
- All frames are supplied without glass
- All window frames are made to accept Stylecraft™ or Styleline™ Design Trim

All frames and design trim available in the following colors:

- White
- Brown
- Almond
- Sandstone
- Grey
- Desert Tan
- Black
- Plank Cypress
- Walnut
- Driftwood
- Plank Driftwood

The following information is necessary for your customer service representative to determine the proper window frame and/or design trim best suited for your application:

- Glass size, cut out size, or trim size
- Whether the door is a short panel or long panel
- The make and/or model of the garage door
- Manufacturer's factory door color (if available)

Stock	Description
IMF	Exterior Frame Short Panel
6DL611A0	IMF-1DL Exterior White Window Frame - DoorLink
	Exterior Frame Ranch Panel
4DL613A0	IMF-3DL Exterior White Window Frame - DoorLink
	Exterior Frame Carriage House
4DL61BA0	IMF-4216DL Exterior White Window Frame - DoorLink
	Exterior Frame Long Panel
4DL61CA0	IMF-4416DL Exterior White Window Frame - DoorLink
	Interior Frame Short Panel
6DL621A9	IMF-1DL/P SG Interior Window Frame - DoorLink
6DL621C9	IMF-1DL/IP SG Interior Window Frame - DoorLink
6DL421P9	IMF-1DL178 SG Interior Window Frame - DoorLink
	Interior Frame Ranch Panel
6DL623A9	IMF-3DL/P SG Interior Window Frame - DoorLink
6DL623C9	IMF-3DL/IP SG Interior Window Frame - DoorLink
6DL423P9	IMF-3DL178 SG Interior Window Frame - DoorLink
	Interior Frame Carriage House
6DL62BA9	IMF-4216DL/P SG Interior Window Frame - DoorLink
6DL62BC9	IMF-4216DL/IP SG Interior Window Frame - DoorLink
6DL42BP9	IMF-4216DL178 SG Interior Window Frame - DoorLink
	Interior Frame Long Panel
6DL62CA9	IMF-4416DL/P SG Interior Window Frame - DoorLink
6DL62CC9	IMF-4416DL/IP SG Interior Window Frame - DoorLink
6DL42CP9	IMF-4416DL178 SG Interior Window Frame - DoorLink

Stock	Description
HRF	Exterior Frame Ranch Panel
4DLD13A0	HRF-3DL Exterior White Window Frame - DoorLink
	Exterior Frame Carriage House
4DLD1BA0	HRF-4216DL Exterior White Window Frame - DoorLink
	Exterior Frame Long Panel
4DLD1CA0	HRF-4416DL Exterior White Window Frame - DoorLink
	Interior Frame Short Panel
4DLK21P9	HRF-1DL178 IG Interior Window Frame - DoorLink
	Interior Frame Ranch Panel
4DLD23A9	HRF-3DL/P SG Interior Window Frame - DoorLink
4DLF23A9	HRF-3DL/IP SG Interior Window Frame - DoorLink
4DLJ23M9	HRF-3DL158 SG Interior Window Frame - DoorLink
4DLJ23P9	HRF-3DL178 SG Interior Window Frame - DoorLink
	Interior Frame Carriage House
4DLD2BA9	HRF-4216DL/P SG Interior Window Frame - DoorLink
4DLF2BA9	HRF-4216DL/IP SG Interior Window Frame - DoorLink
4DLJ2BP9	HRF-4216DL178 SG Interior Window Frame - DoorLink
4DLK2BP9	HRF-4216DL178 IG Interior Window Frame - DoorLink
	Interior Frame Long Panel
4DLD2CA9	HRF-4416DL/P SG Interior Window Frame - DoorLink
4DLF2CA9	HRF-4416DL/IP SG Interior Window Frame - DoorLink
4DLJ2CP9	HRF-4416DL178 SG Interior Window Frame - DoorLink
4DLK2CP9	HRF-4416DL178 IG Interior Window Frame - DoorLink

HRF- P Style Window Frame Design Trim

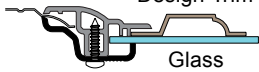

HRF- IP Style Window Frame Design Trim

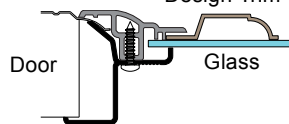

HRF- SG Style Window Frame Design Trim

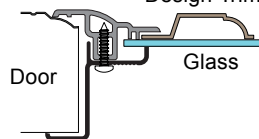

HRF- IG Style Window Frame Design Trim

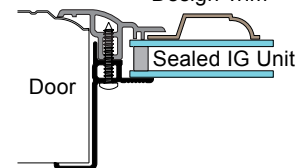

IMF- P Style Window Frame Design Trim

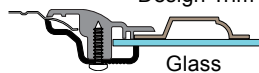

IMF- IP Style Window Frame Design Trim

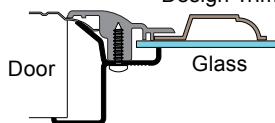

IMF- SG Style Window Frame Design Trim

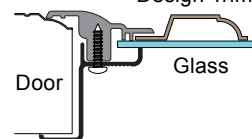

Above illustrations are only representative of actual designs. Actual designs may vary between sizes and manufacturers. The above designs are covered by one or more U.S. Patents. Other U.S. patent applications are pending.

Email: sales@natdoor.com



First United Door Technologies Window Frames

Short Panel Window Frames

- **SRF-1** - Screw together short panel window frame

Long Panel Window Frames

- **SRF-3** - Screw together long panel window frame
- Can be used for non insulated, vinyl back or steel back insulated doors
- All frames are supplied without glass
- All window frames are made to accept Stylecraft™ or Styleline™ Design Trim

All frames and design trim available in the following colors:

- White
- Almond
- Sandstone

The following information is necessary for your customer service representative to determine the proper window frame and/or design trim best suited for your application:

- Glass size, cut out size, or trim size
- Whether the door is a short panel or long panel
- The make and/or model of the garage door
- Manufacturer's factory door color (if available)

Stock	Description
SRF	
	Exterior Frame Short Panel
4UD411A0	SRF-1UD Exterior White Window Frame - United Door
	Exterior Frame Long Panel
4UD413A0	SRF-3UD Exterior White Window Frame - United Door
	Interior Frame Short Panel
4UD421A9	SRF-1UD/P Interior Window Frame - United Door
4UD521D9	SRF-1UD/IP Interior Window Frame - United Door
4UD721R9	SRF-1UD/200 Interior Window Frame - United Door
	Interior Frame Long Panel
4UD423A9	SRF-3UD/P Interior Window Frame - United Door
4UD523D9	SRF-3UD/IP Interior Window Frame - United Door
4UD723R9	SRF-3UD/200 Interior Window Frame - United Door

SRF- P Style Window Frame

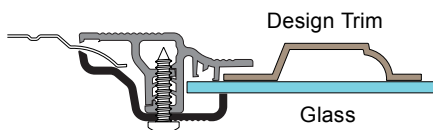

SRF- IP Style Window Frame

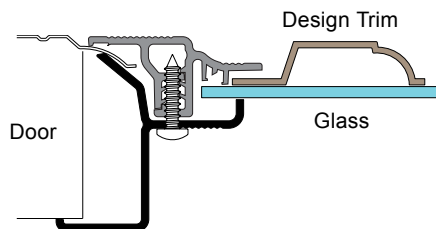

SRF- SG Style Window Frame

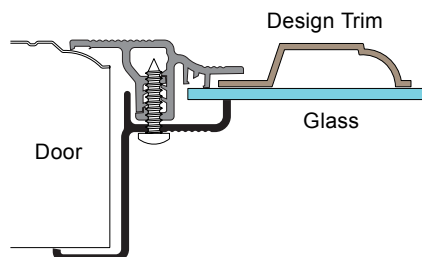

Above illustrations are only representative of actual designs. Actual designs may vary between sizes and manufacturers. The above designs are covered by one or more U.S. Patents. Other U.S. patent applications are pending.

Direct Dial: (817) 834-7300

General Door Window Frames

Short Panel Window Frames

- **HWF-1** - Screw together short panel window frame
- **SPWF-1** - Snap together short panel window frame
- **SWF-1** - Snap together short panel window frame

Long Panel Window Frames

- **HWF-3** - Screw together long panel window frame
 - **SPWF-3** - Snap together long panel window frame
 - **SWF-3** - Snap together long panel window frame
- Can be used for non insulated, vinyl back or steel back insulated doors
- All frames are supplied without glass
- All window frames are made to accept Stylecraft™ or Styleline™ Design Trim

All frames and design trim available in the following colors:

- White
- Almond
- Brown
- Sandstone

The following information is necessary for your customer service representative to determine the proper window frame and/or design trim best suited for your application:

- Glass size, cut out size, or trim size
- Whether the door is a short panel or long panel
- The make and/or model of the garage door
- Manufacturer's factory door color (if available)

Stock	Description
HWF	Exterior Frame Short Panel
3GED11A0	HWF-1GE Exterior White Window Frame - General
	Exterior Frame Long Panel
3GED13A0	HWF-3GE Exterior White Window Frame - General
	Interior Frame Short Panel
3GED21A9	HWF-1GE/P SG Interior Window Frame - General
3GEJ21K9	HWF-1GE/138 SG Interior Window Frame - General
3GEK21K9	HWF-1GE/138 IG Interior Window Frame - General
3GED22A9	HWF-2GE/P SG Interior Window Frame - General
3GEJ22K9	HWF-2GE/138 SG Interior Window Frame - General
3GEK22K9	HWF-2GE/138 IG Interior Window Frame - General
	Interior Frame Long Panel
3GED23A9	HWF-3GE/P SG Interior Window Frame - General
3GEJ23K9	HWF-3GE/138 SG Interior Window Frame - General
3GEK23K9	HWF-3GE/138 IG Interior Window Frame - General
3GED26A9	HWF-12GE/P SG Interior Window Frame - General
3GEJ26K9	HWF-12GE/138 SG Interior Window Frame - General
3GEK26K9	HWF-12GE/138 IG Interior Window Frame - General
SPWF	Snap Together Frame Short Panel
3GE8A0	SPWF-1GE SG White Window Frame - General
3GE8B0	SPWF-2GE SG White Window Frame - General
SWF	Complete Frame Short Panel
3GE6A0	SWF-1GE SG White Window Frame - General
3GE7A0	SWF-1GE IG White Window Frame - General
3GE6B0	SWF-2GE SG White Window Frame - General
3GE7B0	SWF-2GE IG White Window Frame - General
	Complete Frame Long Panel
3GE6C0	SWF-3GE SG White Window Frame - General
3GE7C0	SWF-3GE IG White Window Frame - General
3GE6E0	SWF-12GE SG White Window Frame - General
3GE7E0	SWF-12GE IG White Window Frame - General
PIF	Insulation Retainer Frame Short Panel
3GE1A0	PIF-1GE SG White Window Frame - General
3GE1B0	PIF-2GE SG White Window Frame - General
	Insulation Retainer Frame Long Panel
3GE1C0	PIF-3GE SG White Window Frame - General
3GE1E0	PIF-12GE SG White Window Frame - General

HWF- P Style Window Frame

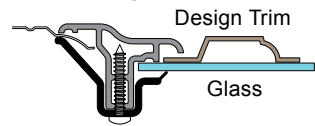

HWF- IP Style Window Frame

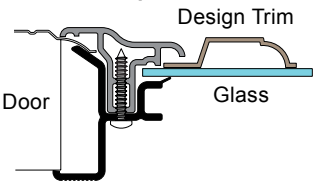

HWF- SG Style Window Frame

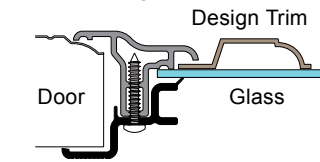

HWF- IG Style Window Frame

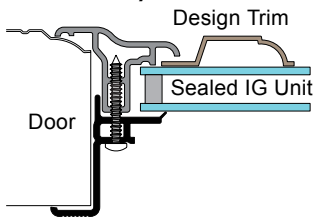

SWF- P Style Window Frame

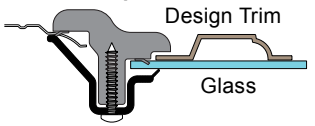

SWF- IP Style Window Frame

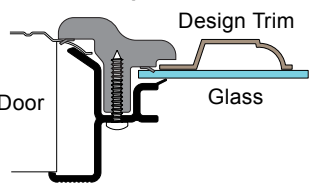

SWF- SG Style Window Frame

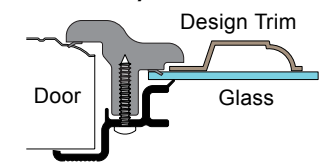

SWF- IG Style Window Frame

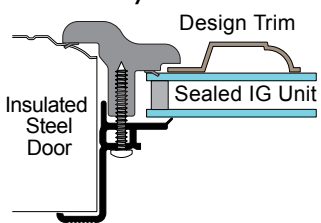

SPWF- PIF Style Window Frame

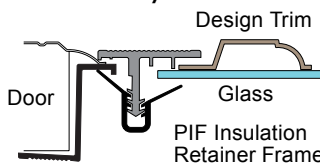

Above illustrations are only representative of actual designs. Actual designs may vary between sizes and manufacturers. The above designs are covered by one or more U.S. Patents. Other U.S. patent applications are pending

Haas Window Frames

Short Panel Window Frames

- **SWF-1** - Screw together short panel window frame

Long Panel Window Frames

- **SWF-3** - Screw together long panel window frame
- Can be used for non insulated, vinyl back or steel back insulated doors
- All frames are supplied without glass
- All window frames are made to accept Stylecraft™ or Styleline™ Design Trim

Stock	Description
SWF	
	Exterior Frame Short Panel
3HA900	SWF-1HAP Exterior White Window Frame - Haas
3HA600	SWF-1HA Exterior White Window Frame - Haas
	Exterior Frame Long Panel
3HA610	SWF-3HA Exterior White Window Frame - Haas
	Interior Frame Short Panel
3HA950	SWF-1HAP Interior Window Frame - Haas
3HA960	SWF-1HAP/IP SG Interior Window Frame - Haas
3HA650	SWF-1HA138 SG Interior Window Frame - Haas
3HA670	SWF-1HA138 IG Interior Window Frame - Haas
3HA651	SWF-1HA134 SG Interior Window Frame - Haas
3HA671	SWF-1HA134 IG Interior Window Frame - Haas
	Interior Frame Long Panel
3HA970	SWF-3HAP Interior Window Frame - Haas
3HA980	SWF-3HAP/IP SG Interior Window Frame - Haas
3HA660	SWF-3HA138 SG Interior Window Frame - Haas
3HA680	SWF-3HA138 IG Interior Window Frame - Haas
3HA661	SWF-3HA134 SG Interior Window Frame - Haas
3HA681	SWF-3HA134 IG Interior Window Frame - Haas
3HA662	SWF-3HA200 SG Interior Window Frame - Haas
3HA682	SWF-3HA200 IG Interior Window Frame - Haas

Frames and design trim available in the following colors:

- White
- Brown
- Almond
- Sandstone

The following information is necessary for your customer service representative to determine the proper window frame and/or design trim best suited for your application:

- The make and/or model of the garage door
- Whether the door is a short panel or long panel
- Manufacturer's factory door color (if available)
- Glass size, cut out size, or trim size

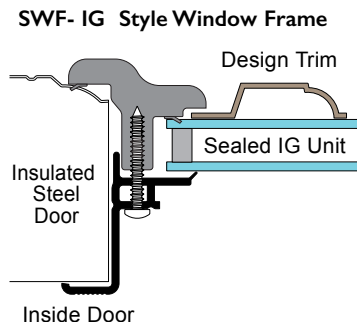
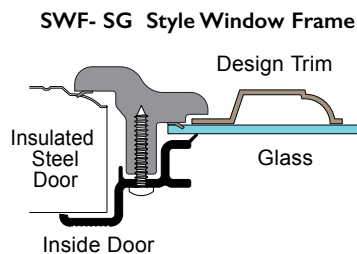
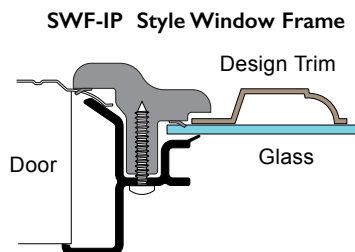
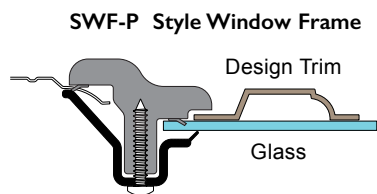

Above illustrations are only representative of actual designs. Actual designs may vary between sizes and manufacturers. The above designs are covered by one or more U.S. Patents. Other U.S. patent applications are pending.

Mid-America Window Frames

Short Panel Window Frames

- **IMS-1** - Screw together short panel window frame

Long Panel Window Frames

- **HRF-4116** - Screw together long panel window frame
- Can be used for non insulated, vinyl back or steel back insulated doors
- All frames are supplied without glass
- All window frames are made to accept Stylecraft™ or Styleline™ Design Trim

All frames and design trim available in the following colors:

- White
- Brown
- Almond
- Sandstone
- Desert Tan
- Bronze
- Black
- Cherrywood

The following information is necessary for your customer service representative to determine the proper window frame and/or design trim best suited for your application:

- Glass size, cut out size, or trim size
- Whether the door is a short panel or long panel
- The make and/or model of the garage door
- Manufacturer's factory door color (if available)

Stock	Description
IMS	Exterior Frame Short Panel
6MD711A0	IMS-1MD Exterior White Window Frame - Mid-America
HRF	Exterior Frame Long Panel
4MDD1BA0	HRF-4116MD Exterior White Window Frame - Mid-America
	Interior Frame Short Panel
4MDD21A9	HRF-1MD/P Interior Window Frame - Mid-America
4MDF21A9	HRF-1MD/IP Interior Window Frame - Mid-America
4MDJ21P9	HRF-1MD/178 SG Interior Window Frame - Mid-America
4MDK21P9	HRF-1MD/178 IG Interior Window Frame - Mid-America
	Interior Frame Long Panel
4MDD2BA9	HRF-4116MD/P Interior Window Frame - Mid-America
4MDF2BA9	HRF-4116MD/IP Interior Window Frame - Mid-America
4MDJ2BP9	HRF-4116MD/178 SG Interior Window Frame - Mid-America
4MDK2BP9	HRF-4116MD/178 IG Interior Window Frame - Mid-America
4MDJ2BR9	HRF-4116MD/200 SG Interior Window Frame - Mid-America
4MDK2BR9	HRF-4116MD/200 IG Interior Window Frame - Mid-America

IMS- SG Style Window Frame

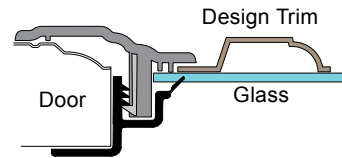

HRF- P Style Window Frame

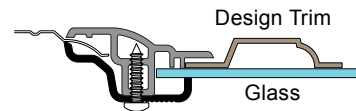

HRF- IP Style Window Frame

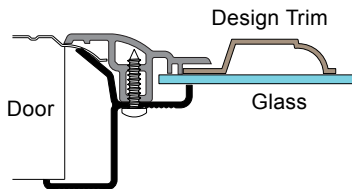

HRF- SG Style Window Frame

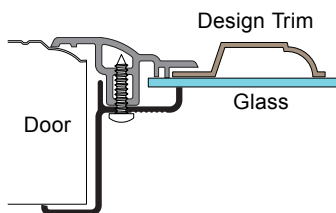

HRF- IG Style Window Frame

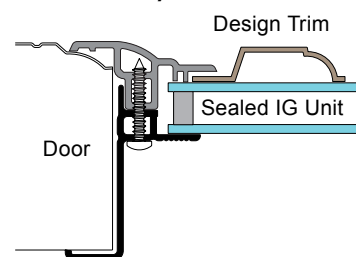

Above illustrations are only representative of actual designs. Actual designs may vary between sizes and manufacturers. The above designs are covered by one or more U.S. Patents. Other U.S. patent applications are pending

Overhead Door Window Frames

Short Panel Window Frames

- **IMF-1** - Snap together short panel window frame
- **IMS-1** - Snap together short panel window frame

Long Panel Window Frames

- **SWF-3** - Screw together long panel window frame
- Can be used for non insulated, vinyl back or steel back insulated doors
- All frames are supplied without glass
- All window frames are made to accept Stylecraft™ or Styleline™ Design Trim
- Some colors not available for certain profiles

Frames and design trim available in the following colors:

- White
- Desert Tan
- Walnut
- Brown
- Bronze
- Mission Oak
- Almond
- Grey
- Black
- Sandstone
- Green
- Golden Oak

The following information is necessary for your customer service representative to determine the proper window frame and/or design trim best suited for your application:

- Glass size, cut out size, or trim size
- Whether the door is a short panel or long panel
- The make and/or model of the garage door
- Manufacturer's factory door color (if available)

Stock	Description
IMF	Exterior Frame Short Panel
4OD500-170	IMF-10D Exterior White Window Frame - Overhead
	Interior Frame Short Panel
4OD511	IMF-10D311 Interior Window Frame - Overhead
4OD513	IMF-10D313 Interior Window Frame - Overhead
IMS	Exterior Frame Short Panel
4OD800	IMS-10D Exterior White Window Frame - Overhead
	Interior Frame Short Panel
4OD842	IMS-10D/P SG Interior Window Frame - Overhead 170
4OD810	IMS-10D/100 SG Interior Window Frame - Overhead
4OD820	IMS-10D/138 SG Interior Window Frame - Overhead
4OD821	IMS-10D/138 IG Interior Window Frame - Overhead
4OD830	IMS-10D/150 SG Interior Window Frame - Overhead
4OD840	IMS-10D/200 SG Interior Window Frame - Overhead
4OD841	IMS-10D/200 IG Interior Window Frame - Overhead
SWF	Long Panel Frame
3OH6C0	SWF-3OH399 SG White Window Frame - Overhead 399
	Long Panel 171 Series Frame
3OD6C0-171	SWF-3OD/P 171 SG White Window Frame - Overhead
	Long Panel 181 Series Frame
3OD3C0-181	SWF-3OD/IP 181 SG White Window Frame - Overhead

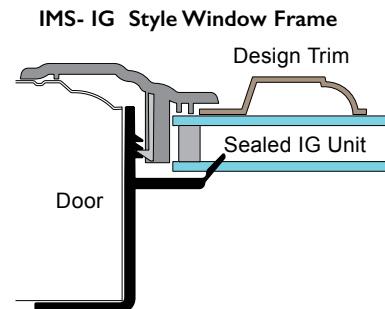
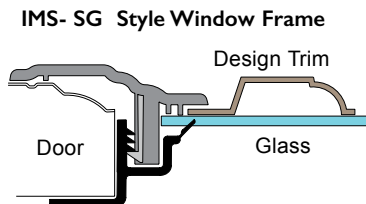
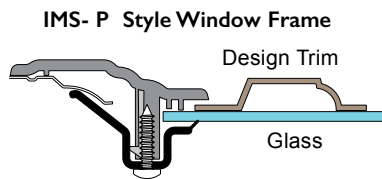
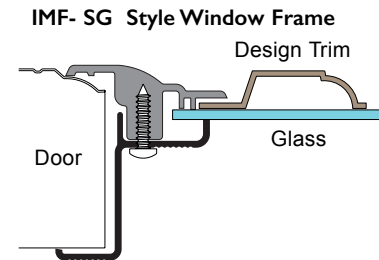
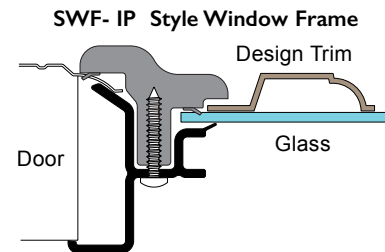
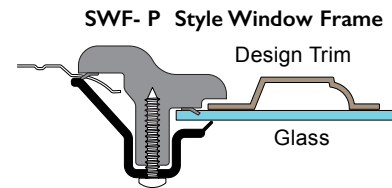

Above illustrations are only representative of actual designs. Actual designs may vary between sizes and manufacturers. The above designs are covered by one or more U.S. Patents. Other U.S. patent applications are pending.

Richards-Wilcox Window Frames

Short Panel Window Frames

- **SWF-I** - Screw together short panel window frame

Long Panel Window Frames

- **SWF-3** - Screw together long panel window frame
- Can be used for non insulated, vinyl back or steel back insulated doors
- All frames are supplied without glass
- All window frames are made to accept Stylecraft™ or Styleline™ Design Trim

Frames and design trim available in the following colors:

- White
- Sandstone
- Brown
- Grey
- Almond

The following information is necessary for your customer service representative to determine the proper window frame and/or design trim best suited for your application:

- The make and/or model of the garage door
- Whether the door is a short panel or long panel
- Manufacturer's factory door color (if available)
- Glass size, cut out size, or trim size

Stock	Description
SWF	
	Exterior Frame Short Panel
3RW511A0	SWF-1RW Exterior White Window Frame - Richards-Wilcox
	Exterior Frame Long Panel
3RW513A0	SWF-3RW Exterior White Window Frame - Richards-Wilcox
	Interior Frame Short Panel
3RW621G9	SWF-1RW/116 SG Interior Window Frame - Richards-Wilcox
3RW721G9	SWF-1RW/116 IG Interior Window Frame - Richards-Wilcox
3RW721M9	SWF-1RW/158 IG Interior Window Frame - Richards-Wilcox
	Interior Frame Long Panel
3RW723M9	SWF-3RW/158 IG Interior Window Frame - Richards-Wilcox
3RW623R9	SWF-3RW/200 SG Interior Window Frame - Richards-Wilcox
3RW723R9	SWF-3RW/200 IG Interior Window Frame - Richards-Wilcox

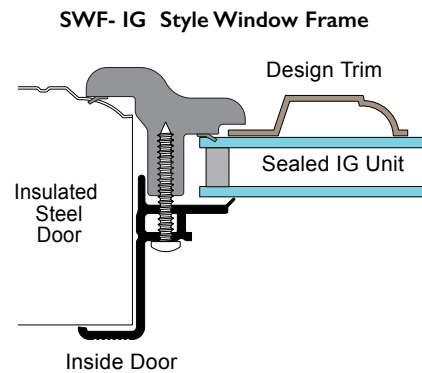
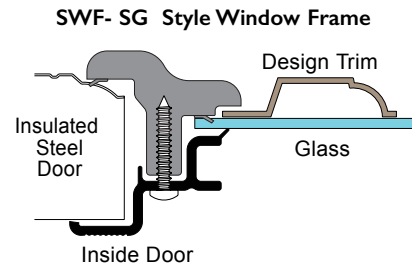

Above illustrations are only representative of actual designs. Actual designs may vary between sizes and manufacturers. The above designs are covered by one or more U.S. Patents. Other U.S. patent applications are pending.

Windsor Window Frames

Short Panel Window Frames

- **SPWF-1** - Snap together short panel window frame
- **SRF-1** - Screw together short panel window frame

Long Panel Window Frames

- **SPWF-3** - Snap together long panel window frame
- **SRF-3** - Screw together long panel window frame
- Can be used for non insulated, vinyl back or steel back insulated doors
- All frames are supplied without glass
- All window frames are made to accept Stylecraft™ or Styleline™ Design Trim

All frames and design trim available in the following colors:

- White
- Sandstone
- Brown
- Desert Tan
- Almond
- Grey

The following information is necessary for your customer service representative to determine the proper window frame and/or design trim best suited for your application:

- Glass size, cut out size, or trim size
- Whether the door is a short panel or long panel
- The make and/or model of the garage door
- Manufacturer's factory door color (if available)

Stock	Description
SPWF	
Short Panel Frame	
3WI8A0	SPWF-1WI White Window Frame - Windsor
Long Panel Frame	
3WI8C0	SPWF-3WI White Window Frame - Windsor
3WI8D0	SPWF-6WI White Window Frame - Windsor
SPWF-FC	
Short Panel Foam Core Frame	
3WI2A0	SPWF-1WIFC White Window Frame - Windsor
Long Panel Foam Core Frame	
3WI2C0	SPWF-3WIFC White Window Frame - Windsor
3WI2D0	SPWF-6WIFC White Window Frame - Windsor
SRF	
Exterior Frame Short Panel	
4WI411A0	SRF-1WI Exterior White Window Frame - Windsor
Exterior Frame Long Panel	
4WI413A0	SRF-3WI Exterior White Window Frame - Windsor
Interior Frame Short Panel	
4WI421A9	SRF-1WI/P Interior Window Frame - Windsor
4WI521A9	SRF-1WI/IP Interior Window Frame - Windsor
4WI721K9	SRF-1WI/138 SG Interior Window Frame - Windsor
4WI821K9	SRF-1WI/138 IG Interior Window Frame - Windsor
4WI721R9	SRF-1WI/200 SG Interior Window Frame - Windsor
4WI821R9	SRF-1WI/200 IG Interior Window Frame - Windsor
Interior Frame Long Panel	
4WI423A9	SRF-3WI/P Interior Window Frame - Windsor
4WI523A9	SRF-3WI/IP Interior Window Frame - Windsor
4WI723K9	SRF-3WI/138 SG Interior Window Frame - Windsor
4WI823K9	SRF-3WI/138 IG Interior Window Frame - Windsor
4WI723R9	SRF-3WI/200 SG Interior Window Frame - Windsor
4WI823R9	SRF-3WI/200 IG Interior Window Frame - Windsor
PIF	
Complete Frame Short Panel	
3WI1A0	PIF-1WI Exterior White Window Frame - Windsor
Complete Frame Long Panel	
3WI1C0	PIF-3WI Exterior White Window Frame - Windsor
3WI1D0	PIF-6WI Exterior White Window Frame - Windsor

SPWF Style Window Frame

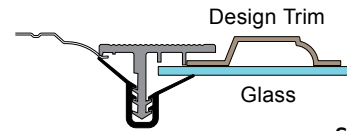

SPWF-PIF Style Window Frame

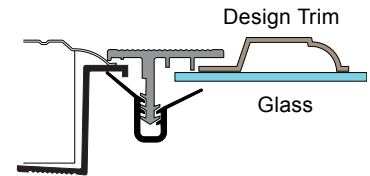

SRF- P Style Window Frame

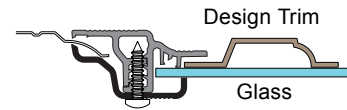

SRF- IP Style Window Frame

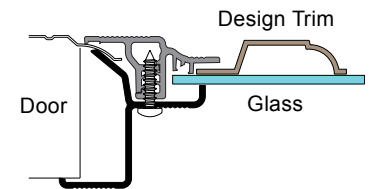

SRF- SG Style Window Frame

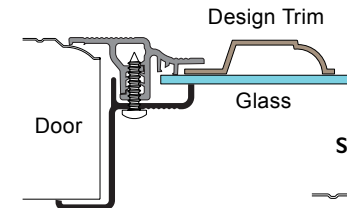

SRF- IG Style Window Frame

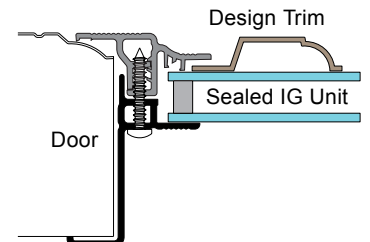

Above illustrations are only representative of actual designs. Actual designs may vary between sizes and manufacturers. The above designs are covered by one or more U.S. Patents. Other U.S. patent applications are pending.

Direct Dial: (817) 834-7300

CONTEMPORARY / CLASSIC SERIES

- Two distinctive designs
- Contemporary frame design with a modern flare
- Classic frame design for a traditional look
- High performance Aluminum PVC interior construction fully caulked / fasteners included screw-together design
- Available fit for Pan, 1", 1-3/8", 1-1/2" 1-3/4" & 2" (DTF*)
- Smooth factory finish White color "in stock" available in most OEM colors
- Standard sizes (see chart) custom size available
- Glass: Clear 1/8" DSB, 1/2" Insulated Glass available
- Custom sizes available upon request
- Custom Stylecraft™ and Styleline™ available upon request

All models and sizes are available for both Contemporary and Classic series frames.
Available for the following flush door thickness.

- Pan, 1", 1-3/8", 1-1/2", 1-5/8", 1-3/4" and 2" (DTF*)
- Glass: Clear 1/8" DSB, 1/2" Insulated glass available

DTF* FRAME OAS	Dimensions (inch)				Glass Size (inch)		Cut-out Size (inch)	
	A**	B**	C	D	WIDTH	HEIGHT	WIDTH	HEIGHT
16X8	13.372	16.343	15.316	16.000	14.362	6.362	15-7/16"	7-7/16"
26X8	23.372	26.346	25.316	26.000	24.362	6.632	25-7/16"	7-7/16"
32X8	29.372	32.346	31.316	32.000	30.362	6.362	31-7/16"	7-7/16"
38X8	35.372	38.346	37.316	38.000	36.362	6.362	37-7/16"	7-7/16"
42X8	39.372	42.346	41.316	42.000	40.362	6.362	41-7/16"	7-7/16"
48X8	45.372	48.346	47.316	48.000	46.362	6.362	47-7/16"	7-7/16"

**For reference purposes only
Custom sizes available upon request

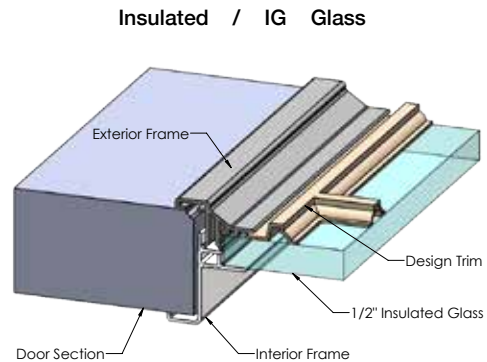
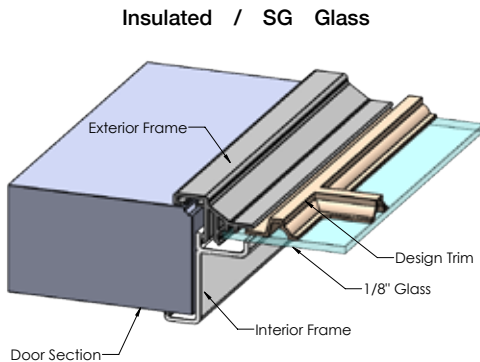
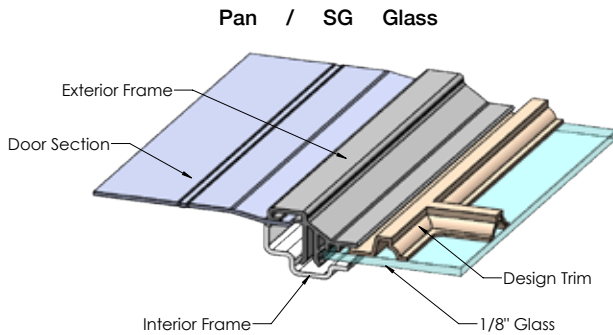

Above illustrations are only representative of actual designs. Actual designs may vary between sizes and manufacturers.
The above designs are covered by one or more U.S. Patents. Other U.S. patent applications are pending

Email: sales@natdoor.com



Carriage Door Window Frames - 13" Height

Typically used on 18", 21", or 24" sections

Frame sizes available

- 17" x 13" Short Panel Door
- 20" x 13" Short Panel Door
- 35" x 13" Long Panel Door
- 38" x 13" Long Panel Door
- 44" x 13" Long Panel Door
- 50" x 13" Long Panel
- IG frames available upon request



Door thickness available:

Pan, IP, 1", 1 3/8", 1 5/8", 1 3/4", 1 7/8" and 2" flush doors

Stock	Description
3CD10A	CFR-1713/P SG White 17 x 13
3CD10B	CFR-1713/IP SG White 17 x 13
3CD12J	CFR-1713/100 SG White 17 x 13
3CD12M	CFR-1713/138 SG White 17 x 13
3CD12P	CFR-1713/158 SG White 17 x 13
3CD12Q	CFR-1713/134 SG White 17 x 13
3CD12R	CFR-1713/178 SG White 17 x 13
3CD12S	CFR-1713/200 SG White 17 x 13
3CD20A	CFR-2013/P SG White 20 x 13
3CD20B	CFR-2013/IP SG White 20 x 13
3CD22J	CFR-2013/100 SG White 20 x 13
3CD22M	CFR-2013/138 SG White 20 x 13
3CD22P	CFR-2013/158 SG White 20 x 13
3CD22Q	CFR-2013/134 SG White 20 x 13
3CD22R	CFR-2013/178 SG White 20 x 13
3CD22S	CFR-2013/200 SG White 20 x 13
3CD40A	CFR-3513/P SG White 35 x 13
3CD40B	CFR-3513/IP SG White 35 x 13
3CD42J	CFR-3513/100 SG White 35 x 13
3CD42M	CFR-3513/138 SG White 35 x 13
3CD42P	CFR-3513/158 SG White 35 x 13
3CD42Q	CFR-3513/134 SG White 35 x 13
3CD42R	CFR-3513/178 SG White 35 x 13
3CD42S	CFR-3513/200 SG White 35 x 13

Stock	Description
3CD50A	CFR-3813/P SG White 38 x 13
3CD50B	CFR-3813/IP SG White 38 x 13
3CD52J	CFR-3813/100 SG White 38 x 13
3CD52M	CFR-3813/138 SG White 38 x 13
3CD52P	CFR-3813/158 SG White 38 x 13
3CD52Q	CFR-3813/134 SG White 38 x 13
3CD52R	CFR-3813/178 SG White 38 x 13
3CD52S	CFR-3813/200 SG White 38 x 13
3CD60A	CFR-4413/P SG White 44 x 13
3CD60B	CFR-4413/IP SG White 44 x 13
3CD62J	CFR-4413/100 SG White 44 x 13
3CD62M	CFR-4413/138 SG White 44 x 13
3CD62P	CFR-4413/158 SG White 44 x 13
3CD62Q	CFR-4413/134 SG White 44 x 13
3CD62R	CFR-4413/178 SG White 44 x 13
3CD62S	CFR-4413/200 SG White 44 x 13
3CD70A	CFR-5013/P SG White 50 x 13
3CD70B	CFR-5013/IP SG White 50 x 13
3CD72J	CFR-5013/100 SG White 50 x 13
3CD72M	CFR-5013/138 SG White 50 x 13
3CD72P	CFR-5013/158 SG White 50 x 13
3CD72Q	CFR-5013/134 SG White 50 x 13
3CD72R	CFR-5013/178 SG White 50 x 13
3CD72S	CFR-5013/200 SG White 50 x 13

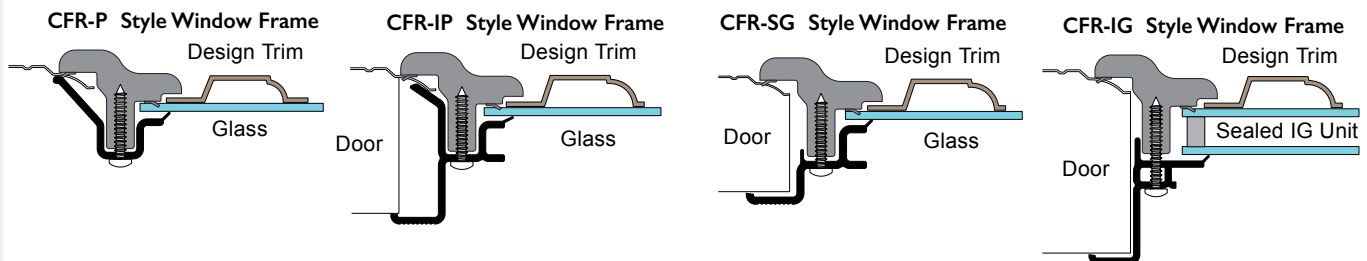

Above illustrations are only representative of actual designs. Actual designs may vary between sizes and manufacturers. The above designs are covered by one or more U.S. Patents. Other U.S. patent applications are pending

Carriage Door Frames - 16" Height

Typically used on 18", 21" or 26" sections

Frame sizes available

- 17" x 16" Short Panel Door
- 20" x 16" Short Panel Door
- 35" x 16" Long Panel Door
- 38" x 16" Long Panel Door
- 44" x 16" Long Panel Door
- 50" x 16" Long Panel Door

- IG frames available upon request.



Door thickness available:

Pan, IP, 1", 1 3/8", 1 5/8", 1 3/4", 1 7/8" and 2" flush doors

Stock	Description
3CD16A	CFR-1716/P SG White 17 x 16
3CD16B	CFR-1716/IP SG White 17 x 16
3CD18J	CFR-1716/100 SG White 17 x 16
3CD18M	CFR-1716/138 SG White 17 x 16
3CD18P	CFR-1716/158 SG White 17 x 16
3CD18Q	CFR-1716/134 SG White 17 x 16
3CD18R	CFR-1716/178 SG White 17 x 16
3CD18S	CFR-1716/200 SG White 17 x 16
3CD26A	CFR-2016/P SG White 20 x 16
3CD26B	CFR-2016/IP SG White 20 x 16
3CD28J	CFR-2016/100 SG White 20 x 16
3CD28M	CFR-2016/138 SG White 20 x 16
3CD28P	CFR-2016/158 SG White 20 x 16
3CD28Q	CFR-2016/134 SG White 20 x 16
3CD28R	CFR-2016/178 SG White 20 x 16
3CD28S	CFR-2016/200 SG White 20 x 16
3CD46A	CFR-3516/P SG White 35 x 16
3CD46B	CFR-3516/IP SG White 35 x 16
3CD48J	CFR-3516/100 SG White 35 x 16
3CD48M	CFR-3516/138 SG White 35 x 16
3CD48P	CFR-3516/158 SG White 35 x 16
3CD48Q	CFR-3516/134 SG White 35 x 16
3CD48R	CFR-3516/178 SG White 35 x 16
3CD48S	CFR-3516/200 SG White 35 x 16

Stock	Description
3CD56A	CFR-3816/P SG White 38 x 16
3CD56B	CFR-3816/IP SG White 38 x 16
3CD58J	CFR-3816/100 SG White 38 x 16
3CD58M	CFR-3816/138 SG White 38 x 16
3CD58P	CFR-3816/158 SG White 38 x 16
3CD58Q	CFR-3816/134 SG White 38 x 16
3CD58R	CFR-3816/178 SG White 38 x 16
3CD58S	CFR-3816/200 SG White 38 x 16
3CD66A	CFR-4416/P SG White 44 x 16
3CD66B	CFR-4416/IP SG White 44 x 16
3CD68J	CFR-4416/100 SG White 44 x 16
3CD68M	CFR-4416/138 SG White 44 x 16
3CD68P	CFR-4416/158 SG White 44 x 16
3CD68Q	CFR-4416/134 SG White 44 x 16
3CD68R	CFR-4416/178 SG White 44 x 16
3CD68S	CFR-4416/200 SG White 44 x 16
3CD76A	CFR-5016/P SG White 50 x 16
3CD76B	CFR-5016/IP SG White 50 x 16
3CD78J	CFR-5016/100 SG White 50 x 16
3CD78M	CFR-5016/138 SG White 50 x 16
3CD78P	CFR-5016/158 SG White 50 x 16
3CD78Q	CFR-5016/134 SG White 50 x 16
3CD78R	CFR-5016/178 SG White 50 x 16
3CD78S	CFR-5016/200 SG White 50 x 16

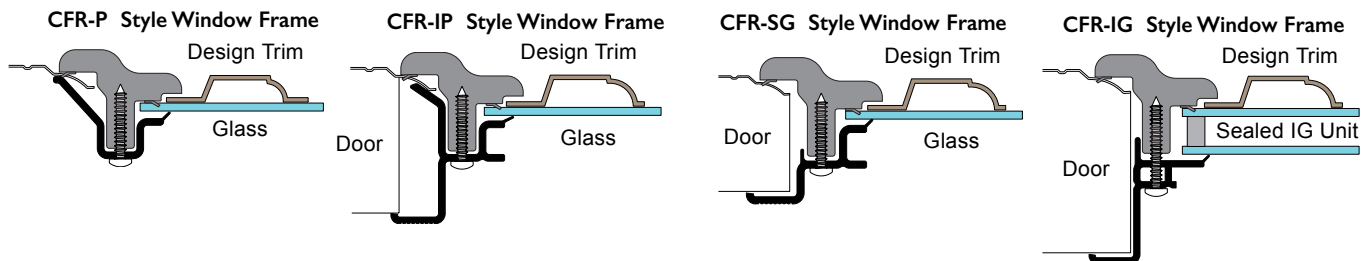

Above illustrations are only representative of actual designs. Actual designs may vary between sizes and manufacturers. The above designs are covered by one or more U.S. Patents. Other U.S. patent applications are pending

CMF Commercial Molded Frames

CMF Series Frames are available for both insulated and non-insulated doors and can accommodate both single and double pane glass.

- Easy screw together design
- Premium window frame system
- High performance injection molded frame
- Available in black polypropylene or white ASA material
- Available with or without glass
- While frame is paintable

Model	Outside Frame	Cut-out Size	Vision Area
246	24 3/8" x 6 1/8"	23 1/8" x 4 7/8"	20 59/64" x 2 11/16"
248	24 3/8" x 8 3/8"	23 1/8" x 7 1/8"	21 11/16" x 4 59/64"
2412	25 1/8" x 13 1/8"	23 7/8" x 11 7/8"	21 11/16" x 9 11/16"

Sizes Available

- All models available for 1", 1 3/8", 1 1/2", 1 5/8", 1 7/8", 2" thick doors

Colors

- White - Paintable ASA
- Black - Unpaintable Polypropylene

Glazing

- Double Strength (Standard)
- Tempered
- Acrylic (Plexiglass)
- Polycarbonate (Lexan)
- Other glass types available on a special order basis

Panel Fitting

Available for most manufacturers panels or can be customized to any design

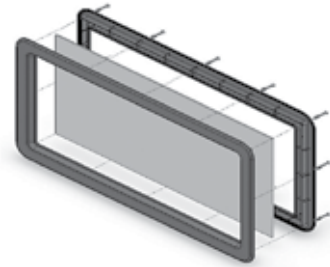
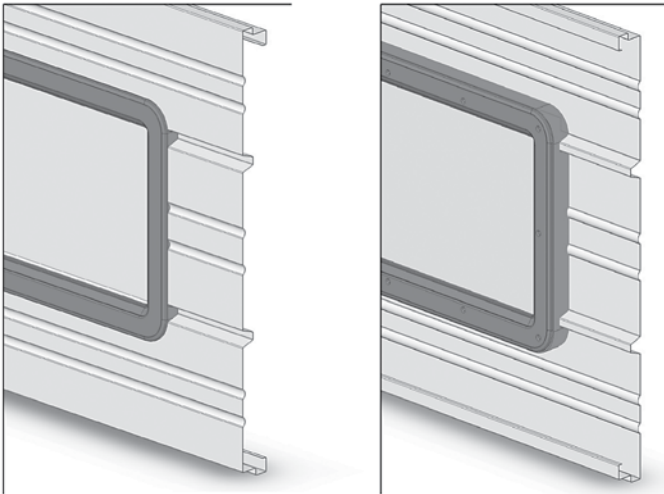

The following information is necessary for your customer service representative to determine the proper window frame and/or design trim best suited for your application:

- Glass size or cut out size
- Door thickness
- Ribbed door or flush door
- With or without glass
- Black or white frame

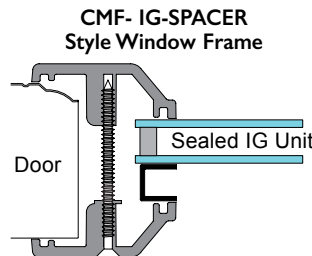
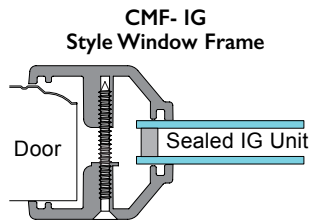
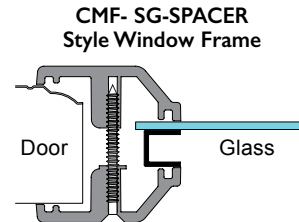
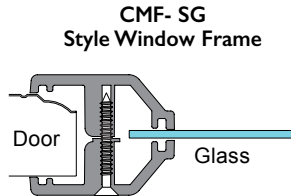
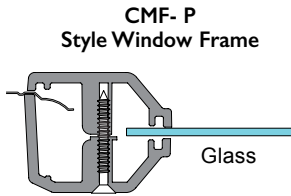

Above illustrations are only representative of actual designs. Actual designs may vary between sizes and manufacturers. The above designs are covered by one or more U.S. Patents. Other U.S. patent applications are pending

CWF Commercial Window Frames with Glass

Stock	Description
3XA3A0	CWF-244/P SG Commercial Window Frame - With Glass
3XA3Z0	CWF-244/IP SG Commercial Window Frame - With Glass
3XA3H0	CWF-244/138 SG Commercial Window Frame - With Glass
3XA3K0	CWF-244/163 SG Commercial Window Frame - With Glass
3XA3L0	CWF-244/175 SG Commercial Window Frame - With Glass
3XA3M0	CWF-244/188 SG Commercial Window Frame - With Glass
3XA3N0	CWF-244/200 SG Commercial Window Frame - With Glass
3XA4H0	CWF-244/138 IG Commercial Window Frame - With Glass
3XA4K0	CWF-244/163 IG Commercial Window Frame - With Glass
3XA4L0	CWF-244/175 IG Commercial Window Frame - With Glass
3XA4M0	CWF-244/188 IG Commercial Window Frame - With Glass
3XA4N0	CWF-244/200 IG Commercial Window Frame - With Glass
3XA4V0	CWF-244/288 IG Commercial Window Frame - With Glass
3XA3H1	CWF-245/138 SG Commercial Window Frame - With Glass
3XA3K1	CWF-245/163 SG Commercial Window Frame - With Glass
3XA3L1	CWF-245/175 SG Commercial Window Frame - With Glass
3XA3M1	CWF-245/188 SG Commercial Window Frame - With Glass
3XA3N1	CWF-245/200 SG Commercial Window Frame - With Glass
3XA4H1	CWF-245/138 IG Commercial Window Frame - With Glass
3XA4K1	CWF-245/163 IG Commercial Window Frame - With Glass
3XA4L1	CWF-245/175 IG Commercial Window Frame - With Glass
3XA4M1	CWF-245/188 IG Commercial Window Frame - With Glass
3XA4N1	CWF-245/200 IG Commercial Window Frame - With Glass
3XA4V1	CWF-245/288 IG Commercial Window Frame - With Glass
3XA3H2	CWF-247/138 SG Commercial Window Frame - With Glass
3XA3K2	CWF-247/163 SG Commercial Window Frame - With Glass
3XA3L2	CWF-247/175 SG Commercial Window Frame - With Glass
3XA3M2	CWF-247/188 SG Commercial Window Frame - With Glass
3XA3N2	CWF-247/200 SG Commercial Window Frame - With Glass
3XA4H2	CWF-247/138 IG Commercial Window Frame - With Glass
3XA4K2	CWF-247/163 IG Commercial Window Frame - With Glass
3XA4L2	CWF-247/175 IG Commercial Window Frame - With Glass
3XA4M2	CWF-247/188 IG Commercial Window Frame - With Glass
3XA4N2	CWF-247/200 IG Commercial Window Frame - With Glass
3XA4V2	CWF-247/288 IG Commercial Window Frame - With Glass
3XA3H4	CWF-2412/138 SG Commercial Window Frame - With Glass
3XA3K4	CWF-2412/163 SG Commercial Window Frame - With Glass
3XA3L4	CWF-2412/175 SG Commercial Window Frame - With Glass
3XA3M4	CWF-2412/188 SG Commercial Window Frame - With Glass
3XA3N4	CWF-2412/200 SG Commercial Window Frame - With Glass
3XA4H4	CWF-2412/138 IG Commercial Window Frame - With Glass
3XA4K4	CWF-2412/163 IG Commercial Window Frame - With Glass
3XA4L4	CWF-2412/175 IG Commercial Window Frame - With Glass
3XA4M4	CWF-2412/188 IG Commercial Window Frame - With Glass
3XA4N4	CWF-2412/200 IG Commercial Window Frame - With Glass
3XA4V4	CWF-2412/288 IG Commercial Window Frame - With Glass
3XA3H5	CWF-3012/138 SG Commercial Window Frame - With Glass
3XA3K5	CWF-3012/163 SG Commercial Window Frame - With Glass
3XA3L5	CWF-3012/175 SG Commercial Window Frame - With Glass
3XA3M5	CWF-3012/188 SG Commercial Window Frame - With Glass
3XA3N5	CWF-3012/200 SG Commercial Window Frame - With Glass
3XA4H5	CWF-3012/138 IG Commercial Window Frame - With Glass
3XA4K5	CWF-3012/163 IG Commercial Window Frame - With Glass
3XA4L5	CWF-3012/175 IG Commercial Window Frame - With Glass
3XA4M5	CWF-3012/188 IG Commercial Window Frame - With Glass
3XA4N5	CWF-3012/200 IG Commercial Window Frame - With Glass
3XA4V5	CWF-3012/288 IG Commercial Window Frame - With Glass

- Easy screw together design
- Available in various thicknesses
- All frames are supplied with or without glass
- Offered in white only

The CWF screw together frame is a standard window system, featuring screw assembly. The CWF includes two flexible vinyl seals on the exterior frame which eliminates the need for additional frame caulking.

CWF- P Style Window Frame

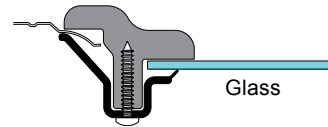

CWF- IP Style Window Frame

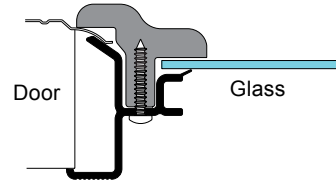

CWF- SG Style Window Frame

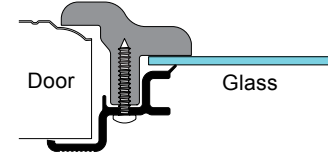

CWF- IG Style Window Frame

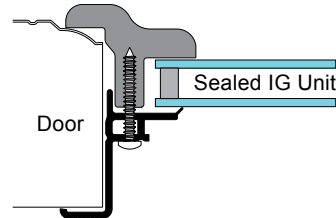

Above illustrations are only representative of actual designs. Actual designs may vary between sizes and manufacturers. The above designs are covered by one or more U.S. Patents. Other U.S. patent applications are pending

CWF Commercial Window Frames without Glass

Stock	Description
3XA8A0	CWF-244/P SG Commercial Window Frame - No Glass
3XA8Z0	CWF-244/IP SG Commercial Window Frame - No Glass
3XA6H0	CWF-244/138 SG Commercial Window Frame - No Glass
3XA6K0	CWF-244/163 SG Commercial Window Frame - No Glass
3XA6L0	CWF-244/175 SG Commercial Window Frame - No Glass
3XA6M0	CWF-244/188 SG Commercial Window Frame - No Glass
3XA6N0	CWF-244/200 SG Commercial Window Frame - No Glass
3XA7H0	CWF-244/138 IG Commercial Window Frame - No Glass
3XA7K0	CWF-244/163 IG Commercial Window Frame - No Glass
3XA7L0	CWF-244/175 IG Commercial Window Frame - No Glass
3XA7M0	CWF-244/188 IG Commercial Window Frame - No Glass
3XA7N0	CWF-244/200 IG Commercial Window Frame - No Glass
3XA7V0	CWF-244/288 IG Commercial Window Frame - No Glass
3XA6H1	CWF-245/138 SG Commercial Window Frame - No Glass
3XA6K1	CWF-245/163 SG Commercial Window Frame - No Glass
3XA6L1	CWF-245/175 SG Commercial Window Frame - No Glass
3XA6M1	CWF-245/188 SG Commercial Window Frame - No Glass
3XA6N1	CWF-245/200 SG Commercial Window Frame - No Glass
3XA7H1	CWF-245/138 IG Commercial Window Frame - No Glass
3XA7K1	CWF-245/163 IG Commercial Window Frame - No Glass
3XA7L1	CWF-245/175 IG Commercial Window Frame - No Glass
3XA7M1	CWF-245/188 IG Commercial Window Frame - No Glass
3XA7N1	CWF-245/200 IG Commercial Window Frame - No Glass
3XA7V1	CWF-245/288 IG Commercial Window Frame - No Glass
3XA6H2	CWF-247/138 SG Commercial Window Frame - No Glass
3XA6K2	CWF-247/163 SG Commercial Window Frame - No Glass
3XA6L2	CWF-247/175 SG Commercial Window Frame - No Glass
3XA6M2	CWF-247/188 SG Commercial Window Frame - No Glass
3XA6N2	CWF-247/200 SG Commercial Window Frame - No Glass
3XA7H2	CWF-247/138 IG Commercial Window Frame - No Glass
3XA7K2	CWF-247/163 IG Commercial Window Frame - No Glass
3XA7L2	CWF-247/175 IG Commercial Window Frame - No Glass
3XA7M2	CWF-247/188 IG Commercial Window Frame - No Glass
3XA7N2	CWF-247/200 IG Commercial Window Frame - No Glass
3XA7V2	CWF-247/288 IG Commercial Window Frame - No Glass
3XA6H4	CWF-2412/138 SG Commercial Window Frame - No Glass
3XA6K4	CWF-2412/163 SG Commercial Window Frame - No Glass
3XA6L4	CWF-2412/175 SG Commercial Window Frame - No Glass
3XA6M4	CWF-2412/188 SG Commercial Window Frame - No Glass
3XA6N4	CWF-2412/200 SG Commercial Window Frame - No Glass
3XA7H4	CWF-2412/138 IG Commercial Window Frame - No Glass
3XA7K4	CWF-2412/163 IG Commercial Window Frame - No Glass
3XA7L4	CWF-2412/175 IG Commercial Window Frame - No Glass
3XA7M4	CWF-2412/188 IG Commercial Window Frame - No Glass
3XA7N4	CWF-2412/200 IG Commercial Window Frame - No Glass
3XA7V4	CWF-2412/288 IG Commercial Window Frame - No Glass
3XA6H5	CWF-3012/138 SG Commercial Window Frame - No Glass
3XA6K5	CWF-3012/163 SG Commercial Window Frame - No Glass
3XA6L5	CWF-3012/175 SG Commercial Window Frame - No Glass
3XA6M5	CWF-3012/188 SG Commercial Window Frame - No Glass
3XA6N5	CWF-3012/200 SG Commercial Window Frame - No Glass
3XA7H5	CWF-3012/138 IG Commercial Window Frame - No Glass
3XA7K5	CWF-3012/163 IG Commercial Window Frame - No Glass
3XA7L5	CWF-3012/175 IG Commercial Window Frame - No Glass
3XA7M5	CWF-3012/188 IG Commercial Window Frame - No Glass
3XA7N5	CWF-3012/200 IG Commercial Window Frame - No Glass
3XA7V5	CWF-3012/288 IG Commercial Window Frame - No Glass

- Easy screw together design
- Available in various thicknesses
- All frames are supplied with or without glass
- Offered in white only

The CWF screw together frame is a standard window system, featuring screw assembly. The CWF includes two flexible vinyl seals on the exterior frame which eliminates the need for additional frame caulking.

CWF- P Style Window Frame

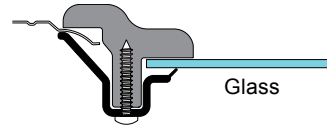

CWF- IP Style Window Frame

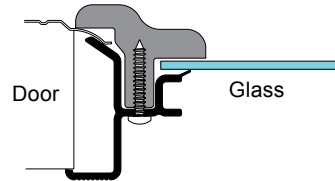

CWF- SG Style Window Frame

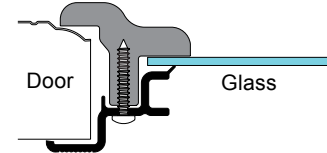

CWF- IG Style Window Frame

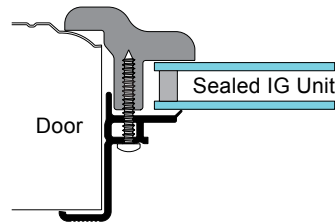

Above illustrations are only representative of actual designs. Actual designs may vary between sizes and manufacturers. The above designs are covered by one or more U.S. Patents. Other U.S. patent applications are pending

National Bulk Glass

National Door is one of the largest glass suppliers serving the Garage Door Industry – OEM, Distributors & Dealers

- High quality clear float glass, SSB, DSB, Tempered, Satin, Insulated, Satin Etched, or Colored
- Any size is available, call us for price and availability
- Large, Small, and mini crate quantities available
- Domestic supplier
- Direct shipments from our factory
- FTL, LTL and Customer pick up
- Excellent lead times
- Wood Crate Packaging: **Large, Small & Mini crates**

Standard Products:

- 2.5mm Clear Glass
- 3.0mm Clear Glass
- 3.0mm Obscure/ P62
- 3.0mm Gray/Tint
- 3.0mm Satin Etched
- Insulated Glass Units (Tempering Available)



Clear



Obscure/ P62



Gray/Tint



Satin Etch

Garage Door Vent Kits With Frame

- Clean professional appearance
- Fast simple installation
- Kit includes frame and fully screened white aluminum vent
- Ideal for vault garages and building code compliance

Stock	Description
307510	11" x 6" Vent Frame Kit for Pan Doors
307520	11" x 6" Vent Frame Kit for 1 3/8" Doors
307530	11" x 6" Vent Frame Kit for 2" Doors
307550	16" x 6" Vent Frame Kit for Pan Doors
307560	16" x 6" Vent Frame Kit for 1 3/8" Doors
307570	16" x 6" Vent Frame Kit for 2" Doors



VFK-116 Snap Together Vent Kit for uninsulated pan doors



VFK-116R Screw Together Vent Kit for insulated doors



VFK-166 Snap Together Vent Kit for uninsulated pan doors

Above illustrations are only representative of actual designs. Actual designs may vary between sizes and manufacturers. The above designs are covered by one or more U.S. Patents. Other U.S. patent applications are pending

National Door proudly supports international OEMs



Above illustrations are only representative of actual designs. Actual designs may vary between sizes and manufacturers. The above designs are covered by one or more U.S. Patents. Other U.S. patent applications are pending.

DESIGN TRIM

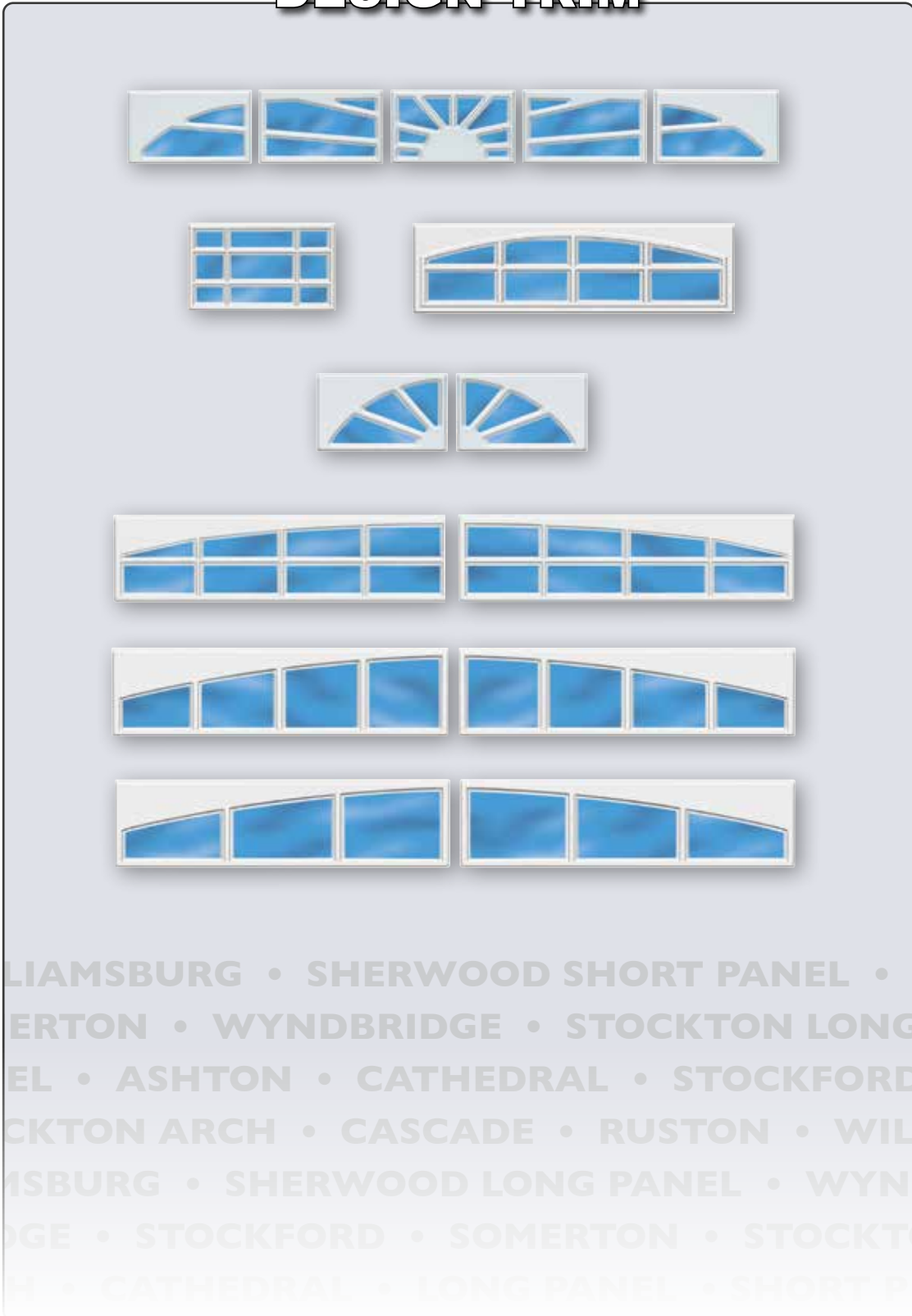

DESIGN TRIM

Proudly Supporting



Call Customer Service for more information

Amarr Design Trim

Application Notes:

- Use the -IAM design trim for short panel window frames
- Use the -3AM design trim for long panel window frames
- All design trim is supplied unpainted, ask customer service about custom painted parts
- To maintain color stability, Stylecraft™ Design Trim should be painted.

Stock	Description
Cathedral	
8AM11399	393-1AM Cathedral Stylecraft™ Design Trim
8AM13399	393-3AM Cathedral Stylecraft™ Design Trim
Stockton	
8AM113D9	397-1AM Stockton Stylecraft™ Design Trim
8AM133D9	397-3AM Stockton Stylecraft™ Design Trim - 12 Lite
Williamsburg	
8AM11319	305-1AM Williamsburg Stylecraft™ Design Trim - 4 pc set
8AM13319	305-3AM Williamsburg Stylecraft™ Design Trim - 2 pc set
8AM113F9	405-1AM Williamsburg Stylecraft™ Design Trim - 8 pc set
8AM133F9	405-3AM Williamsburg Stylecraft™ Design Trim - 4 pc set
Sherwood	
8AM11329	306-1AM Sherwood Stylecraft™ Design Trim - 2 pc set
8AM13329	306-3AM Sherwood Stylecraft™ Design Trim
Cascade	
8AM11409	591-1AM Cascade Stylecraft™ Design Trim
8AM13409	591-3AM Cascade Stylecraft™ Design Trim
Waterton	
8AM11339	320-1AM Waterton Stylecraft™ Design Trim
8AM13339	320-3AM Waterton Stylecraft™ Design Trim
Stockford	
8AM13499	697-3AM Stockford Stylecraft™ Design Trim
Prairie	
8AM114D9	897-1AM Prairie Stylecraft™ Design Trim
Somerton	
8AM134K9	489-3AM Somerton Stylecraft™ Design Trim - 12 Lite
Wyndbridge	
8AM133J9	588-3AM Wyndbridge Stylecraft™ Design Trim
Stockbridge	
8AM133G9	587-3AM Stockbridge Stylecraft™ Design Trim



405 Williamsburg



405-3 Williamsburg



305 Williamsburg



305-3 Williamsburg



393-3 Cathedral



393 Cathedral



397-3 Stockton



397 Stockton



591-3 Cascade



591 Cascade



320-3 Waterton



320 Waterton



697-3 Stockford



897 Prairie



306-3 Sherwood



306 Sherwood



489-3 Somerton



588-3 Wyndbridge



587-3 Stockbridge

Above illustrations are only representative of actual designs. Actual designs may vary between sizes and manufacturers. The above designs are covered by one or more U.S. Patents. Other U.S. patent applications are pending

CHI Design Trim

Application Notes:

- Use the -1CH design trim for short panel window frames
- Use the -3CH design trim for long panel window frames
- All design trim is supplied unpainted, ask customer service about custom painted parts
- To maintain color stability, Stylecraft™ and Styleline™ Design Trim should be painted.

Stock	Description
Ruston	
8CH0A9	390-1CH Ruston Stylecraft™ Design Trim
Madison	
8CH0B9	391-1CH Madison Stylecraft™ Design Trim
Winston	
8CH0C9	392-1CH Winston Stylecraft™ Design Trim - 2 pc set
Cathedral	
8CH0D9	393-1CH Cathedral Stylecraft™ Design Trim
8CH2D9	393-3CH Cathedral Stylecraft™ Design Trim
Stockton	
8CH0H9	397-1CH Stockton Stylecraft™ Design Trim - 4 Lite
8CH2H9	397-3CH Stockton Stylecraft™ Design Trim - 10 Lite
8CH279	799-3CH Stockton Stylecraft™ Design Trim - 6 Lite
Williamsburg	
8CH0J9	305-1CH Williamsburg Stylecraft™ Design Trim - 4 pc set
8CH2J9	305-3CH Williamsburg Stylecraft™ Design Trim - 2 pc set
Sherwood	
8CH0K9	306-1CH Sherwood Stylecraft™ Design Trim - 2 pc set
8CH2K9	306-3CH Sherwood Stylecraft™ Design Trim
Williamsburg	
8CH0L9	405-1CH Williamsburg Stylecraft™ Design Trim - 8 pc set
8CH5L9	405-15CH Williamsburg Stylecraft™ Design Trim - 7 pc set
8CH9L9	405-10CH Williamsburg Stylecraft™ Design Trim - 5 pc set
8CH2L9	405-3CH Williamsburg Stylecraft™ Design Trim - 4 pc set
Cascade	
8CH0M9	591-1CH Cascade Stylecraft™ Design Trim
8CH2M9	591-3CH Cascade Stylecraft™ Design Trim
Stockbridge	
8CH0N9	597-1CH Stockbridge Stylecraft™ Design Trim - 3 Lite
8CH2N9	597-3CH Stockbridge Stylecraft™ Design Trim - 4 Lite
8CH2Q9	587-3CH Stockbridge Stylecraft™ Design Trim - 3 Lite
Waterton	
8CH0P9	320-1CH Waterton Stylecraft™ Design Trim
8CH2P9	320-3CH Waterton Stylecraft™ Design Trim
Ashton	
8CH0R9	604-1CH Ashton Stylecraft™ Design Trim
8CH2R9	604-3CH Ashton Stylecraft™ Design Trim
Stockford	
8CH0Z9	697-1CH Stockford Stylecraft™ Design Trim
8CH2Z9	697-3CH Stockford Stylecraft™ Design Trim
Wyndbridge	
8CH2T9	588-3CH Wyndbridge Stylecraft™ Design Trim
Somerton	
8CH2U9	388-3CH Somerton Stylecraft™ Design Trim
Prairie	
9CHSL234D9	897-3CHSL Prairie Styleline™ Design Trim



405 Williamsburg



405-3 Williamsburg



405-15 Williamsburg



405-10 Williamsburg



305 Williamsburg



305-3 Williamsburg



597-3 Stockbridge



597 Stockbridge



697-3 Stockford



587-3 Stockbridge



390 Ruston



697 Stockford



393-3 Cathedral



393 Cathedral



306-3 Sherwood



897-3 Prairie



391 Madison



306 Sherwood



591-3 Cascade



591 Cascade



392 Winston



604-3 Ashton



604 Ashton



397-3 Stockton



320-3 Waterton



320 Waterton



799-3 Stockton



388-3 Somerton



397 Stockton



588-3 Wyndbridge

Above illustrations are only representative of actual designs. Actual designs may vary between sizes and manufacturers. The above designs are covered by one or more U.S. Patents. Other U.S. patent applications are pending.

Clopay Design Trim

Application Notes:

- Use the -1CL design trim for short panel window frames
- Use the -3CL design trim for long panel window frames
- All design trim is supplied unpainted, ask customer service about custom painted parts
- To maintain color stability, Stylecraft™ Design Trim should be painted.

Stock	Description
Ruston	
8CL0A9	390-1CL Ruston Stylecraft™ Design Trim
8CL2A9	390-3CL Ruston Stylecraft™ Design Trim
Cathedral	
8CL0D9	393-1CL Cathedral Stylecraft™ Design Trim
8CL2D9	393-3CL Cathedral Stylecraft™ Design Trim
Stockton	
8CL0H9	397-1CL Stockton Stylecraft™ Design Trim
8CL2H9	397-3CL Stockton Stylecraft™ Design Trim - 10 Lite
Williamsburg	
8CL0J9	305-1CL Williamsburg Stylecraft™ Design Trim - 4 pc set
8CL2J9	305-3CL Williamsburg Stylecraft™ Design Trim - 2 pc set
Sherwood	
8CL0K9	306-1CL Sherwood Stylecraft™ Design Trim - 2 pc set
8CL2K9	306-3CL Sherwood Stylecraft™ Design Trim - 2 pc set
Williamsburg	
8CL0L9	405-1CL Williamsburg Stylecraft™ Design Trim - 8 pc set
8CL5L9	405-15CL Williamsburg Stylecraft™ Design Trim - 7 pc set
8CL9L9	405-10CL Williamsburg Stylecraft™ Design Trim - 5 pc set
8CL2L9	405-3CL Williamsburg Stylecraft™ Design Trim - 4 pc set
Cascade	
8CL0M9	591-1CL Cascade Stylecraft™ Design Trim
8CL2M9	591-3CL Cascade Stylecraft™ Design Trim
Waterton	
8CL0P9	320-1CL Waterton Stylecraft™ Design Trim
8CL2P9	320-3CL Waterton Stylecraft™ Design Trim
Ashton	
8CL0R9	604-1CL Ashton Stylecraft™ Design Trim



405 Williamsburg



405-3 Williamsburg



405-15 Williamsburg



405-10 Williamsburg



305 Williamsburg



305-3 Williamsburg



393-3 Cathedral



393 Cathedral



397-3 Stockton



397 Stockton



390-3 Ruston



390 Ruston



591-3 Cascade



591 Cascade



320-3 Waterton



320 Waterton



306 Sherwood



604 Ashton

Above illustrations are only representative of actual designs. Actual designs may vary between sizes and manufacturers. The above designs are covered by one or more U.S. Patents. Other U.S. patent applications are pending

Belden Design Trim

Application Notes:

- Use the -1AM design trim for short panel window frames
- Use the -3AM design trim for long panel window frames
- All design trim is supplied unpainted, ask customer service about custom painted parts
- To maintain color stability, Stylecraft™ Design Trim should be painted.

Stock	Description
Cathedral	
8AM11399	393-1AM Cathedral Stylecraft™ Design Trim
8AM13399	393-3AM Cathedral Stylecraft™ Design Trim
Stockton	
8AM113D9	397-1AM Stockton Stylecraft™ Design Trim
8AM133D9	397-3AM Stockton Stylecraft™ Design Trim - 12 Lite
Williamsburg	
8AM11319	305-1AM Williamsburg Stylecraft™ Design Trim - 4 pc set
8AM13319	305-3AM Williamsburg Stylecraft™ Design Trim - 2 pc set
8AM113F9	405-1AM Williamsburg Stylecraft™ Design Trim - 8 pc set
8AM133F9	405-3AM Williamsburg Stylecraft™ Design Trim - 4 pc set
Sherwood	
8AM11329	306-1AM Sherwood Stylecraft™ Design Trim - 2 pc set
8AM13329	306-3AM Sherwood Stylecraft™ Design Trim
Cascade	
8AM11409	591-1AM Cascade Stylecraft™ Design Trim
8AM13409	591-3AM Cascade Stylecraft™ Design Trim
Waterton	
8AM11339	320-1AM Waterton Stylecraft™ Design Trim
8AM13339	320-3AM Waterton Stylecraft™ Design Trim
Stockford	
8AM13499	697-3AM Stockford Stylecraft™ Design Trim
Prairie	
8AM114D9	897-1AM Prairie Stylecraft™ Design Trim
Somerton	
8AM134K9	489-3AM Somerton Stylecraft™ Design Trim - 12 Lite
Wyndbridge	
8AM133J9	588-3AM Wyndbridge Stylecraft™ Design Trim
Stockbridge	
8AM133G9	587-3AM Stockbridge Stylecraft™ Design Trim



405 Williamsburg



405-3 Williamsburg



305 Williamsburg



305-3 Williamsburg



393-3 Cathedral



393 Cathedral



397-3 Stockton



397 Stockton



591-3 Cascade



591 Cascade



320-3 Waterton



320 Waterton



697-3 Stockford



897 Prairie



306-3 Sherwood



306 Sherwood



489-3 Somerton



588-3 Wyndbridge



587-3 Stockbridge

Above illustrations are only representative of actual designs. Actual designs may vary between sizes and manufacturers. The above designs are covered by one or more U.S. Patents. Other U.S. patent applications are pending.

Direct Dial: (817) 834-7300

DoorLink Design Trim

Application Notes:

- Use the -IDL design trim for short panel window frames
- Use the -3DL design trim for ranch panel window frames
- Use the -4216DL design trim for carriage house window frames
- Use the -4416DL design trim for long panel window frames
- All design trim is supplied unpainted, ask customer service about custom painted parts
- To maintain color stability, Stylecraft™ and Styleline™ Design Trim should be painted.

Stock	Description
Ruston	
8DL0A9	390-1DL Ruston Stylecraft™ Design Trim
8DL2A9	390-3DL Ruston Stylecraft™ Design Trim
Cathedral	
8DL0D9	393-1DL Cathedral Stylecraft™ Design Trim
8DL2D9	393-3DL Cathedral Stylecraft™ Design Trim
Stockton	
9DL213D9	397-1DLSL Stockton Styleline™ Design Trim
9DL2B3D9	397-3DLSL Stockton Styleline™ Design Trim - 12 Lite
Williamsburg	
8DL0J9	305-1DL Williamsburg Stylecraft™ Design Trim - 4 pc set
8DL2J9	305-3DL Williamsburg Stylecraft™ Design Trim - 2 pc set
Sherwood	
8DL0K9	306-1DL Sherwood Stylecraft™ Design Trim - 2 pc set
8DL2K9	306-3DL Sherwood Stylecraft™ Design Trim
Williamsburg	
8DL0L9	405-1DL Williamsburg Stylecraft™ Design Trim - 8 pc set
8DL2L9	405-3DL Williamsburg Stylecraft™ Design Trim - 4 pc set
8DL5L9	405-15DL Williamsburg Stylecraft™ Design Trim - 7 pc set
8DL9L9	405-10DL Williamsburg Stylecraft™ Design Trim - 5 pc set
Cascade	
9DL21409	591-1DLSL Cascade Styleline™ Design Trim
9DL2B409	591-3DLSL Cascade Styleline™ Design Trim
Stockbridge	
9DL21429	597-1DLSL Stockbridge Styleline™ Design Trim
9DL2B429	597-3DLSL Stockbridge Styleline™ Design Trim
Waterton	
9DL21339	320-1DLSL Waterton Styleline™ Design Trim
8DL2P9	320-3DLS Waterton Stylecraft™ Design Trim
Ashton	
8DL0R9	604-1DL Ashton Stylecraft™ Design Trim
8DL2R9	604-3DL Ashton Stylecraft™ Design Trim
Stockford	
8DL0Z9	697-1DL Stockford Stylecraft™ Design Trim
8DL0Z9	697-1DL Stockford Stylecraft™ Design Trim
Prairie	
9DL214D9	897-1DLSL Prairie Styleline™ Design Trim
8DL229	897-3DL Prairie Stylecraft™ Design Trim
8CD9W9	897-4216DLSL Prairie Stylecraft™ Design Trim
8CD9Y9	897-4416DLSL Prairie Stylecraft™ Design Trim
Stockton Arch	
9CDSL0Y9	287-4216DLSL Stockton Arch Styleline™ Design Trim
9CDSL0W9	287-4416DLSL Stockton Arch Styleline™ Design Trim
Stockton	
9CDSL1Y9	387-4216DLSL Stockton Styleline™ Design Trim
9CDSL1W9	387-4416DLSL Stockton Styleline™ Design Trim
Somerton	
9CDSL2Y9	388-4216DLSL Somerton Styleline™ Design Trim
9CDSL2W9	388-4416DLSL Somerton Styleline™ Design Trim
Stockbridge	
9CDSL3Y9	587-4216DLSL Stockbridge Styleline™ Design Trim
9CDSL3W9	587-4416DLSL Stockbridge Styleline™ Design Trim
Wyndbridge	
9CDSL4Y9	588-4216DLSL Wyndbridge Styleline™ Design Trim
9CDSL4W9	588-4416DLSL Wyndbridge Styleline™ Design Trim



405 Williamsburg



405-3 Williamsburg



405-15 Williamsburg



405-10 Williamsburg



305 Williamsburg



305-3 Williamsburg



591-3 Cascade



591 Cascade



604-3 Ashton



604 Ashton



597-3 Stockbridge



597 Stockbridge



320-3 Waterton



320 Waterton



393-3 Cathedral



393 Cathedral



390-3 Ruston



390 Ruston



397-3 Stockton



397 Stockton



697-3 Stockford



697 Stockford



897-3 Prairie



897 Prairie



306-3 Sherwood



306 Sherwood



588-4216 / 4416 Wyndbridge



388-4216 / 4416 Somerton



387-4216 / 4416 Stockton



287-4216 / 4416 Stockton



587-4216 / 4416 Stockbridge

Above illustrations are only representative of actual designs. Actual designs may vary between sizes and manufacturers. The above designs are covered by one or more U.S. Patents. Other U.S. patent applications are pending

Email: sales@natdoor.com



First United Door Technologies Design Trim

Application Notes:

- Use the -1UD design trim for short panel window frames
- Use the -3UD design trim for long panel window frames
- All design trim is supplied unpainted, ask customer service about custom painted parts
- To maintain color stability, Stylecraft™ Design Trim should be painted.

Stock	Description
Ruston	
8UD0A9	390-1UD Ruston Stylecraft™ Design Trim
Cathedral	
8UD0D9	393-1UD Cathedral Stylecraft™ Design Trim
8UD2D9	393-3UD Cathedral Stylecraft™ Design Trim
Stockton	
8UD0H9	397-1UD Stockton Stylecraft™ Design Trim
8UD2H9	397-3UD Stockton Stylecraft™ Design Trim
Williamsburg	
8UD0J9	305-1UD Williamsburg Stylecraft™ Design Trim - 4 pc set
8UD2J9	305-3UD Williamsburg Stylecraft™ Design Trim - 2 pc set
Sherwood	
8UD0K9	306-1UD Sherwood Stylecraft™ Design Trim - 2 pc set
8UD2K9	306-3UD Sherwood Stylecraft™ Design Trim
Williamsburg	
8UD0L9	405-1UD Williamsburg Stylecraft™ Design Trim - 8 pc set
8UD5L9	405-15UD Williamsburg Stylecraft™ Design Trim - 7 pc set
8UD9L9	405-10UD Williamsburg Stylecraft™ Design Trim - 5 pc set
8UD2L9	405-3UD Williamsburg Stylecraft™ Design Trim - 4 pc set
Cascade	
8UD0M9	591-1UD Cascade Stylecraft™ Design Trim
8UD2M9	591-3UD Cascade Stylecraft™ Design Trim
Stockbridge	
8UD2N9	597-3UD Stockbridge Stylecraft™ Design Trim
Waterton	
8UD0P9	320-1UD Waterton Stylecraft™ Design Trim
8UD2P9	320-3UD Waterton Stylecraft™ Design Trim
Ashton	
8UD0R9	604-1UD Ashton Stylecraft™ Design Trim
Stockford	
8UD0Z9	697-1UD Stockford Stylecraft™ Design Trim



405 Williamsburg



405-3 Williamsburg



405-15 Williamsburg



405-10 Williamsburg



305 Williamsburg



305-3 Williamsburg



306-3 Sherwood



306 Sherwood



393-3 Cathedral



393 Cathedral



397-3 Stockton



397 Stockton



591-3 Cascade



591 Cascade



320-3 Waterton



320 Waterton



597-3 Stockbridge



390 Ruston



697 Stockford



604 Ashton

Above illustrations are only representative of actual designs. Actual designs may vary between sizes and manufacturers. The above designs are covered by one or more U.S. Patents. Other U.S. patent applications are pending.

General Door Design Trim

Application Notes:

- Use the -1GES design trim for 8' x 16' doors
- Use the -2GES design trim for 9' x 18' doors
- Use the -3GES design trim for 8' x 16' doors
- Use the -12GES design trim for 9' x 18' doors
- All design trim is supplied unpainted, ask customer service about custom painted parts
- To maintain color stability, Stylecraft™ and Styleline™ Design Trim should be painted.

Stock	Description
Ruston	
8GE0A9	390-1GES Ruston Stylecraft™ Design Trim
8GE1A9	390-2GES Ruston Stylecraft™ Design Trim
8GE2A9	390-3GES Ruston Stylecraft™ Design Trim
Madison	
8GE0B9	391-1GES Madison Stylecraft™ Design Trim
Winston	
8GE0C9	392-1GES Winston Stylecraft™ Design Trim - 2 pc set
Cathedral	
8GE0D9	393-1GES Cathedral Stylecraft™ Design Trim
8GE1D9	393-2GES Cathedral Stylecraft™ Design Trim
8GE2D9	393-3GES Cathedral Stylecraft™ Design Trim
Stockton	
8GE0H9	397-1GES Stockton Stylecraft™ Design Trim
8GE1H9	397-2GES Stockton Stylecraft™ Design Trim
8GE219	387-3GES Stockton Stylecraft™ Design Trim - 8 Lite
8GE2H9	397-3GES Stockton Stylecraft™ Design Trim - 12 Lite
8GE4H9	397-12GES Stockton Stylecraft™ Design Trim - 12 Lite
8GE1B4B9	798-3GES Stockton Stylecraft™ Design Trim - 10 Lite
Williamsburg	
8GE0J9	305-1GES Williamsburg Stylecraft™ Design Trim - 4 pc set
8GE1J9	305-2GES Williamsburg Stylecraft™ Design Trim - 4 pc set
8GE2J9	305-3GES Williamsburg Stylecraft™ Design Trim - 2 pc set
8GE4J9	305-12GES Williamsburg Stylecraft™ Design Trim - 2 pc set
Sherwood	
8GE0K9	306-1GES Sherwood Stylecraft™ Design Trim - 2 pc set
8GE1K9	306-2GES Sherwood Stylecraft™ Design Trim - 2 pc set
8GE2K9	306-3GES Sherwood Stylecraft™ Design Trim
8GE4K9	306-12GES Sherwood Stylecraft™ Design Trim
Williamsburg	
8GE0L9	405-1GES Williamsburg Stylecraft™ Design Trim - 8 pc set
8GE1L9	405-2GES Williamsburg Stylecraft™ Design Trim - 8 pc set
8GE2L9	405-3GES Williamsburg Stylecraft™ Design Trim - 4 pc set
8GE9L9	405-10GES Williamsburg Stylecraft™ Design Trim - 5 pc set
8GE4L9	405-12GES Williamsburg Stylecraft™ Design Trim - 4 pc set
8GE5L9	405-15GES Williamsburg Stylecraft™ Design Trim - 7 pc set
Cascade	
8GE0M9	591-1GES Cascade Stylecraft™ Design Trim
8GE1M9	591-2GES Cascade Stylecraft™ Design Trim
8GE2M9	591-3GES Cascade Stylecraft™ Design Trim
8GE4M9	591-12GES Cascade Stylecraft™ Design Trim
Waterton	
8GE0P9	320-1GES Waterton Stylecraft™ Design Trim
8GE1P9	320-2GES Waterton Stylecraft™ Design Trim
8GE2P9	320-3GES Waterton Stylecraft™ Design Trim
8GE4P9	320-12GES Waterton Stylecraft™ Design Trim
Ashton	
8GE0R9	604-1GES Ashton Stylecraft™ Design Trim
8GE1R9	604-2GES Ashton Stylecraft™ Design Trim
8GE2R9	604-3GES Ashton Stylecraft™ Design Trim
Stockford	
8GE0Z9	697-1GES Stockford Stylecraft™ Design Trim
8GE1Z9	697-2GES Stockford Stylecraft™ Design Trim
8GE2Z9	697-3GES Stockford Stylecraft™ Design Trim
Somerton	
8GE2U9	388-3GES Somerton Stylecraft™ Design Trim
8GE4U9	388-12GES Somerton Stylecraft™ Design Trim
Wyndbridge	
8GE2T9	588-3GES Wyndbridge Stylecraft™ Design Trim
8GE4T9	588-12GES Wyndbridge Stylecraft™ Design Trim
Stockbridge	
8GE2Q9	587-3GES Stockbridge Stylecraft™ Design Trim - 4 Lite
8GE2N9	597-3GES Stockbridge Stylecraft™ Design Trim - 3 Lite



405 Williamsburg



405-3 Williamsburg



405-15 Williamsburg



405-10 Williamsburg



305 Williamsburg



305-3 Williamsburg



697-3 Stockford 697 Stockford 320-3 Waterton 320 Waterton



393-3 Cathedral 393 Cathedral 604-3 Ashton 604 Ashton



591-3 Cascade 591 Cascade 390-3 Ruston 390 Ruston



387-3 Stockton 397 Stockton 798-3 Stockton



397-3 Stockton 391 Madison 597-3 Stockbridge



388-3 Somerton 588-3 Wyndbridge



587-3 Stockbridge 392 Winston



306 Sherwood 306-3 Sherwood

Above illustrations are only representative of actual designs. Actual designs may vary between sizes and manufacturers. The above designs are covered by one or more U.S. Patents. Other U.S. patent applications are pending

Haas Design Trim

Application Notes:

- Use the -IHAS design trim for short panel window frames
- Use the -IHAP design trim for short panel window frames
- Use the -3HAS design trim for long panel window frames
- All design trim is supplied unpainted, ask customer service about custom painted parts
- To maintain color stability, Stylecraft™ Design Trim should be painted.

Stock	Description
Ruston	
8HA0A9	390-1HAS Ruston Stylecraft™ Design Trim
7HA0A9	390-1HAP Ruston Stylecraft™ Design Trim
8HA2A9	390-3HAS Ruston Stylecraft™ Design Trim
Cathedral	
8HA0D9	393-1HAS Cathedral Stylecraft™ Design Trim
7HA0D9	393-1HAP Cathedral Stylecraft™ Design Trim
8HA2D9	393-3HAS Cathedral Stylecraft™ Design Trim
Stockton	
8HA0H9	397-1HAS Stockton Stylecraft™ Design Trim - 4 Lite
7HA0H9	397-1HAP Stockton Stylecraft™ Design Trim - 4 Lite
8HA2H9	397-3HAS Stockton Stylecraft™ Design Trim - 10 Lite
Williamsburg	
8HA0J9	305-1HAS Williamsburg Stylecraft™ Design Trim - 4 pc set
7HA0J9	305-1HAP Williamsburg Stylecraft™ Design Trim - 4 pc set
8HA2J9	305-3HAS Williamsburg Stylecraft™ Design Trim - 2 pc set
Sherwood	
8HA0K9	306-1HAS Sherwood Stylecraft™ Design Trim - 2 pc set
7HA0K9	306-1HAP Sherwood Stylecraft™ Design Trim - 2 pc set
Williamsburg	
8HA0L9	405-1HAS Williamsburg Stylecraft™ Design Trim - 8 pc set
7HA0L9	405-1HAP Williamsburg Stylecraft™ Design Trim - 8 pc set
8HA5L9	405-15HAS Williamsburg Stylecraft™ Design Trim - 7 pc set
7HA5L9	405-15HAP Williamsburg Stylecraft™ Design Trim - 7 pc set
8HA9L9	405-10HAS Williamsburg Stylecraft™ Design Trim - 5 pc set
8HA2L9	405-3HAS Williamsburg Stylecraft™ Design Trim - 4 pc set
7HA9L9	405-10HAP Williamsburg Stylecraft™ Design Trim - 5 pc set
Cascade	
8HA0M9	591-1HAS Cascade Stylecraft™ Design Trim
7HA0M9	591-1HAP Cascade Stylecraft™ Design Trim
8HA2M9	591-3HAS Cascade Stylecraft™ Design Trim
Stockbridge	
8HA0N9	597-1HAS Stockbridge Stylecraft™ Design Trim
8HA2N9	597-3HAS Stockbridge Stylecraft™ Design Trim
Waterton	
8HA0P9	320-1HAS Waterton Stylecraft™ Design Trim
7HA0P9	320-1HAP Waterton Stylecraft™ Design Trim
8HA2P9	320-3HAS Waterton Stylecraft™ Design Trim
Ashton	
8HA0R9	604-1HAS Ashton Stylecraft™ Design Trim
7HA0R9	604-1HAP Ashton Stylecraft™ Design Trim
8HA2R9	604-3HAS Ashton Stylecraft™ Design Trim
Stockford	
8HA0Z9	697-1HAS Stockford Stylecraft™ Design Trim
7HA0Z9	697-1HAP Stockford Stylecraft™ Design Trim
8HA2Z9	697-3HAS Stockford Stylecraft™ Design Trim
Prairie	
8HA019	897-1HAS Prairie Stylecraft™ Design Trim
8HA219	897-3HAS Prairie Stylecraft™ Design Trim

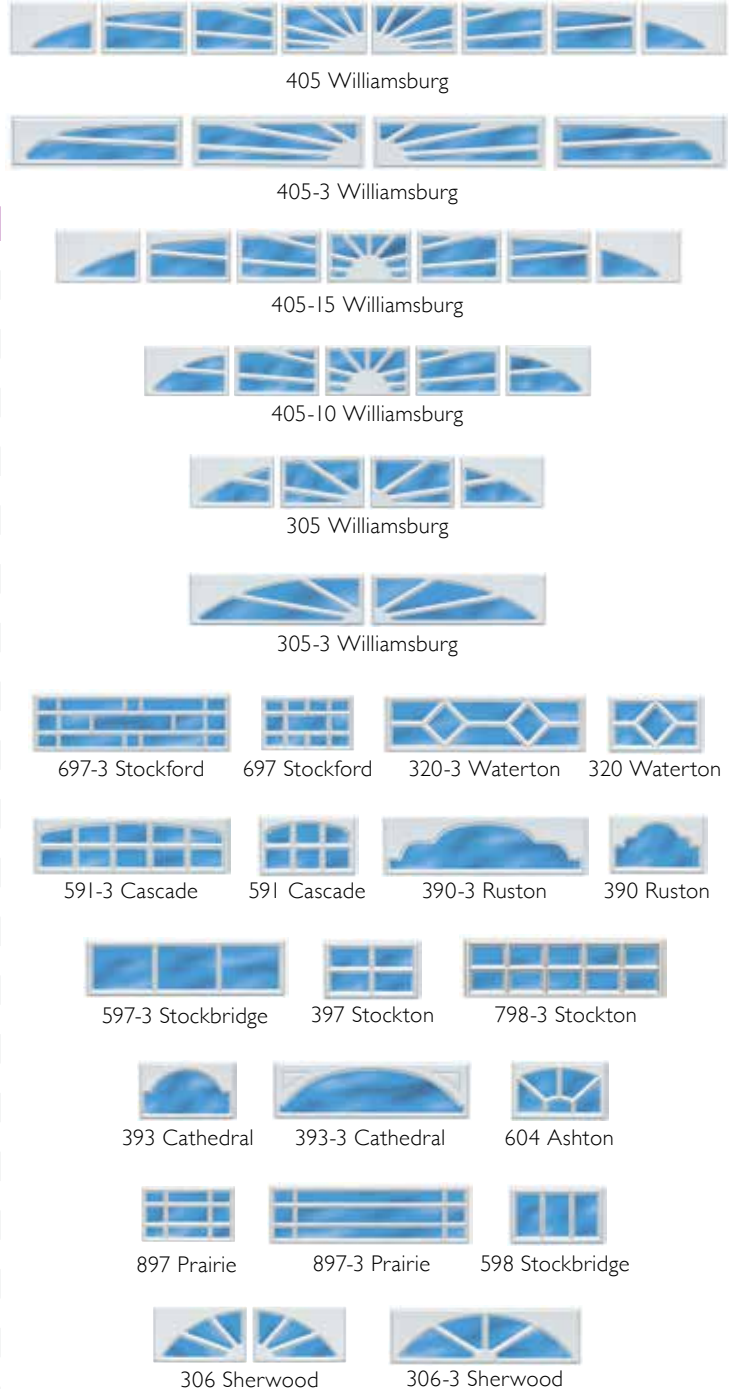

Above illustrations are only representative of actual designs. Actual designs may vary between sizes and manufacturers. The above designs are covered by one or more U.S. Patents. Other U.S. patent applications are pending

Mid-America Design Trim

Application Notes:

- Use the -1MD design trim for short panel window frames
- Use the -4116MD design trim for the -4116 window frames
- All design trim is supplied unpainted, ask customer service about custom painted parts
- To maintain color stability, Stylecraft™ and Styleline™ Design Trim should be painted.

Stock	Description
Ruston	
8MD0A9	390-1MD Ruston Stylecraft™ Design Trim
Cathedral	
8MD0D9	393-1MD Cathedral Stylecraft™ Design Trim
Stockton	
8MD0H9	397-1MD Stockton Stylecraft™ Design Trim - 4 Lite
Williamsburg	
8MD0J9	305-1MD Williamsburg Stylecraft™ Design Trim - 4 pc set
Sherwood	
8MD0K9	306-1MD Sherwood Stylecraft™ Design Trim - 2 pc set
Williamsburg	
8MD0L9	405-1MD Williamsburg Stylecraft™ Design Trim - 8 pc set
8MD5L9	405-15MD Williamsburg Stylecraft™ Design Trim - 7 pc set
8MD9L9	405-10MD Williamsburg Stylecraft™ Design Trim - 5 pc set
Cascade	
8MD0M9	591-1MD Cascade Stylecraft™ Design Trim
Stockbridge	
8MD0N9	597-1MD Stockbridge Stylecraft™ Design Trim - 3 Lite
Waterton	
8MD0P9	320-1MD Waterton Stylecraft™ Design Trim
Ashton	
8MD0R9	604-1MD Ashton Stylecraft™ Design Trim
Stockford	
8MD0Z9	697-1MD Stockford Stylecraft™ Design Trim
Stockton Arch	
9MDSL4A9	287-4116MD Stockton Arch Styleline™ Design Trim
Stockton	
9MDSL4D9	387-4116MD Stockton Styleline™ Design Trim
Somerton	
9MDSL4E9	388-4116MD Somerton Styleline™ Design Trim - 2 pc set
Stockbridge	
9MDSL4N9	597-4116MDSL Stockbridge Styleline™ Design Trim - 3 Lite
9MDSL4L9	587-4116MDSL Stockbridge Styleline™ Design Trim - 4 Lite
Wyndbridge	
9MDSL4V9	589-4116MDSL Wyndbridge Styleline™ Design Trim - 3 Lite - 2 pc set
9MDSL4M9	588-4116MDSL Wyndbridge Styleline™ Design Trim - 4 Lite - 2 pc set



405 Williamsburg



405-15 Williamsburg



405-10 Williamsburg



305 Williamsburg



397 Stockton



697 Stockford



393 Cathedral



320 Waterton



306 Sherwood



604 Ashton



390 Ruston



598 Stockbridge



591 Cascade



287 Stockton Rectangular Arch



387 Stockton



388 Somerton



587 Stockbridge - 4 Lite



597 Stockbridge - 3 Lite



588 Wyndbridge - 4 Lite



589 Wyndbridge - 3 Lite



Above illustrations are only representative of actual designs. Actual designs may vary between sizes and manufacturers. The above designs are covered by one or more U.S. Patents. Other U.S. patent applications are pending

Overhead Door Stylecraft™ Design Trim

Application Notes:

- Use the -IOD design trim for the -IOD short panel window frames
- Use the -IOH design trim for the -IOH short panel window frames
- Use the -IWD design trim for the OHD short panel 170 series
- All design trim is supplied unpainted, ask customer service about custom painted parts
- To maintain color stability, Stylecraft™ and Styleline™ Design Trim should be painted.

Stock	Description
Ruston	
8OH0A9	390-1OH Ruston Stylecraft™ Design Trim
8OD0A9	390-1OD Ruston Stylecraft™ Design Trim
8WD0A9	390-1WD Ruston Stylecraft™ Design Trim
Madison	
8OH0B9	391-1OH Madison Stylecraft™ Design Trim
8OD0B9	391-1OD Madison Stylecraft™ Design Trim
8WD0B9	391-1WD Madison Stylecraft™ Design Trim
Winston	
8OH0C9	392-1OH Winston Stylecraft™ Design Trim - 2 pc set
8OD0C9	392-1OD Winston Stylecraft™ Design Trim - 2 pc set
8WD0C9	392-1WD Winston Stylecraft™ Design Trim - 2 pc set
Cathedral	
8OH0D9	393-1OH Cathedral Stylecraft™ Design Trim
8OD0D9	393-1OD Cathedral Stylecraft™ Design Trim
8WD0D9	393-1WD Cathedral Stylecraft™ Design Trim
Stockton	
8OH0H9	397-1OH Stockton Stylecraft™ Design Trim
8OD0H9	397-1OD Stockton Stylecraft™ Design Trim
8WD0H9	397-1WD Stockton Stylecraft™ Design Trim
Williamsburg	
8OH0J9	305-1OH Williamsburg Stylecraft™ Design Trim - 4 pc set
8OD0J9	305-1OD Williamsburg Stylecraft™ Design Trim - 4 pc set
8WD0J9	305-1WD Williamsburg Stylecraft™ Design Trim - 4 pc set
Sherwood	
8OH0K9	306-1OH Sherwood Stylecraft™ Design Trim - 2 pc set
8OD0K9	306-1OD Sherwood Stylecraft™ Design Trim - 2 pc set
8WD0K9	306-1WD Sherwood Stylecraft™ Design Trim - 2 pc set
Williamsburg	
8OH0L9	405-1OH Williamsburg Stylecraft™ Design Trim - 8 pc set
8OD0L9	405-1OD Williamsburg Stylecraft™ Design Trim - 8 pc set
8WD0L9	405-1WD Williamsburg Stylecraft™ Design Trim - 8 pc set
8OH5L9	405-15OH Williamsburg Stylecraft™ Design Trim - 7 pc set
8OD5L9	405-15OD Williamsburg Stylecraft™ Design Trim - 7 pc set
8OH9L9	405-10OH Williamsburg Stylecraft™ Design Trim - 5 pc set
8OD9L9	405-10OD Williamsburg Stylecraft™ Design Trim - 5 pc set
Cascade	
8OH0M9	591-1OH Cascade Stylecraft™ Design Trim
8OD0M9	591-1OD Cascade Stylecraft™ Design Trim
8WD0M9	591-1WD Cascade Stylecraft™ Design Trim
Stockbridge	
8OH0N9	597-1OH Stockbridge Stylecraft™ Design Trim
8OD0N9	597-1OD Stockbridge Stylecraft™ Design Trim
8WD0N9	597-1WD Stockbridge Stylecraft™ Design Trim
Waterton	
8OH0P9	320-1OH Waterton Stylecraft™ Design Trim
8OD0P9	320-1OD Waterton Stylecraft™ Design Trim
8WD0P9	320-1WD Waterton Stylecraft™ Design Trim
Ashton	
8OH0R9	604-1OH Ashton Stylecraft™ Design Trim
8OD0R9	604-1OD Ashton Stylecraft™ Design Trim
8WD0R9	604-1WD Ashton Stylecraft™ Design Trim
Stockford	
8OH0Z9	697-1OH Stockford Stylecraft™ Design Trim
8OD0Z9	697-1OD Stockford Stylecraft™ Design Trim
8WD0Z9	697-1WD Stockford Stylecraft™ Design Trim
Prairie	
7WDSL029	897-1WDSL Prairie Styleline™ Design Trim



405 Williamsburg



405-15 Williamsburg



405-10 Williamsburg



305 Williamsburg



306 Sherwood



392 Winston



897 Prairie



697 Stockford



597 Stockbridge



397 Stockton



320 Waterton



591 Cascade



391 Madison



604 Ashton



390 Ruston



393 Cathedral

Above illustrations are only representative of actual designs. Actual designs may vary between sizes and manufacturers. The above designs are covered by one or more U.S. Patents. Other U.S. patent applications are pending

Direct Dial: (817) 834-7300

Overhead Door Design Trim

Application Notes:

- Use the -3OD design trim for the -3OD long panel window frames
- Use the -3OH design trim for the -3OH long panel window frames
- All design trim is supplied unpainted, ask customer service about custom painted parts
- To maintain color stability, Stylecraft™ and Styleline™ Design Trim should be painted.

Stock	Description
Ruston	
80H2A9	390-3OH Ruston Stylecraft™ Design Trim
80D2A9	390-3OD Ruston Stylecraft™ Design Trim
Madison	
80H2B9	391-3OH Madison Stylecraft™ Design Trim
80D2B9	391-3OD Madison Stylecraft™ Design Trim
Winston	
80H2C9	392-3OH Winston Stylecraft™ Design Trim - 2 pc set
Cathedral	
80H2D9	393-3OH Cathedral Stylecraft™ Design Trim
80D2D9	393-3OD Cathedral Stylecraft™ Design Trim
Stockton	
80H2H9	397-3OH Stockton Stylecraft™ Design Trim - 12 Lite
80D2H9	397-3OD Stockton Stylecraft™ Design Trim - 10 Lite
80D219	387-3ODSL Stockton Styleline™ Design Trim - 8 Lite
80D249	797-3OD Stockton Stylecraft™ Design Trim - 4 Lite
80D234C9	799-3ODSL Stockton Styleline™ Design Trim - 6 Lite
Williamsburg	
80H2J9	305-3OH Williamsburg Stylecraft™ Design Trim - 2 pc set
80D2J9	305-3OD Williamsburg Stylecraft™ Design Trim - 2 pc set
Sherwood	
80H2K9	306-3OH Sherwood Stylecraft™ Design Trim
80D2K9	306-3OD Sherwood Stylecraft™ Design Trim
Williamsburg	
80H2L9	405-3OH Williamsburg Stylecraft™ Design Trim - 4pc set
80D2L9	405-3OD Williamsburg Stylecraft™ Design Trim - 4 pc set
Cascade	
80H2M9	591-3OH Cascade Stylecraft™ Design Trim
80D2M9	591-3OD Cascade Stylecraft™ Design Trim
Stockbridge	
80H2N9	597-3OH Stockbridge Stylecraft™ Design Trim - 3 Lite
90HSL2N9	597-3OHSL Stockbridge Styleline™ Design Trim - 3 Lite
80D2N9	597-3OD Stockbridge Stylecraft™ Design Trim - 3 Lite
80H2Q9	587-3OHSL Stockbridge Styleline™ Design Trim - 4 Lite
80D2Q9	587-3OD Stockbridge Stylecraft™ Design Trim - 4 Lite
Waterton	
80H2P9	320-3OH Waterton Stylecraft™ Design Trim
80D2P9	320-3OD Waterton Stylecraft™ Design Trim
Ashton	
80H2R9	604-3OH Ashton Stylecraft™ Design Trim
80D2R9	604-3OD Ashton Stylecraft™ Design Trim
Stockford	
80D2Z9	697-3OD Stockford Stylecraft™ Design Trim
Prairie	
80D229	897-3OD Prairie Stylecraft™ Design Trim
7WDSL229	897-3WDSL Prairie Styleline™ Design Trim
Stockton Arch	
80D269	287-3OD Stockton Rectangular Arch Stylecraft™ Design Trim
80H269	287-3OHSL Stockton Rectangular Arch Styleline™ Design Trim
Wyndbridge	
80H2T9	588-3OHSL Wyndbridge Styleline™ Design Trim - 2 pc set
80D2T9	588-3OD Wyndbridge Stylecraft™ Design Trim - 2 pc set
Somerton	
80H2U9	388-3OHSL Somerton Styleline™ Design Trim - 2 pc set
80D23359	388-3ODSL Somerton Styleline™ Design Trim - 2 pc set



405-3 Williamsburg



305-3 Williamsburg



392-3 Winston



588-3 Wyndbridge



388-3 Somerton



306-3 Sherwood

604-3 Ashton



393-3 Cathedral

391-3 Madison



390-3 Ruston

591-3 Cascade



587-3 Stockbridge

597-3 Stockbridge



397-3 Stockton 12 Lite

397-3 Stockton 10 Lite



287-3 Stockton Arch

797-3 Stockton



799-3 Stockton

387-3 Stockton



897-3 Prairie

697-3 Stockford



320-3 Waterton

Above illustrations are only representative of actual designs. Actual designs may vary between sizes and manufacturers. The above designs are covered by one or more U.S. Patents. Other U.S. patent applications are pending

Email: sales@natdoor.com



Richards-Wilcox Design Trim

Application Notes:

- Use the -1RWS design trim for short panel window frames
- Use the -3RWS design trim for long panel window frames
- All design trim is supplied unpainted, ask customer service about custom painted parts
- To maintain color stability, Stylecraft™ Design Trim should be painted.

Stock	Description
Ruston	
8RW0A9	390-1RWS Ruston Stylecraft™ Design Trim
8RW2A9	390-3RWS Ruston Stylecraft™ Design Trim
Cathedral	
8RW0D9	393-1RWS Cathedral Stylecraft™ Design Trim
8RW2D9	393-3RWS Cathedral Stylecraft™ Design Trim
Stockton	
8RW0H9	397-1RWS Stockton Stylecraft™ Design Trim
8RW2H9	397-3RWS Stockton Stylecraft™ Design Trim
Williamsburg	
8RW0J9	305-1RWS Williamsburg Stylecraft™ Design Trim - 4 pc set
8RW2J9	305-3RWS Williamsburg Stylecraft™ Design Trim - 2 pc set
Sherwood	
8RW0K9	306-1RWS Sherwood Stylecraft™ Design Trim - 2 pc set
8RW2K9	306-3RWS Sherwood Stylecraft™ Design Trim
Williamsburg	
8RW0L9	405-1RWS Williamsburg Stylecraft™ Design Trim - 8 pc set
8RW2L9	405-3RWS Williamsburg Stylecraft™ Design Trim - 4 pc set
8RW5L9	405-15RWS Williamsburg Stylecraft™ Design Trim - 7 pc set
8RW9L9	405-10RWS Williamsburg Stylecraft™ Design Trim - 5 pc set
Cascade	
8RW0M9	591-1RWS Cascade Stylecraft™ Design Trim
8RW2M9	591-3RWS Cascade Stylecraft™ Design Trim
Stockbridge	
8RW0N9	597-1RWS Stockbridge Stylecraft™ Design Trim
8RW2N9	597-3RWS Stockbridge Stylecraft™ Design Trim
Waterton	
8RW0P9	320-1RWS Waterton Stylecraft™ Design Trim
8RW2P9	320-3RWS Waterton Stylecraft™ Design Trim
Ashton	
8RW0R9	604-1RWS Ashton Stylecraft™ Design Trim
8RW2R9	604-3RWS Ashton Stylecraft™ Design Trim
Stockford	
8RW0Z9	697-1RWS Stockford Stylecraft™ Design Trim
8RW2Z9	697-3RWS Stockford Stylecraft™ Design Trim



405 Williamsburg



405-3 Williamsburg



405-15 Williamsburg



405-10 Williamsburg



305 Williamsburg



305 Williamsburg



697 Stockford



697 Stockford



320 Waterton



320 Waterton



390 Ruston



390 Ruston



604 Ashton



604 Ashton



393 Cathedral



393 Cathedral



397 Stockton



397 Stockton



597 Stockbridge



597 Stockbridge



591 Cascade



591 Cascade



306 Sherwood



306 Sherwood

Above illustrations are only representative of actual designs. Actual designs may vary between sizes and manufacturers. The above designs are covered by one or more U.S. Patents. Other U.S. patent applications are pending.

Direct Dial: (817) 834-7300

Windsor Design Trim

Application Notes:

- Use the -1WIS design trim for the -1WI short panel window frames
- Use the -3WIS design trim for the -3WI long panel window frames
- Use the -6WIS design trim for the -6WI long panel window frames
- All design trim is supplied unpainted, ask customer service about custom painted parts
- To maintain color stability, Stylecraft™ Design Trim should be painted.

Stock	Description
Ruston	
8WI0A9	390-1WIS Ruston Stylecraft™ Design Trim
8WI2A9	390-3WIS Ruston Stylecraft™ Design Trim
8WI8A9	390-6WIS Ruston Stylecraft™ Design Trim
Madison	
8WI0B9	391-1WIS Madison Stylecraft™ Design Trim
8WI2B9	391-3WIS Madison Stylecraft™ Design Trim
8WI8B9	391-6WIS Madison Stylecraft™ Design Trim
Winston	
8WI0C9	392-1WIS Winston Stylecraft™ Design Trim - 2 pc set
Cathedral	
8WI0D9	393-1WIS Cathedral Stylecraft™ Design Trim
8WI2D9	393-3WIS Cathedral Stylecraft™ Design Trim
8WI8D9	393-6WIS Cathedral Stylecraft™ Design Trim
Stockton	
8WI0H9	397-1WIS Stockton Stylecraft™ Design Trim - 4 Lite
8WI2I9	387-3WIS Stockton Stylecraft™ Design Trim - 8 Lite
8WI2H9	397-3WIS Stockton Stylecraft™ Design Trim - 12 Lite
8WI8H9	397-6WIS Stockton Stylecraft™ Design Trim - 12 Lite
Williamsburg	
8WI0J9	305-1WIS Williamsburg Stylecraft™ Design Trim - 4 pc set
8WI2J9	305-3WIS Williamsburg Stylecraft™ Design Trim - 2 pc set
8WI8J9	305-6WIS Williamsburg Stylecraft™ Design Trim - 2 pc set
Sherwood	
8WI0K9	306-1WIS Sherwood Stylecraft™ Design Trim - 2 pc set
8WI2K9	306-3WIS Sherwood Stylecraft™ Design Trim
8WI8K9	306-6WIS Sherwood Stylecraft™ Design Trim
Williamsburg	
8WI0L9	405-1WIS Williamsburg Stylecraft™ Design Trim - 8 pc set
8WI2L9	405-3WIS Williamsburg Stylecraft™ Design Trim - 4 pc set
8WI8L9	405-6WIS Williamsburg Stylecraft™ Design Trim - 4 pc set
8WI5L9	405-15WIS Williamsburg Stylecraft™ Design Trim - 7 pc set
8WI9L9	405-10WIS Williamsburg Stylecraft™ Design Trim - 5 pc set
Cascade	
8WI0M9	591-1WIS Cascade Stylecraft™ Design Trim
8WI2M9	591-3WIS Cascade Stylecraft™ Design Trim
8WI8M9	591-6WIS Cascade Stylecraft™ Design Trim
Stockbridge	
8WI0N9	597-1WIS Stockbridge Stylecraft™ Design Trim - 3 Lite
8WI2N9	597-3WIS Stockbridge Stylecraft™ Design Trim - 3 Lite
8WI239	597-3WIS Stockbridge Stylecraft™ Design Trim - 5 Lite
8WI8N9	597-6WIS Stockbridge Stylecraft™ Design Trim - 3 Lite
Waterton	
8WI0P9	320-1WIS Waterton Stylecraft™ Design Trim
8WI2P9	320-3WIS Waterton Stylecraft™ Design Trim
8WI8P9	320-6WIS Waterton Stylecraft™ Design Trim
Ashton	
8WI0R9	604-1WIS Ashton Stylecraft™ Design Trim
8WI2R9	604-3WIS Ashton Stylecraft™ Design Trim
8WI8R9	604-6WIS Ashton Stylecraft™ Design Trim
Stockford	
8WI0Z9	697-1WIS Stockford Stylecraft™ Design Trim
8WI2Z9	697-3WIS Stockford Stylecraft™ Design Trim
Somerton	
8WI2U9	388-3WIS Somerton Stylecraft™ Design Trim - 2 pc set

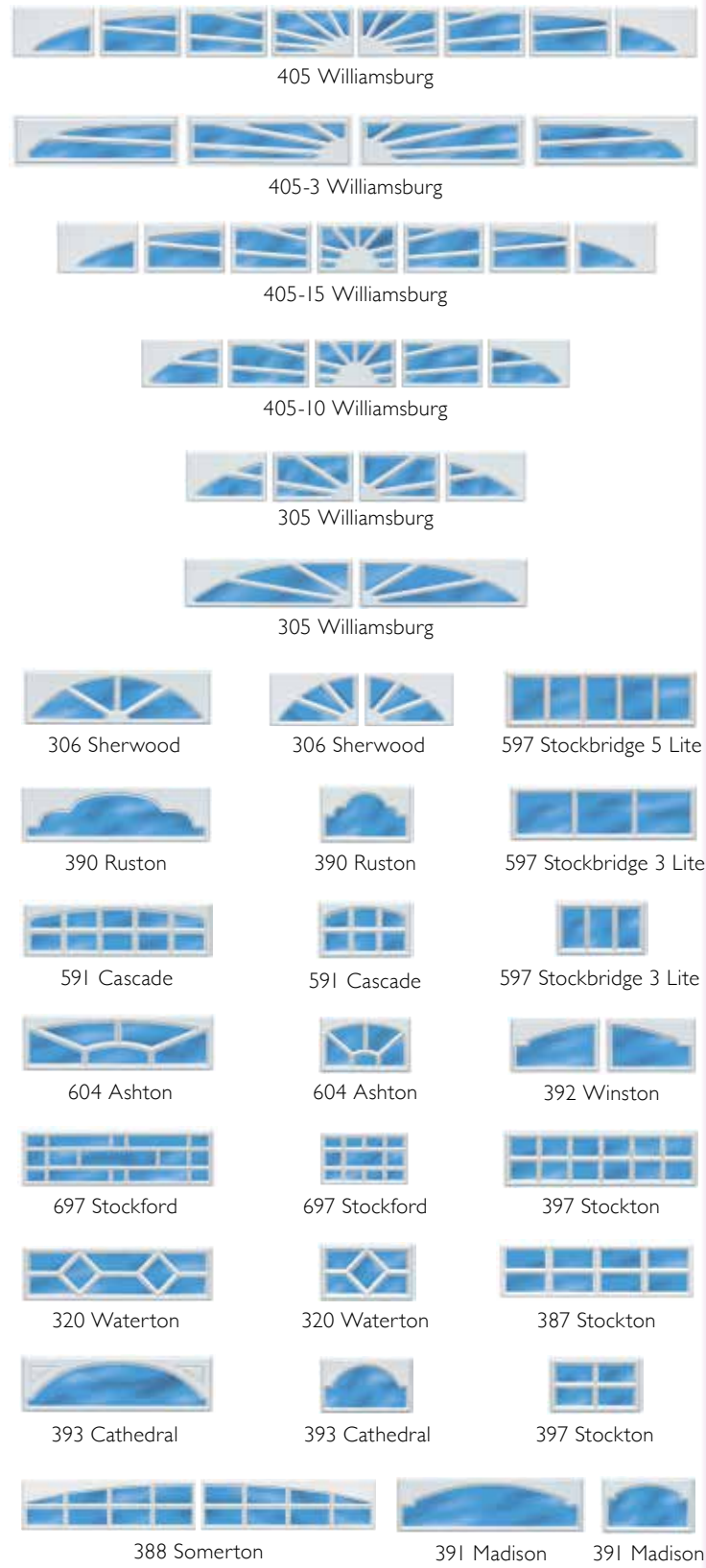

Above illustrations are only representative of actual designs. Actual designs may vary between sizes and manufacturers. The above designs are covered by one or more U.S. Patents. Other U.S. patent applications are pending

Email: sales@natdoor.com



Carriage Door Trim

- All design trim is supplied unpainted, ask customer service about custom painted parts
- To maintain color stability, Stylecraft™ and Styleline™ Design Trim should be painted.

- Will fit 18", 21", 24" tall sections.
- Will fit National Door's CFR Carriage Frames and/or Overhead Door's Courtyard series frames.

Styleline™ Design Trim

Stock	Description
Stockton Arch	
9WDSL2G309	287-3311WDSL Stockton Arch Styleline™ Design Trim
9WDSL2J309	287-3611WDSL Stockton Arch Styleline™ Design Trim
9WDSL2M309	287-4211WDSL Stockton Arch Styleline™ Design Trim
9WDSL2P309	287-4811WDSL Stockton Arch Styleline™ Design Trim
Stockton	
9WDSL2G349	387-3311WDSL Stockton Styleline™ Design Trim - 8 Lite
9WDSL2J349	387-3611WDSL Stockton Styleline™ Design Trim - 8 Lite
9WDSL2M349	387-4211WDSL Stockton Styleline™ Design Trim - 8 Lite
9WDSL2P349	387-4811WDSL Stockton Styleline™ Design Trim - 8 Lite
Somerton	
9WDSL2G359	388-3311WDSL Somerton Styleline™ Design Trim - 8 Lite
9WDSL2J359	388-3611WDSL Somerton Styleline™ Design Trim - 8 Lite
9WDSL2M359	388-4211WDSL Somerton Styleline™ Design Trim - 8 Lite
9WDSL2P359	388-4811WDSL Somerton Styleline™ Design Trim - 8 Lite
Stockbridge	
9WDSL2G3G9	587-3311WDSL Stockbridge Styleline™ Design Trim - 4 Lite
9WDSL2J3G9	587-3611WDSL Stockbridge Styleline™ Design Trim - 4 Lite
9WDSL2M3G9	587-4211WDSL Stockbridge Styleline™ Design Trim - 4 Lite
9WDSL2P3G9	587-4811WDSL Stockbridge Styleline™ Design Trim - 4 Lite
Wyndbridge	
9WDSL2G3J9	588-3311WDSL Wyndbridge Styleline™ Design Trim - 4 Lite
9WDSL2J3J9	588-3611WDSL Wyndbridge Styleline™ Design Trim - 4 Lite
9WDSL2M3J9	588-4211WDSL Wyndbridge Styleline™ Design Trim - 4 Lite
9WDSL2P3J9	588-4811WDSL Wyndbridge Styleline™ Design Trim - 4 Lite

Stylecraft™ Design Trim

Stock	Description
Stockton Arch	
8CD0A9	287-1713 Stockton Arch Stylecraft™ Design Trim
8CD0B9	287-2013 Stockton Arch Stylecraft™ Design Trim
8CD0D9	287-3513 Stockton Arch Stylecraft™ Design Trim
8CD0E9	287-3813 Stockton Arch Stylecraft™ Design Trim
8CD0F9	287-4413 Stockton Arch Stylecraft™ Design Trim
8CD0G9	287-5013 Stockton Arch Stylecraft™ Design Trim
Stockton	
8CD1A9	387-1713 Stockton Stylecraft™ Design Trim - 4 Lite
8CD1B9	387-2013 Stockton Stylecraft™ Design Trim - 4 Lite
8CD1D9	387-3513 Stockton Stylecraft™ Design Trim - 8 Lite
8CD1E9	387-3813 Stockton Stylecraft™ Design Trim - 8 Lite
8CD1F9	387-4413 Stockton Stylecraft™ Design Trim - 8 Lite
8CD1G9	387-5013 Stockton Stylecraft™ Design Trim - 8 Lite
Somerton	
8CD2D9	388-3513 Somerton Stylecraft™ Design Trim - 8 Lite
8CD2E9	388-3813 Somerton Stylecraft™ Design Trim - 8 Lite
8CD2F9	388-4413 Somerton Stylecraft™ Design Trim - 8 Lite
8CD2G9	388-5013 Somerton Stylecraft™ Design Trim - 8 Lite
Stockbridge	
8CD3A9	587-1713 Stockbridge Stylecraft™ Design Trim - 2 Lite
8CD3B9	587-2013 Stockbridge Stylecraft™ Design Trim - 2 Lite
8CD3D9	587-3513 Stockbridge Stylecraft™ Design Trim - 4 Lite
8CD3E9	587-3813 Stockbridge Stylecraft™ Design Trim - 4 Lite
8CD3F9	587-4413 Stockbridge Stylecraft™ Design Trim - 4 Lite
8CD3G9	587-5013 Stockbridge Stylecraft™ Design Trim - 4 Lite
Wyndbridge	
8CD4D9	588-3513 Wyndbridge Stylecraft™ Design Trim - 4 Lite
8CD4E9	588-3813 Wyndbridge Stylecraft™ Design Trim - 4 Lite
8CD4F9	588-4413 Wyndbridge Stylecraft™ Design Trim - 4 Lite
8CD4G9	588-5013 Wyndbridge Stylecraft™ Design Trim - 4 Lite

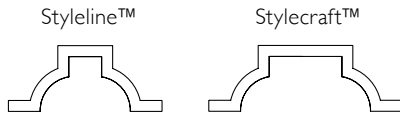

Above illustrations are only representative of actual designs. Actual designs may vary between sizes and manufacturers. The above designs are covered by one or more U.S. Patents. Other U.S. patent applications are pending

Carriage Door Trim

- All design trim is supplied unpainted, ask customer service about custom painted parts
- To maintain color stability, Stylecraft™ and Styleline™ Design Trim should be painted.

- Will fit 18", 21", 24" tall sections.
- Will fit National Door's CFR Carriage Frames and/or Overhead Door's Courtyard series frames.

Styleline™ Design Trim

Stock	Description
Stockton Arch	
9WDSL2H309	287-3314WDSL Stockton Arch Styleline™ Design Trim
9WDSL2K309	287-3614WDSL Stockton Arch Styleline™ Design Trim
9WDSL2N309	287-4214WDSL Stockton Arch Styleline™ Design Trim
9WDSL2Q309	287-4814WDSL Stockton Arch Styleline™ Design Trim
Stockton	
9WDSL2H349	387-3314WDSL Stockton Styleline™ Design Trim - 8 Lite
9WDSL2K349	387-3614WDSL Stockton Styleline™ Design Trim - 8 Lite
9WDSL2N349	387-4214WDSL Stockton Styleline™ Design Trim - 8 Lite
9WDSL2Q349	387-4814WDSL Stockton Styleline™ Design Trim - 8 Lite
Somerton	
9WDSL2H359	388-3314WDSL Somerton Styleline™ Design Trim - 8 Lite
9WDSL2K359	388-3614WDSL Somerton Styleline™ Design Trim - 8 Lite
9WDSL2N359	388-4214WDSL Somerton Styleline™ Design Trim - 8 Lite
9WDSL2Q359	388-4814WDSL Somerton Styleline™ Design Trim - 8 Lite
Stockbridge	
9WDSL2H3G9	587-3314WDSL Stockbridge Styleline™ Design Trim - 4 Lite
9WDSL2K3G9	587-3614WDSL Stockbridge Styleline™ Design Trim - 4 Lite
9WDSL2N3G9	587-4214WDSL Stockbridge Styleline™ Design Trim - 4 Lite
9WDSL2Q3G9	587-4814WDSL Stockbridge Styleline™ Design Trim - 4 Lite
Wyndbridge	
9WDSL2H3J9	588-3314WDSL Wyndbridge Styleline™ Design Trim - 4 Lite
9WDSL2K3J9	588-3614WDSL Wyndbridge Styleline™ Design Trim - 4 Lite
9WDSL2N3J9	588-4214WDSL Wyndbridge Styleline™ Design Trim - 4 Lite
9WDSL2Q3J9	588-4814WDSL Wyndbridge Styleline™ Design Trim - 4 Lite

Stylecraft™ Design Trim

Stock	Description
Stockton Arch	
8CD0R9	287-1716 Stockton Arch Stylecraft™ Design Trim
8CD0S9	287-2016 Stockton Arch Stylecraft™ Design Trim
8CD0U9	287-3516 Stockton Arch Stylecraft™ Design Trim
8CD0V9	287-3816 Stockton Arch Stylecraft™ Design Trim
8CD0W9	287-4416 Stockton Arch Stylecraft™ Design Trim
8CD0X9	287-5016 Stockton Arch Stylecraft™ Design Trim
Stockton	
8CD1R9	387-1716 Stockton Stylecraft™ Design Trim - 4 Lite
8CD1S9	387-2016 Stockton Stylecraft™ Design Trim - 4 Lite
8CD1U9	387-3516 Stockton Stylecraft™ Design Trim - 8 Lite
8CD1V9	387-3816 Stockton Stylecraft™ Design Trim - 8 Lite
8CD1W9	387-4416 Stockton Stylecraft™ Design Trim - 8 Lite
8CD1X9	387-5016 Stockton Stylecraft™ Design Trim - 8 Lite
Somerton	
8CD2U9	388-3516 Somerton Stylecraft™ Design Trim - 8 Lite
8CD2V9	388-3816 Somerton Stylecraft™ Design Trim - 8 Lite
8CD2W9	388-4416 Somerton Stylecraft™ Design Trim - 8 Lite
8CD2X9	388-5016 Somerton Stylecraft™ Design Trim - 8 Lite
Stockbridge	
8CD3R9	587-1716 Stockbridge Stylecraft™ Design Trim - 2 Lite
8CD3S9	587-2016 Stockbridge Stylecraft™ Design Trim - 2 Lite
8CD3U9	587-3516 Stockbridge Stylecraft™ Design Trim - 4 Lite
8CD3V9	587-3816 Stockbridge Stylecraft™ Design Trim - 4 Lite
8CD3W9	587-4416 Stockbridge Stylecraft™ Design Trim - 4 Lite
8CD3X9	587-5016 Stockbridge Stylecraft™ Design Trim - 4 Lite
Wyndbridge	
8CD4U9	588-3516 Wyndbridge Stylecraft™ Design Trim - 4 Lite
8CD4V9	588-3816 Wyndbridge Stylecraft™ Design Trim - 4 Lite
8CD4W9	588-4416 Wyndbridge Stylecraft™ Design Trim - 4 Lite
8CD4X9	588-5016 Wyndbridge Stylecraft™ Design Trim - 4 Lite

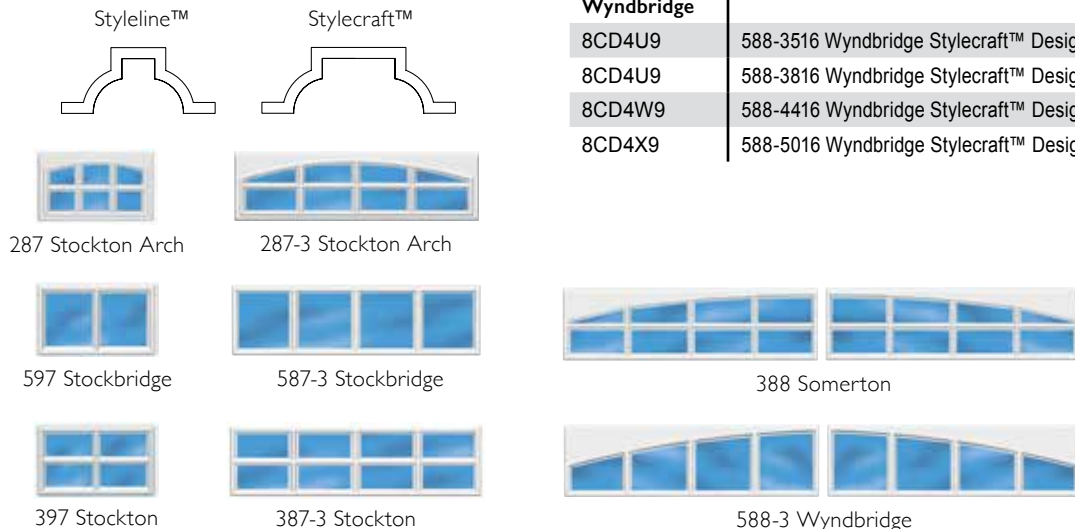

Above illustrations are only representative of actual designs. Actual designs may vary between sizes and manufacturers. The above designs are covered by one or more U.S. Patents. Other U.S. patent applications are pending

GATE OPERATORS

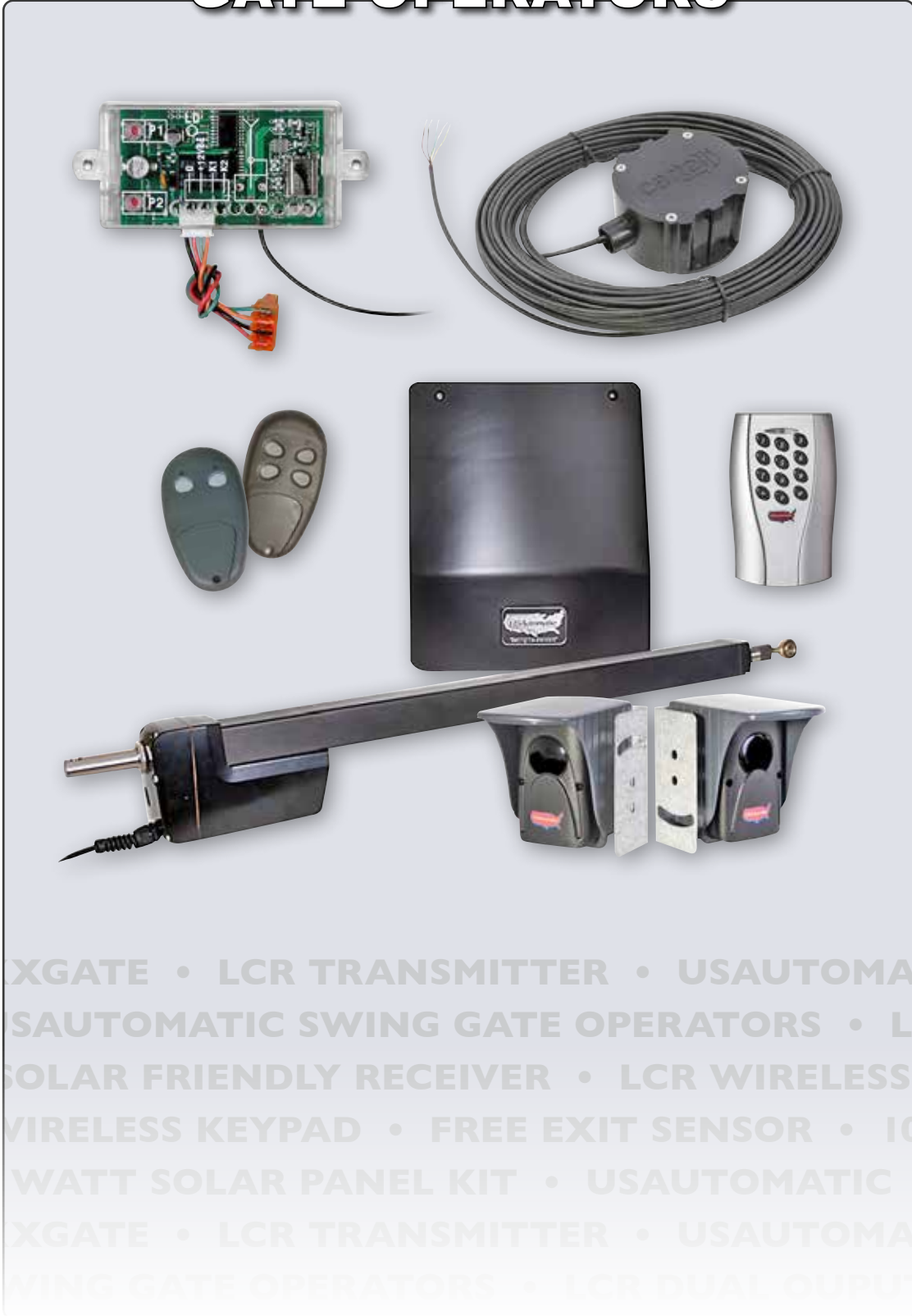

XGATE • LCR TRANSMITTER • USAUTOMA
SAUTOMATIC SWING GATE OPERATORS • L
SOLAR FRIENDLY RECEIVER • LCR WIRELESS
WIRELESS KEYPAD • FREE EXIT SENSOR • IC
WATT SOLAR PANEL KIT • USAUTOMATIC
XGATE • LCR TRANSMITTER • USAUTOMA
WING GATE OPERATORS • LCR DUAL GUPU

GATE OPERATORS

Direct Dial: (817) 834-7300

USAutomatic Swing Gate Operators

For residential, light commercial, farm and ranch use

- Battery powered charged with AC or SOLAR
- Swing Gates Up To 16 Feet And 800 Lbs.

Patriot

Battery powered charged with AC or SOLAR
For residential, light commercial, farm and ranch use

- Stainless steel actuator
- Selectable soft stop
- Independent gate 1 and gate 2 sensitivity adjustments
- Single or dual gate compatible
- Designed to operate with all types of accessories
- Photo eye transmitter is battery powered or hardwired
- Photo eye power management (PEPM) solar friendly software
- Battery powered providing real battery backup.
- Gate travel speed ~ 12 seconds
- 5 year warranty on control board
- 3 year warranty on other components



Ranger HD

- Non-corrosive actuator and control box
- Battery under load monitoring
- Low battery audible notification
- PWM soft start and soft stop
- "Gate APP" compatible from USAutomatic powered by Nexx
- Electronic limit control on board
- Independent gate 1 and gate 2 sensitivity adjustments
- Single or dual gate compatible
- Designed to operate with all types of accessories
- Photo eye transmitter is battery powered or hardwired
- Photo eye power management (PEPM) solar friendly software
- Battery powered providing real battery backup. Not just 1 cycle
- Gate travel speed ~ 12 seconds
- Optional galvanized box available
- Backed by a 3 year warranty



Stock	Description
I57400	Patriot 1, Solar, US Automatic - single gate
I57402	Patriot 2, Solar, US Automatic - double gate
I57410	Ranger HD 1, Solar, US Automatic - single gate
I57412	Ranger HD 2, Solar, US Automatic - double gate
I57420	Patriot RSL Slider, Solar, US Automatic - sliding gate
I57450-AC	Patriot 1, AC, US Automatic - single gate
I57452-AC	Patriot 2, AC, US Automatic - double gate
I57460-AC	Ranger HD 1, AC, US Automatic - single gate
I57462-AC	Ranger HD 2, AC, US Automatic - double gate
I57470-AC	Patriot RSL Slider, AC, US Automatic - sliding gate

Both Operators Include These Components:

- Heavy duty-12V DC - 24 in. stroke linear actuator
 - Pre-wired solar friendly LCR dual channel receiver
 - 2 - LCR 2 button transmitters included.
 - Mounting hardware
 - Photo eye - through beam for reliability
 - Battery charger (AC or solar)
- *Solar option allows for remote installation

USAutomatic ACCESSORIES

Designed for use with usaautomatic control boards

LCR Dual Output Solar Friendly Receiver

Standard receiver for all USAutomatic operators

- Capable of storing 42 unique transmitter codes
- Learn button for programming
- Two relays - Primary relay momentary, secondary relay has momentary or latching mode

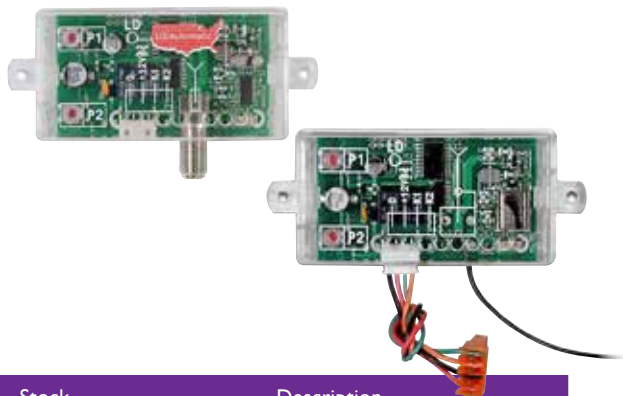

Stock	Description
I57500	LCR Low Current Receiver, US Automatic
I57510	Ranger LCR Low Current Receiver, US Automatic

Free Exit Sensor

- Opens gate automatically when leaving property
- Can open gate up to 100 feet away
- No programming necessary
- Installs next to driveway instead of under



Stock	Description
I57550	Free Exit Sensor

Additional Accessories

Stock	Description
I57540	LCR Wireless Push To Operate Button (outdoor)
I57542	LCR Garage Door Receiver (Transformer, Harness included)
I57544	Coax Antenna Extension Kit (Includes Bracket & 12 Feet Coax)
I57546	LCR Pack (Includes LCR 030205 receiver, Antenna Bracket, 2 remotes, 12 Feet Coax and Antenna) Solar Friendly
I57610	Solar Panel Cable Extension 75 ft
I57612	Y-Cable Solar Charging (for dual solar panels)
I57614	Battery Charge Controller, 120 watt, US Automatic

LCR wireless keypad

- Operating Frequency 433.92 Mhz
- 2 to 5 digit Access Codes
- Capable of storing 1 to 24 different access codes
- Access code can be programmed to either primary relay 1 or secondary relay 2



Metal lights up on contact!

Stock	Description
I57530	Keypad, Plastic case, US Automatic
I57532	Keypad, Metal case, US Automatic

10 Watt Solar Panel Kit

- 15 ft Plug N Go cable included
- No wiring required
- Environmentally Friendly
- Contains mounting bracket and hardware



Stock	Description
I57600-10	10 watt Solar panel, US Automatic4
I57600-20	20 watt Solar panel, US Automatic

USAutomatic Nexxgate

- Open/close gate operator
- Remote control via Nexx Home app
- Works with Alexa and Google Assistant enabled devices
- Best-in-class encryption technology Compatible with USAutomatic Gate Operators



Stock	Description
I57548	Nexx Gate

LCR Transmitter

Standard transmitter with all USAutomatic operators

- Operating Frequency 433.92 MHz
- 12/24V DC garage door receiver available

Stock	Description
I57520	Transmitter 2-button, US Automatic
I57525	Transmitter 4-button, US Automatic



Direct Dial: (817) 834-7300

Terms and Conditions of Sale

ORDERING INFORMATION

National Door Industries is always pleased to receive your order and always to fill it as promptly as possible. If you will note the following about placing your order, it will help us serve you more efficiently.

Who May Buy

National Door is a wholesale manufacturer and supplier. Possession of this list or any other National Door literature does not constitute an offer to sell. Orders from individuals will not be accepted, as we only sell to professional tradesman in the garage door industry who sell, service, install, and/or repair garage doors.

Minimum Order Charge

The minimum order amount is \$25.00. Orders for merchandise totaling less than that, will be billed at \$25.00.

Methods of Ordering

You can order from National Door in a number of ways. We have listed a few.

1. Phone 817-834-7300

Our Sales Department is open 7:30 am to 5:00 pm Central Standard Time. When the operator answers, ask for the Sales Department.

2. Toll Free FAX 817-831-8812

You can send us your order via fax 24 hours a day.

3. Online Ordering

You can place orders online if you have set up an online account with us. Visit us at www.natdoor.com to register and place an order. If you have not set up an online account with us already, you will need to fill out the Electronic Commerce Agreement. You can also print it from our website at www.natdoor.com

4. E-Mail

You can e-mail your orders to sales@natdoor.com or directly to one of our Sales Representatives.

5. Customer Pick Up ("Will Call") 8:00am to 4:30pm, Monday thru Friday

The purpose of Will Call is to give our customers, local and out of town, immediate service. We make every effort to process your Will Call Order as fast as possible. We find you can save time by calling in your order ahead of time. This gives us a chance to process and pull your order before you arrive. By checking stock when you call, you will know if what you want is in stock, and will be waiting for you. Your cooperation is appreciated.

INTERNATIONAL ORDERS

Prices quoted are in U.S. dollars only. The customer is responsible for all duties, taxes, freight and postage charges incurred in shipment(s). The Export Department will prepare all necessary Customs documents.

Outside North America

National Door's sales personnel are experienced

in the proper handling of international orders, inquiries and quotations. The preferred method of payment for all international orders is wire transfer or credit card. There will be a bank handling charge added to all wire transfers. Export shipments are normally made via LCL, air cargo, air or parcel post. Since ocean freight shipments need special packaging, a separate charge for this service will be added.

PLACING AN ORDER

Customer Information

We have listed below the information needed to place an order for the two types of accounts.

1. Established Accounts

Whenever you place an order, we need the following:

- Company Name (as ordered previously)
- Phone Number

If you have changed your company name, address, or phone number since your last order, let us know. We must keep our records up to date so we can best serve you.

2. New Accounts

If you are placing your first order with National Door, we will need to know the following so we can correctly set up your account.

- Company Name (full legal name and division)
- Owners' Name
- Billing and Shipping Address
- Phone Number
- Industry suppliers used
- Resale Certificate if Tax Exempt in your state
- Email Address
- How you want to receive Order Confirmations and Invoices

PURCHASE ORDERS

Please provide a purchase order number for each order you place. This allows us to keep better records of all outstanding orders. If you do not use purchase orders, the name, date and/or the person placing the order is acceptable. Please refrain from sending purchase orders using multiple methods, as we cannot be responsible for duplicate orders not marked as DUPLICATE.

Product Information Needed

When placing an order for products listed in the National catalog, it is very important that you use the complete part numbers. Since every product shown has a specific SKU number, it is the best way to insure you receive the products you want. The preferred method for specifying individual products when ordering is:

Quantity—Tell us how many you want. Be sure to specify the unit of measure.

Stock number—Use the stock numbers shown in the catalog or website for the particular products you want.

Description—Give us a short description of the product. Include color, size, etc.

For example, to order a Case of National Door Lubricant, specify:

1 case 100005 #400HD-15oz Door Lube (qty/unit) (stk No.) (description)

Other Information Needed

When placing your order, please be sure to tell us of any special requirements you may have for your order in regards to shipping. Is there a specific carrier or date to ship the merchandise out on?

MERCHANDISE OUT OF STOCK

Sometimes we will be out of stock of a particular product you have ordered. We make every effort to prevent back orders, but realize there will be back orders and hope you will understand.

Special Quotes & Volume Orders

Special quotes and orders for merchandise will be made upon request. All special order merchandise is considered non-cancelable and cannot be returned for credit. A written purchase order from your company may be requested at our discretion.

Our price list shows how we universally sell our products. For special prices or volume orders, contact our Sales Department.

ACCOUNTING INFORMATION

Our goal is prompt and courteous service to our customers.

Credit Department

The Credit Department will help you in the areas of incorrect balances, invoice adjustments, service charges and sales tax credits.

The Credit Department will supply you with copies of statements or invoices and information on accounts.

Credit Memos

The Credit Department can answer your questions regarding credits for returned merchandise, sales tax credits, duplicate billings, and credit balances.

New Accounts

If you have applied for an open account but have not heard from us yet, ask for the Credit Department.

Updating Customer Account Information

It is important that we have the most current and accurate information regarding your account. If you have changed your firm name, shipping and/or billing address, or phone number, please let us know as soon as possible.

Pricing

All pricing is subject to change without notice. Due to conditions and inflation, we cannot guarantee the prices shown in our price list. All merchandise will be invoiced at the time of shipment.

Email: sales@natdoor.com



Terms and Conditions of Sale

Returns Guidelines

We at National Door have established a fair and equitable return policy for our customers. We have established the following guidelines for the return of regular catalog merchandise.

Returned Material Authorization (RMA)

When you need to return something to us, call our Customer Service Department and explain the situation. If returnable, we will email you an RMA. If National Door is to pay for the return freight, we ask you to help keep costs down by following the shipping instructions on the RMA. Normally returns will be made via UPS or Common Carrier Motor Freight. We will furnish our completed bill of lading for Motor Freight returns, properly coded, along with instructions for palletizing, or for other specific instructions necessary when preparing a return shipment. Please follow these instructions carefully, so that we do not have unauthorized freight charges, or damaged merchandise which you could be responsible for. Make sure you note the RMA number and the original invoice number on each carton you return. Returns are not allowed on tools that have been used. No C.O.D. returns will be accepted.

1. No Fault Returns

Anything you buy from us that is stock merchandise, and which is in new, resaleable condition, can be returned by calling and obtaining a RMA. If you ask for the RMA within 30 days of the invoice date there will be no restocking charge. The RMA must be used within 30 days of issue, and return freight is your responsibility. Please remember that when you want to return items under this "No Fault" policy, the invoice is still due and payable according to terms. Once we have received the material, inspected, and approved it for return to stock, we will process a credit.

2. 31 to 90 Days

If you need an RMA for merchandise that is over 30 days old from the invoice date, there will be a 15% restocking charge. Also, any special order items ordered or made for you cannot be returned. No freight credit allowed. All returns are subject to approval.

3. 91 Days and Over

Items more than 90 days old from invoice date cannot be returned.

Returns Due to National Door Error

As hard as we try, occasionally there may be an error in what we ship you. When this happens let us know right way, at least within 30 days of the invoice date where possible so we can correct any problems quickly. We will send you a RMA and UPS label for the return. Once the material is returned and inspected, we will credit you for 100% of the material plus all inbound and outbound freight charges authorized. If you ask to return something that is 30 days old, or if we receive a return from you it has been damaged or abused, we may have to charge a restocking fee, and/or reboxing fee, or depending on the

circumstances, we may not be able to issue any credit.

Inspections

When we accept a return from you, we will carefully inspect it to make sure it is in resaleable condition or to find out if there is any problem with it. If it is a "no fault" credit and the material is resaleable, we will issue credit. If the material is an error return, once we confirm the error and get it corrected we will issue credit. If something is returned which has been damaged due to abuse, misuse, carelessness or neglect we will not be able to issue credit.

Special Ordered or Manufactured Merchandise

Special ordered or fabricated items must be on written purchase orders. They are not returnable for credit. Special ordered or manufactured merchandise can only be cancelled with the written approval of National Door, and then only after we determine from the manufacturer that production can be stopped and/or the order has not already been processed.

TERMS OF SALE

Terms & Credit Policy for Open Account Customers

These terms and conditions are in effect at the time of publication of this catalog and are subject to change without notice. National Door Industries, Inc. gladly extends credit terms to firms in the garage door industry. You must agree to pay invoices due, according to the terms.

Payments should be made to :

National Door Industries, Inc.
6310 Airport Freeway
Fort Worth, TX 76117

The following are invoice payment policies for open account customers:

Net 30 - All invoices are due Net 30 ADI (After Date of Invoice) unless otherwise indicated on the invoice. Any account with invoices past due, may cause the account to be put on credit hold.

CIA—Cash In Advance

In certain cases, an account must send prepayment for merchandise ordered. This occurs if normal open or C.O.D. account privileges have been abused, or to save C.O.D. fees. Cash in advance prepayments must be mailed to :

National Door Industries, Inc.
6310 Airport Frwy
Fort Worth, TX 76117

Returned or NSF Checks

For all Checks returned to National Door marked NSF (Non-Sufficient Funds), we will add a \$35.00 service charge to your account balance. Returned checks will affect your credit standing and the sales terms we extend to you.

Stop Payment of Check

If for any reason you should stop payment on a check written to National Door, all account privileges will be automatically suspended, unless

previous arrangements have been made. All future orders will be shipped on a cash in advance basis.

CUSTOMER SERVICE

For your convenience, National Door's Sales Department will be happy to help you with any of the following:

1. Checking on orders or back orders
2. Advising shipping dates and tracking information
3. Providing quotes and freight estimates
4. Canceling orders
5. Verifying shortages
6. Handling damages
7. Providing proof of delivery

If you require any of the above services, please call and ask for our Customer Service/Sales Department. When you call in for any of these services, please have the following information available, as it will be necessary to process your request:

- a. Account Number
- b. Company Name
- c. City and State
- d. Area code and telephone number
- e. Your name (person calling or contact)
- f. P.O. Number (if used)
- g. Order Number or Invoice Number (for backorders)
- h. Shipping date (if shipped) or approx. order date
- i. Products that you are looking for

Give us this information, and many times we can give you an answer immediately.

Canceling Orders

If you would like to cancel your order, call Customer Service immediately. If the order is made to order, it might be too far into production and cannot be canceled.

Verifying Shortages

A shortage must be reported immediately, or it might adversely impact the claim process. Every shipment contains a packing list; Care should be taken to ensure that the list corresponds to the container contents.

There are two types of shortages: (1) a carton shortage, and (2) a contents shortage. We will cover each one separately.

1. Carton Shortages

All shipments move F.O.B. our warehouse unless otherwise stated. Goods in transit are the property of the consignee. The responsibility for shortages falls on the customer. Check your freight bill for carton count to insure all packages are delivered. If the shipment comes up short, have the driver note the shortage on the freight bill and sign it. Then immediately contact the carrier advising them of the shortage. However, on reorders you will be responsible for any freight charges. Please note that claim processing can take up to 120 days.

Terms and Conditions of Sale

Ground and Air Service: Many orders shipped from our warehouse via UPS/FedEx consist of more than one carton. A packing slip is attached to one of the cartons. When a shipment arrives, check the number of cartons shipped by looking at the packing slip. If you do not get a packing slip and feel you are short cartons, call our Customer Service Department; they will check the original sales order and advise you of the number of cartons shipped. Before you ask to have missing cartons traced, be advised, cartons can get separated during transit.

If you cannot wait for the merchandise, you can reorder from our Sales Department; however, you will be responsible for any freight charges on the reorder, or return of material if both orders arrive. If the short cartons never show up, ask Customer Service to file a claim for you.

2. Contents Shortages

When you receive a shipment, you should immediately check all merchandise against your packing slip to be sure all material is received. This is very important, as some carriers will not accept a claim if it is not filed within a specific time frame from the receipt of the shipment. If a box breaks open, some carriers will just reseal it with tape, and will not make a notation that the carton has been opened. Please check the contents of the box with this type of resealing immediately. If you notice a shortage, be sure to save the shipping carton and all packing material and contents for the carrier's inspection, or your claim may be denied. Any claim should be reconciled with the carrier. If you run into any problems, please feel free to call our Customer Service Department.

Before claiming a shortage:

- Check to be sure you have received all the cartons that were shipped.
- Check invoice to be sure that the items you feel you are shorted were not back ordered or cancelled.
- Check to see if all packing material has been inspected for merchandise.
- Make sure that none of your other personnel have removed a carton or contents before the merchandise was totally checked in.
- Check the cartons thoroughly to see if they were broken or damaged so you can determine who is responsible for the shortage—the carrier or the shipper.

Handling Damages

These are two types of damages, apparent and concealed. Both are covered below:

1. Freight and Common Carrier Damages

Material is shipped F.O.B. our warehouse unless otherwise stated. Goods in transit are property of the consignee (customer). The responsibility for damages and claims is the sole responsibility of the customer. It is important that goods be checked immediately for concealed damage, as a freight line will not accept claims for damage of

this type after 10 days of receipt. Check all packages for signs of damage before signing the freight bill and take pictures of any damage. Have the driver mark the freight bill if damage is apparent, and immediately contact the carrier.

- Original NDI invoice, to verify the value.
- The freight bill signed short or damaged.
- The original shipping containers and damaged goods. Payment will be made directly to you from the freight company. DO NOT return goods to National without written authorization.

2. UPS/FedEx Damages

When a UPS shipment arrives, it is extremely important that you check each package for signs of damage. Notify National Door immediately if you wish goods to be reshipped. Due to UPS/FedEx regulations, National Door will be responsible for filing the claim and credits will be issued accordingly.

Retain all damaged goods, cartons, and packing materials. Take pictures of all sides of the damaged box, including packing material. Send pictures to the Customer Service Department.

Tracing Shipments and Proof of Delivery

Our Customer Service Department will be glad to trace any shipment for you.

METHODS OF SHIPMENT

All shipments move F.O.B. our warehouse unless otherwise specified. Shipments will be made in any manner requested by the customer. In the absence of routing instructions, we will ship via the least expensive way. We usually try to ship all orders UPS or FedEx, if size and weight permit. Because of size or weight restrictions, we often have to ship via common carrier. As a service to you, we can designate your choice of common carrier on your account. If you wish to ship via a certain common carrier, call our Customer Service Department and ask them to put this carrier's name into your account master. The following are the different shipment methods available for your orders:

UPS/FedEx Regular Service

Serves the 50 contiguous United States. We find that this service for small packages gives the best result and we use it whenever possible. However, we are limited by the following:

- Maximum weight per package is 150 pounds (interstate).
- Maximum size per package is 165", length and girth combined. The maximum length on any package is 108".

Hundred Weight

The UPS hundred weight program is a cost effective method of shipment, priced by weight rather than by package. In many instances for shipments in the range of 151 to 500 pounds, may be more cost effective than common carrier. We can help you with this decision.

Air Freight

We can ship Next Day Air, 2nd Day Air, and 3rd Day Air. Air Freight Orders must be placed with National Door before 12:00 pm CST, to ensure service.

No aerosol cans or hazardous materials can be shipped via Air.

Parcel Post

We discourage the use of this service due to the unusual delays and damage in shipping.

Motor Freight or Common Carrier

We ship by freight lines when weight and size limitations require that we do so. If you wish your shipment to go by a specific freight company, you may request it and we will make every effort to ship your order by that carrier.

MISCELLANEOUS CHARGES

Broken Lot Charge - 15%

Most of the items in our catalog have standard packaging quantities. These quantities are published in the catalog directly next to the subject items. A 15% broken lot charge will be added to an item below the published package quantity. Some items are not sold below package quantity. This charge applies to all orders unless otherwise stated.

Cutting Charge - \$16.00

National Door will add a \$16.00 cutting charge to any order that requires stock lengths to be cut. This cutting charge is a per-item charge. This service is offered to our customers to more economically ship stock length material. We reserve the right to charge additional cutting charges should customers require more than 10 pieces per item for cutting. When large quantities are involved, we recommend our customers cut their own extrusions from stock lengths.

Drop Shipment Charge - \$15.00

National Door will add a \$15.00 drop shipment charge to any order that ships to a location that doesn't belong to the customer.

Setup Charge on Discontinued Items

National Door will add a variable setup charge to any order that include window frames or design trim for discontinued or obsolete products. The setup charge is variable depending on the item and quantities ordered.

Electronic Commerce User Agreement

Grants access to our online ordering system

Complete the below section, have the Agreement signed by an authorized signator and either fax it or mail it to National Door Industries, Inc. ("National"). We will process your request and contact you to begin your service. Read all terms and conditions of this Agreement before signing, opening any software media package or accessing the National Web Site or any Informational Database. By opening any software package or accessing the Web Site or Informational Database, your organization ("you") agree to these terms and conditions, as modified or amended from time to time and each time you access the Database, Software or the Site, you reconfirm your agreement. If you do not agree to these terms and conditions, you may elect not to access the Database or Site, and must, if applicable, return any accompanying software product container and its contents, including any unopened software media package, to National. This Agreement is effective from the day you initially use or install the Software, access the Database or Site until such time as you cease to be an authorized reseller of National.

1. **Definitions.** For purposes of this Agreement, the following definitions shall apply: (i) **Site or Web Site.** The Site or Web Site means all information, content, concepts, program interfaces, structures, functionality, computer code, published materials, electronic documents, graphic files and other technology inherent in National's World Wide Web Site located at www.natdoor.com, dealer.natdoor.com, or customer.natdoor.com. (ii) **Software.** The Software, if any, includes all concepts, users and program interfaces and structures, functionality, computer code and other technology inherent in all computer software programs and all copies of the software supporting any of National's electronic commerce tools and products. You may make and maintain one copy of the Software per employee making authorized use of the Software. (iii) **Databases or Informational Databases.** The Informational Databases or Database includes all information accessible from National through the Software or the Site, which may include, but is not limited to, data structures, technical and other specifications, pricing, advise, and other data and information. All data and other information available on the Informational Databases is proprietary, confidential and the sole property of National or third parties licensing such information to National.

2. **Security.** You must enter a valid user ID and password ("access codes") to use certain Software, access some of the Databases or access the Web Site's secure areas. It is your sole responsibility to monitor use of these access codes for all purposes, including, but not limited to ordering. You accept all responsibility for the security of your user ID and password, and utilization of the Software, Informational Databases or Web Site via the access codes. This includes unauthorized access by your employees or third parties, except for access by third parties resulting from National's sole negligence. You have the ability to modify your password at any time. National recommends you modify your password regularly. Notify National immediately if you wish to terminate your master user ID and password or have these access codes reissued. Do not disclose your access codes to anyone not authorized to act on your behalf.

3. **Order Validity.** You agree not to contest the validity or enforceability of orders placed via the Software or through the Web Site's secure areas under the provisions of any applicable law. All orders placed using the user ID and password shall, for all purposes, be deemed to be in writing signed by you and will be admissible as between the parties to the same extent and under the same conditions as other business records originated and maintained in documentary form.

4. **Terms and Conditions of Sale.** Unless otherwise stated in an express written agreement signed by an officer of National, the terms and conditions contained on National's written invoices, the catalog, and available on line, as amended from time to time, shall apply to all transactions initiated via the Software or through the Web Site. National's terms and condi-

tions of sale may vary depending upon the country from which you are ordering or the subsidiary with whom you do business. ALL SALES TRANSACTIONS EXCLUDE THE APPLICATION OF THE 1980 UNITED NATIONS CONVENTION ON CONTRACTS FOR THE INTERNATIONAL SALE OF GOODS, IF OTHERWISE APPLICABLE.

5. **Termination and Modification.** National may elect to update, modify, change or terminate all or any part of the functionality available through the Software or Informational Databases or Site, including modification or termination of the ability to place orders or make inquiries at any time in the future. National may modify this Agreement from time to time. Any amendments or modifications may be provided to you through on-line notice. You agree that use of the Software or access to the Informational Databases or Site after you have, or should have received, notice of modifications or amendments to this Agreement will constitute acceptance of all such modifications or amendments. You agree on termination of this Agreement immediately to cease accessing the Informational Databases and to return any Software provided. The Software, Informational Databases, and the Site's secure areas are confidential information of National or companies licensing National and contain copyrighted information.

6. **License.** The Software and Informational Databases are not sold but licensed to you for your internal use in your ordinary course of business for your review, selection, order preparation, support and purchasing of products sold by National. This license is for the period beginning with your acceptance of this Agreement until termination by you for failure to maintain authorized reseller status; is non-transferable and non-exclusive; and is for use only by your employees engaged in your reseller business, and only in accordance with this Agreement and any documentation provided to you or available on-line from time to time. You may NOT, except as otherwise provided in the documentation or on-line (a) copy any of the Site, Software or Informational Databases; (b) distribute, rent, sublicense or otherwise transfer or disclose, or (except to access the Database in accordance with the documentation) transmit the Site, Software or Informational Databases electronically to any person or entity; (c) modify, translate, merge, or prepare derivative works of the Site, Software or Informational Databases; or (d) use any of the Site, Software or Informational Databases for service bureau or other purposes not specified in this Agreement or the documentation. You may not decompile, disassemble, probe, or otherwise reverse engineer the Software, Informational Databases or the Site.

7. **Disclaimer of Warranty; Limitation of Remedies.** National is licensing the Software, Informational Databases and Site "AS IS" and "AS AVAILABLE." You acknowledge that the Site and/or Software are licensed for use by you as a convenience for you in communicating with National. You assume total responsibility and risk for your use of the Software, Informational Databases, Site and your use of the Internet. NATIONAL HEREBY DISCLAIMS ALL WARRANTIES, REPRESENTATIONS AND CONDITIONS, STATUTORY OR OTHERWISE, EXPRESS OR IMPLIED, INCLUDING, BUT NOT LIMITED TO, THE IMPLIED WARRANTY OF MERCHANTABILITY AND FITNESS FOR A PARTICULAR PURPOSE WITH REGARD TO ANY MERCHANDISE, INFORMATION OR SERVICE PROVIDED THROUGH THE SOFTWARE, SITE OR INFORMATIONAL DATABASES. National shall not be liable to you or any third party for any damages arising from or as a result of any delay, omission or error in electronic transmission or receipt of any orders or otherwise made pursuant to the Software or via the Site, even if advised of the possibility of such damages. THE DATABASE CONTAINS INFORMATION OBTAINED BY NATIONAL FROM MANUFACTURERS AND OTHERS THAT INDUSTRY SOURCES BELIEVE WERE RELIABLE, BUT NATIONAL MAKES NO WARRANTY AND DISCLAIMS ALL WARRANTIES AND LIABILITY REGARDING DATABASE ERRORS AND OMISSIONS, AND IT IS SOLELY YOUR RESPONSIBILITY TO EVALUATE THE ACCURACY, COMPLETENESS AND USEFULNESS OF ALL OPINIONS, ADVISE, SERVICES OR OTHER INFORMATION CONTAINED IN THE INFORMATIONAL DATABASES AND THE SITE. You agree that the Site

Electronic Commerce User Agreement

and/or Software give you significant benefit for no or a modest economic consideration. Your sole and exclusive remedy for any breach of this Agreement by National shall be to terminate the Agreement and the return of any license fee paid by you to National. IN NO EVENT WILL NATIONAL BE LIABLE FOR ANY DIRECT, INDIRECT, SPECIAL, INCIDENTAL, PUNITIVE OR CONSEQUENTIAL DAMAGES ON ANY LEGAL THEORY WHETHER IN CONTRACT, TORT, EQUITY OR AT LAW, EVEN IF ADVISED OF THE POSSIBILITY OF SUCH DAMAGES. Additional Disclaimers may be contained in the Software, Site and Database.

8. Governing Law. This Agreement and your use of the Software, Informational Databases and Site are governed by internal Texas law and applicable federal laws of the United States. The venue for any disputes arising out of this Agreement shall be, at National's sole and exclusive option, the courts with proper jurisdiction at National's corporate headquarters.

9. Your Obligations. You agree that you shall not use the Software, Informational Databases or Site to do any of the following: (i) restrict or inhibit any other user from using and enjoying the Internet, Site, Software or Informational Databases; (ii) post or transmit any unlawful, illegal, obscene or pornographic information of any kind, including, without limitation, any transmissions constituting or encouraging conduct that would constitute a criminal offense, give rise to civil liability or otherwise violate any local, state, national or international law, including, without limitation, the U.S. Export Control laws and regulations; (iii) knowingly post or transmit any information or software which contains a virus, worm, cancelbot or other harmful component; (iv) upload, post, publish, transmit, reproduce, distribute or participate in the transfer or sale, or in any way exploit any information, software or other material obtained through the Software, Site or Informational Databases which is protected by copyright or other proprietary right or derivative works with respect thereto, without obtaining permission of the copyright owner or right holder. In addition, you may not effect or participate in any activity to (a) post to any usenet or other news

group, forum, Email listing or similar group or list, articles which are off topic according to the charter or other public statements of the group or list; (b) send unsolicited mass mailings; or (c) falsify or "spoof" user information provided to National or to other users in connection with the use of Software, Informational Databases or Site.

10. Indemnity. You agree to defend, indemnify and hold National and its affiliates, and its and their directors, employees and agents harmless from any and all liabilities, costs and expenses, including reasonable attorneys' fees related to or arising from (a) the use of the Software, Informational Databases or Site or the placement or transmission of any message, information, software or other material on the Site by you; (b) negligent acts or omissions by you in connection with the installations, use or maintenance of the Software, Informational Databases or Site; (c) claims for infringement of patents arising from the use of the Software, Informational Databases or Site by you, and (d) claims of copyright infringement resulting from the use of the Software, Informational Databases or Site by you.

11. Pricing. National provides access to product and pricing information on an international basis as a result of making such information available on the World Wide Web. Such information may contain references or cross references to products, programs, prices, promotions and services that are not announced or available in your country. Such reference does not imply that National intends to announce or make available such products, programs, promotions or services, under such prices in your country. Any promotions may not apply in your geographic region. Please check with your National representative regarding product availability, pricing and promotions and the availability thereof in your geographic area. The products listed in the Informational Databases may not be available in your location due to specific legal requirements related to export restrictions and other legal or contractual requirements imposed upon National or of your geographic location. National assumes no responsibility for being unable to provide products or services due to such legal or contractual requirements. You assume all responsibility for obtaining all necessary approvals to obtain National products or services.

Company Information

Company Name: _____
Address: _____
City: _____ State: _____ Postal Code: _____
Country: _____ Phone: _____ Fax: _____

Individual Information

Name: _____ Title: _____
Phone: _____ Fax: _____
E-mail: _____

Please provide your own individual company e-mail address. The same email address can not be used for multiple accounts.

Applicant's Signature: _____

By signing, you agree to the terms and conditions stated in the Elcetriconic Commerce Agreement located above.

Executive Authorization

Executive's Name: _____ Phone: _____ Fax: _____
Executive's Signature: _____

By signing, you agree to the terms and conditions stated in the Elcetriconic Commerce Agreement located above.



Super-Duty Punched Angle Shear - 162100

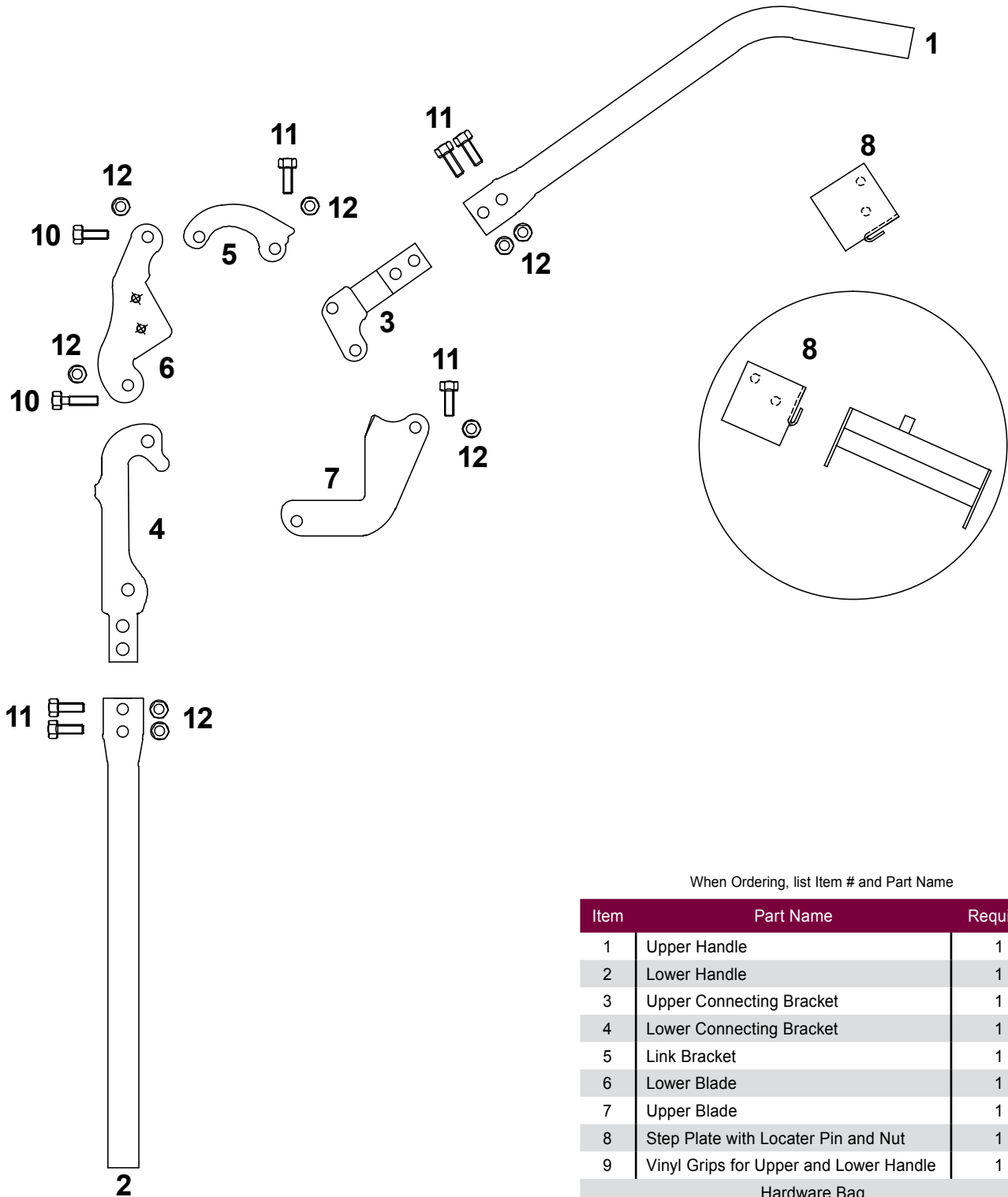

When Ordering, list Item # and Part Name

Item	Part Name	Required
1	Upper Handle	1
2	Lower Handle	1
3	Upper Connecting Bracket	1
4	Lower Connecting Bracket	1
5	Link Bracket	1
6	Lower Blade	1
7	Upper Blade	1
8	Step Plate with Locater Pin and Nut	1
9	Vinyl Grips for Upper and Lower Handle	1
Hardware Bag		
10	1 1/2" x 1/2" Hex Head Bolt	2
11	2" x 1/2" Hex Head Bolt	6
12	1/2" Lock Nut	8

Roper Whitey # 7A Punch Parts List - 162700

When Ordering, list Item # and Part Name

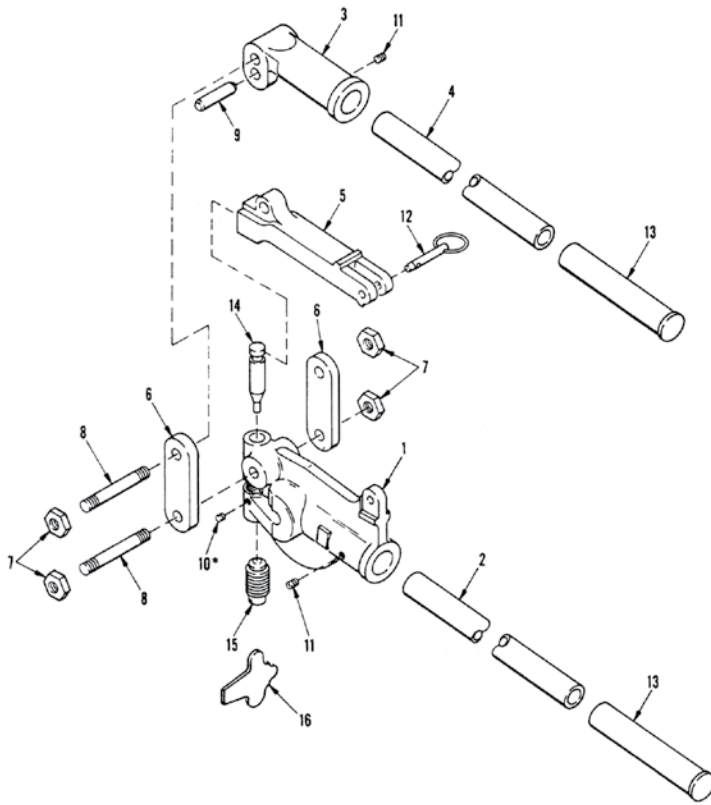

Item	Catalog	Part Name	Required
1	730140183	Frame "C"	1
2	730460184	Handle - Lower Extension	1
3	730460185	Handle - Operating	1
4	730460186	Handle - Operating Extension	1
5	591000003	Arm - Eccentric	1
6	730240187	Link	2
7	730160042	Nut	4
8	730160188	Pin - Link	2
9	600053340	Pin - Dowel, Hardened	1
10	600325902	Screw - Set, Headless	1
11	621012124	Screw - Soc. Set. Cup Pnt.	2
12	600083602	Pin - Detent	1
13	656356301	Grip	2
14	300070219	Punch	1
15	310070219	Die	1
16	730480009	Wrench - Die Adjusting	1
17	139020070	Bench Mounting Base	0

* Note: When using irregular shaped punches and dies, screw (10) must be used in position shown to prevent the die from turning.

Roper Whitney #8 Punch Parts List - 162900

When Ordering, list Item # and Part Name

Item	Catalog	Part Name	Required
1	730460050	Lower Handle	1
2	730460051	Upper Handle	1
3	730160052	Bolt	2
4	730650053	Handle Screw	1
5	730240054	Side Link	2
6	730560055	Nut	4
7	730030056	Arm	1
8	600255201	Roller Bearing	34
9	730210057	Cam	2
10	600255202	Pin	2
11	730260058	Roller Retainer	2
12	730480009	Key	1
13	600325903	Set Screw	1

* Note: When using irregular shaped punches and dies, screw (13) must be used in position shown to prevent the die from turning.

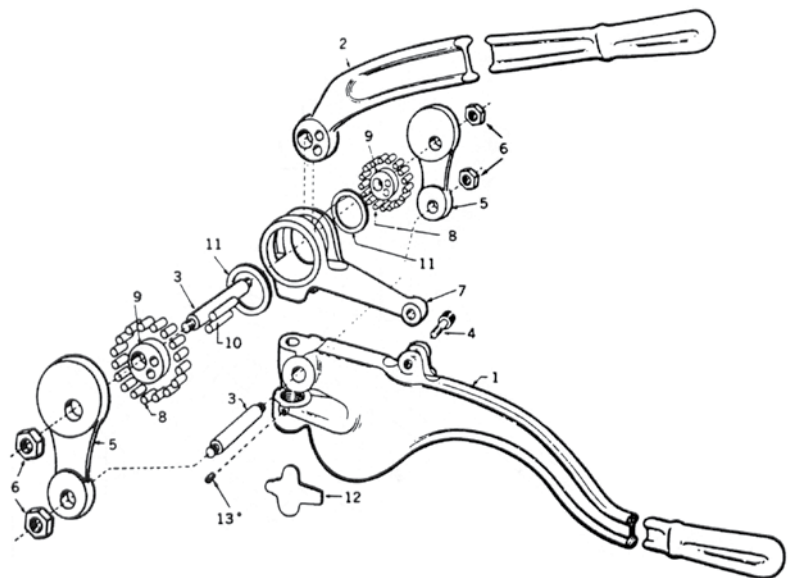

Roper Whitney #4 Shear Parts List - 162400

When Ordering, list Item # and Part Name

Item	Catalog	Part Name	Required
1	740060015	Base	1
2	740830019	Hinge Bolt Washers	3
3	652023010	Hinge Bolt Nuts 3/4-16 Jam	4
4	633012279	Support Stud Adjusting Screw 1/2-13x2 Square Head	1
5	649023007	Support Stud Adjusting Screw Nut 1/2-13 Hex Jam	1
6	740160020	Work Support Stud	1
7	649023010	Support Stud Nut 3/4-10 Hex Jam	1
8A	250004150	Die Segment Set	Set
8	740120021	Long Die Segment	1
9	740120022	Short Die Segment	1
10	613012089	Die Mounting Screws 1/4-20x3/4 Flat Head	4
11	740160018	Hinge Bolts	2
12	740670017	Operating Handle	1
13	740060026	Gear Flange Support	1
14	740083025	Hinge Bolt Washer	1
15	600063477	Gear Flange Support Pin 5/16x1 Roll Pin	1
16	740030016	Movable Shear Arm	1
17	350004070	Movable Shear Blade	1
18	613012179	Shear Blade Screw 3/8-16x1-1/2 Flat Head	1
19	649023005	Movable Shear Blade Screw Nut 3/8-16 Hex Jam	1
20	600063477	Shear Blade Pin 5/16x1 Roll Pin	1
21	350004025	Movable Blade for 2x2x1/8 Angle	1
22	350004060	Base Shearing Die (Old Style)	1
23	740650057	Base Shearing Die Screws (Old Style)	3
24	740460027	72" Bar Handle (Not Shown)	1

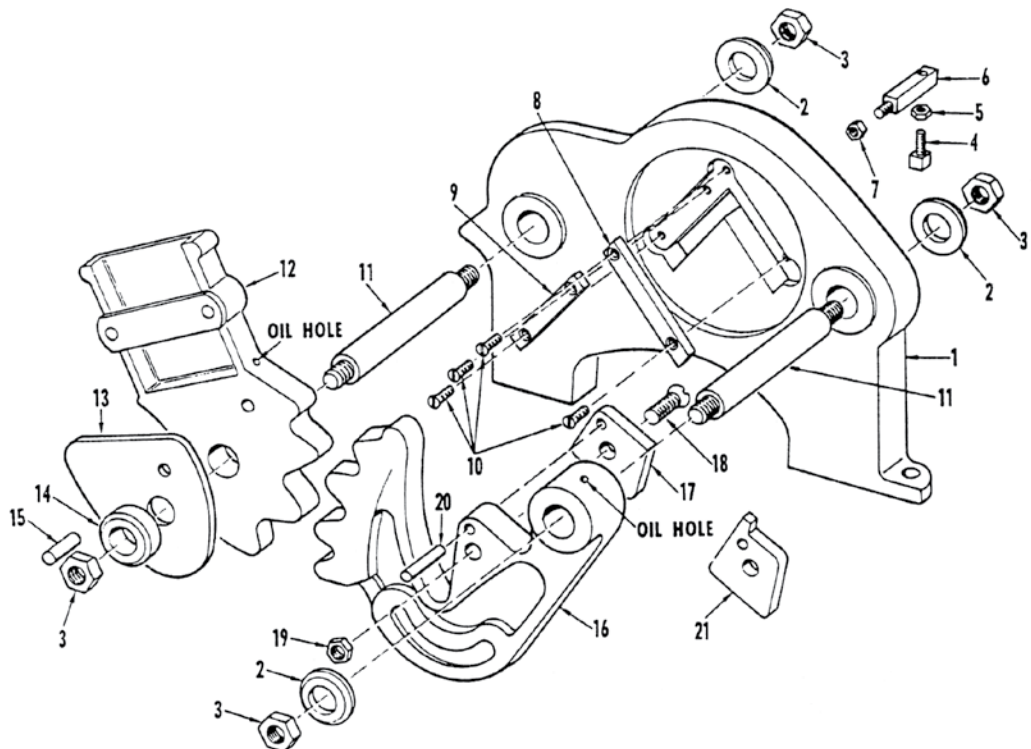
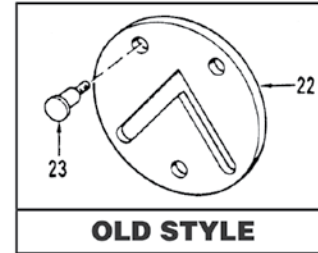

National Door Catalog Index

A

Adapter Rails.....	81
Adjustable Bottom Rail	75
Aluminum Retainers	76
Anchors	
Plastic Drive.....	12
Plastic Screw.....	12
Sleeve.....	11
Wedge Stud	11
Angle Iron	
Punched.....	27
Aviation Snips	53

B

Backskin Retainer Clips	78
Bolts and Screws	
Carriage Door Screw.....	88
Deep Indented Lag Screw	8
Drill-Quick Screw	9
Eye Bolt.....	24
Flat Head Carriage Bolt	10
Hex Head Bolt.....	10
Hex Head Screw.....	8
Hex Washer Head Screw	8
Hex Washer Head Drill Point Screw	9
Hex Washer Tapping Screw.....	9
Ribbed Neck Track Bolt.....	8
Square Head Set Screw.....	9
Tek Screw.....	9
Brackets	
Adjustable Reinforcing.....	22
Carriage Door.....	83
Commercial Bottom.....	21
Commercial Top.....	24
Flag.....	27
Jamb.....	24
Low Headroom.....	23
Low Headroom Top.....	25
Operator Reinforcing.....	22
Outside Hookup Bottom	23
Outside Hookup Stopping Bottom	24
Quick Closing Top Fixture.....	23
Residential Bottom	21
Residential Top.....	24
Spring Anchor.....	25
Stainless Steel.....	41
Steel Door Commercial Top.....	24
Stopping Bottom.....	21
Bumpers	
Push Down.....	19
Spring.....	19
Stainless Steel.....	42

C

Cable	
Bulk Cable.....	15
Button Stops.....	14
Cable Sets	15
Clamps.....	14
Come A-Long.....	54
Cutter	56
Drums.....	36-37
Duplex Sleeves.....	14
Felco Cutter	56
Grips.....	54
Keeper.....	21
Spools.....	14
Stainless Steel.....	44
Swaging Tool.....	55
Thimbles.....	14
Carriage Door Clavos	
Pyramid.....	88
Round.....	88
Carriage Door Corner Brackets	
120° Corner.....	87
90° Corner	87
Carriage Door Design Trim	
Rectangular Top 13" Height.....	134
Rectangular Top 16" Height.....	135
Carriage Door Frames	
Rectangular Top 13" Height	112
Rectangular Top 16" Height	113
Carriage Door Handles	
Hammered Iron Lift.....	87
Magnetic Polymer.....	84
Polymer.....	85
Stamped Steel Lift.....	86
Carriage Door Hinges	
Hammered Iron Bean Head.....	87
Hammered Iron Fleur-de-lis.....	87
Hammered Iron Spear.....	87
Hinged Hammered Iron Spear	87
Magnetic Polymer Spear	84
Polymer Spear.....	85
Stamped Steel Bean Head	86
Stamped Steel Fleur-de-lis	86
Stamped Steel Heritage.....	86
Stamped Steel Strap.....	86
Carriage Door Knockers	
Hammered Iron Door.....	88
Stamped Steel.....	86
Carriage Door Screws	88
Carriage Door Studs	88
Chain	
Breaker	86

Hoist Sprockets.....	29
Hoists.....	28-29
Holder.....	56
Keeper.....	30
Latch.....	25
Master Links	30
Offset Link	30
Puller	56
Roller.....	30
Roller Links.....	30
Tensioner.....	29

Clamps

Vise Grip	55
-----------------	----

Clevis Pin.....

Controls

Emergency Egress.....	2
Explosion Proof	2
Exterior Station	2
Flush Mount - Exterior.....	3
Flush Mount - Interior.....	3
NEMA 1 Interior	3
NEMA 4 Exterior	3
NEMA 4 Mushroom Head	3

Cords

Coil Cord.....	5
Cord Reel.....	5

Cotter Key.....

Counter Balance Arm.....

Couplings

Adjustable Shaft.....	38
Solid.....	38
Tube.....	38

Cylinder Lock.....

D

Degreaser.....

Design Trim

Amarr	121
Carriage Door.....	134-135
CHI	122
Clipay	123
Delden	124
DoorLink	125
First United Door Technologies.....	126
General Door.....	127
Haas.....	128
Mid-America.....	129
Overhead Door.....	130-131
Richards-Wilcox	132
Windsor	133

Drill Bits.....

Drivers.....

National Door Catalog Index

E

Electrical Plugs.....5

F

Fasteners8-10

G

Gate
 Free Exit Sensor 138
 Operator 137
 Receiver 138
 Solar Panel..... 138
 Transmitter 138

Glass 117

Glass Cleaner47

H

Hand Cleaning Wipes.....49

Handles
 Carriage Door.....86
 Drop Lift.....19
 Dummy-T.....18
 Inside Release.....18
 Junior Release.....18
 L Type Locking.....17
 Outside Lock.....16
 Rolled Lift.....19
 T Type Locking17

Hex Drivers60

Hinges
 Carriage Door.....86
 Narrow Body20
 Stainless Steel.....42
 Wide Body20

Hole Saws.....62

I

Insulation.....80

K

Key Stock.....38

L

Latches
 Automatic Spring Latch.....18
 End Stile Lock.....16
 Nite Latch17
 Side Lock Set.....16
 Slide Latch.....16
 Sliding Bolt16
 Spring Latch17

Lock Bar
 Bar.....19
 Disc.....18
 Guide.....19
 Spacer.....19

Locks
 Cylinder Lock.....17
 Dummy T Handle.....18
 L-Type Handle17
 Outside Handle.....16
 T-Type Handle17

Loop Detector.....4

Lubricants
 40047
 400 Xtreme Duty.....47
 800 Food Grade48
 90048
 GDL-1000.....48
 Lock Ease50
 Lubriplate50
 Private Label46
 Stick.....50

N

Nails
 Weatherstrip 10, 65

Nuts
 Flanged Lock.....9
 Hex9
 KEP9

O

Operators, Gate..... 137-138

P

Plastic Backskin78

Plates
 Step.....27
 Track Splice.....24

Pull Rope.....25

Punched Angle Iron.....27

Pulleys
 Sheaves.....26

Punches
 Roller Bearing.....53

R

Retainer Clips78

Reverse Angle Weatherseal74

Rivets
 Pop Rivets12
 Tools.....59

Rollers
 Car Wash.....20
 Stainless Steel.....44
 Track.....20
 Truck Door.....31

Rolling Steel Weatherseal
 Bottom Seal82
 Guide Seal82
 Top Seal.....82

Rope
 Cotton Sash.....25
 Pull Rope25

S

S Hooks.....25

Saw Horse.....58

Screws
 See Bolts and Screws

Section Sealing Strip.....78

Shaft Bearings26

Shaft Collars38

Shears
 Big Red.....52
 Super Duty.....52
 Open Throat.....52
 Whitney.....53

Sheaves.....26

Sliding Doors
 Blind End.....40
 Door Stop.....40
 Double Track Brackets40
 Hangers.....39

National Door Catalog Index

- Offset Roller40
- Single Track Brackets40
- Track.....40
- Trolleys.....39
- Sockets**
- Adapter.....61
- Driver.....60
- Extensions.....60
- Magnetic Impact.....60
- Non-Magnetic Impact.....61
- Spreader Bar Set.....30**
- Springs**
- Anchor Brackets.....25
- Cones.....33
- Extension.....34
- One-Piece.....34
- Repair Blocks.....57
- Torsion.....35
- Wire Gauge.....57
- Stainless Steel**
- Bearing.....42
- Bearing Plates.....43
- Bottom Bracket.....41
- Cable.....44
- Hi-Lift Plates.....42
- Hinges.....42
- Key Stock.....42
- Low Headroom Bracket.....41
- Pusher Springs.....42
- Rollers.....44
- Top Bracket.....41
- Torsion Shafts.....42
- Staple Gun.....58**
- Staples.....58**
- Studs**
- Carriage Door.....88
- Stop Mould**
- Jambup.....73
- Supports**
- Center.....27
- Flanged End Bearing.....26
- Flat End Bearing.....26
- Stainless Steel.....43
- Switches**
- Emergency Disconnect.....4
- Flush Mount.....2
- Key Switch.....4
- NEMA 4 Ceiling Pull.....3
- Post Mount.....3
- Push Button.....4
- Surface Mount.....2

T

- Threshold**
- Aluminum.....79
- Vinyl.....79
- TODCO Truck Door Parts.....32**
- Threshold**
- Aluminum.....79
- Vinyl.....79
- Tools**
- Come A-Long.....54
- Cutters.....53
- Grips.....54
- Rivet Guns.....59
- Shears.....52
- Snips.....53
- Swagging Tool.....55
- Torsion Shafts.....38**
- Torsion Tubes.....38**
- Track**
- Sections.....27
- Straightening Tool.....57
- Truck Door Parts**
- Rollers.....31
- TODCO.....32
- WHITING.....31

U

- Universal Adapter Rails.....78**

V

- Vent Kits.....117**
- Vinyl**
- Beaded End.....71
- Double T.....71
- Single T.....71
- Threshold.....79

W

- Washers**
- Flat.....10
- Lock.....10
- Weatherseal - Bottom**
- Aluminum Adjustable Bottom Rail.....75
- Aluminum Weatherseal Retainer.....76
- Clip-Install.....77
- Plastic Weatherseal Retainer.....76

- Polar Bottom Seal74
- Rubber Astragal.....73
- Sectional Bottom Seal81
- Ship Lap Bottom Seal.....81
- Tongue and Groove Bottom Seal81
- Vinyl Bottom Seal71

- Weatherseal - Top/Side Seal**
- Brush Guide Seal.....72
- Door Header Seal.....74
- Jamb Up (Stop Mold).....64
- Jumbo Seal.....65-71
- Polar Jamb Seal.....72
- Reverse Angle Weatherseal.....74
- Sectional Top Seal.....80
- Vinyl Guide Seal.....72

- Weatherseal - Vinyl**
- Polar Stop Mold.....73
- Reversible Stop Mold.....73
- Stop Mold.....73

- WHITING Truck Door Parts.....31**

- Winding Bars.....60**

- Window Frames - Commercial**
- CMF.....114
- CWF.....115-116

- Window Frames - Residential**
- Aluminum.....111
- Amarr.....99
- Carriage Door.....112-113
- CHI.....100
- Clopay.....101
- Delden.....102
- DoorLink.....103
- First United Door Technologies.....104
- General Door.....105
- Haas.....106
- Mid-America.....107
- Overhead Door.....108
- Richards-Wilcox.....109
- Windsor.....110

- Wire.....5**

- Wire Nuts.....5**